

SAWTEQ S-300
proLine

Cutting forward.

SAWTEQ S-300 / S-310



SAWTEQ S-300 and S-310 – Maximum versatility

The SAWTEQ S-300 and S-310 saws combine performance, speed and reliable technology with intelligence and digital, self-learning functions. This is reflected, among other things, in an increased performance level with lower energy consumption and significantly improved ergonomics. Whether as a single saw with an integrated lifting table for the additional automatic feed via the rear of the saw or as an angular saw unit: the saws meet your needs perfectly. In addition to the comprehensive basic configuration, a wide range of optional features allow you to individually tune your SAWTEQ S-300 / S-310 to match the processes and tasks in your company.

YOUR SOLUTION

MORE AT HOMAG.COM



SAWTEQ S-300
and S-310

CONTENTS

- 07 Software
- 18 SAWTEQ S-300
- 20 SAWTEQ S-310 with lifting table
- 22 Standard features
- 30 Optional features
- 56 Technical data
- 58 Service

Sustainability meets intelligent technology: The new SAWTEQ S-300 / S-310



The basic models at a glance

- SAWTEQ S-300 as single saw
- SAWTEQ S-310 as single saw with lifting table

Feed options

Whether by hand, via a storage control connection or integrated lifting table. There are many technologies for feeding panels to choose from (page 31).

Saw design

The proven technology of the basic model of the SAWTEQ S-300 offers you maximum performance in the smallest of spaces. The SAWTEQ S-300 is also the basis for the SAWTEQ A-300 and A-310 angular saw units, which are designed for maximum precision in continuous operation.

For more information, see the SAWTEQ A-300/A-310 angular saw unit brochure.

Simple and intuitive machine operation

The CADmatic 5 saw control system has a new 3D assistance graphic that shows the machine operator all the steps clearly and in order.

NEW: quickTip — the assistant for optimal use of the machine functions (p. 07)

In addition, IntelliGuide Premium intelligently guides the operator through the cutting process quickly, easily and intuitively using laser projections directly on the workpiece (page 15).

Sawing sustainably

The optimized chip guide of the new SAWTEQ S-300 / S-310 reduces the required suction power by up to 12% and extends the tool life. In addition, our cutting optimization solutions and the increase in performance while maintaining energy consumption contribute to increasing global sustainability.

Increased performance

With optimized and further improved coordinated processes in the cutting cycle, the new series achieves a further increase in performance of up to 20% — especially for machines with Power Concept and storage control connection.

Long-term production at a consistently high quality

With materialManager Advanced, your machine automatically adjusts to the material correctly — depending on your quality requirements and saw blades (page 55).

NEW: The integrated "toleranceCheck" tolerance measurement directly at the right-angled fence ensures high-precision cutting and reliable processes (page 45).

Function expansion at the touch of a button

NEW: The new SAWTEQ S-300 / S-310 can be quickly and easily expanded with function+ in tapco countries. The machine grows together with your requirements — just when you need it (p. 09).



CADmatic 5 – intuitive to operate and open for digital networking

CADmatic 5 is the state-of-the-art, high-performance saw control system from HOMAG. It offers a wide range of functions and is easy to use thanks to the intuitive operating concept and clear management functions. What's more, CADmatic 5 is open for communication with other machines and software solutions.

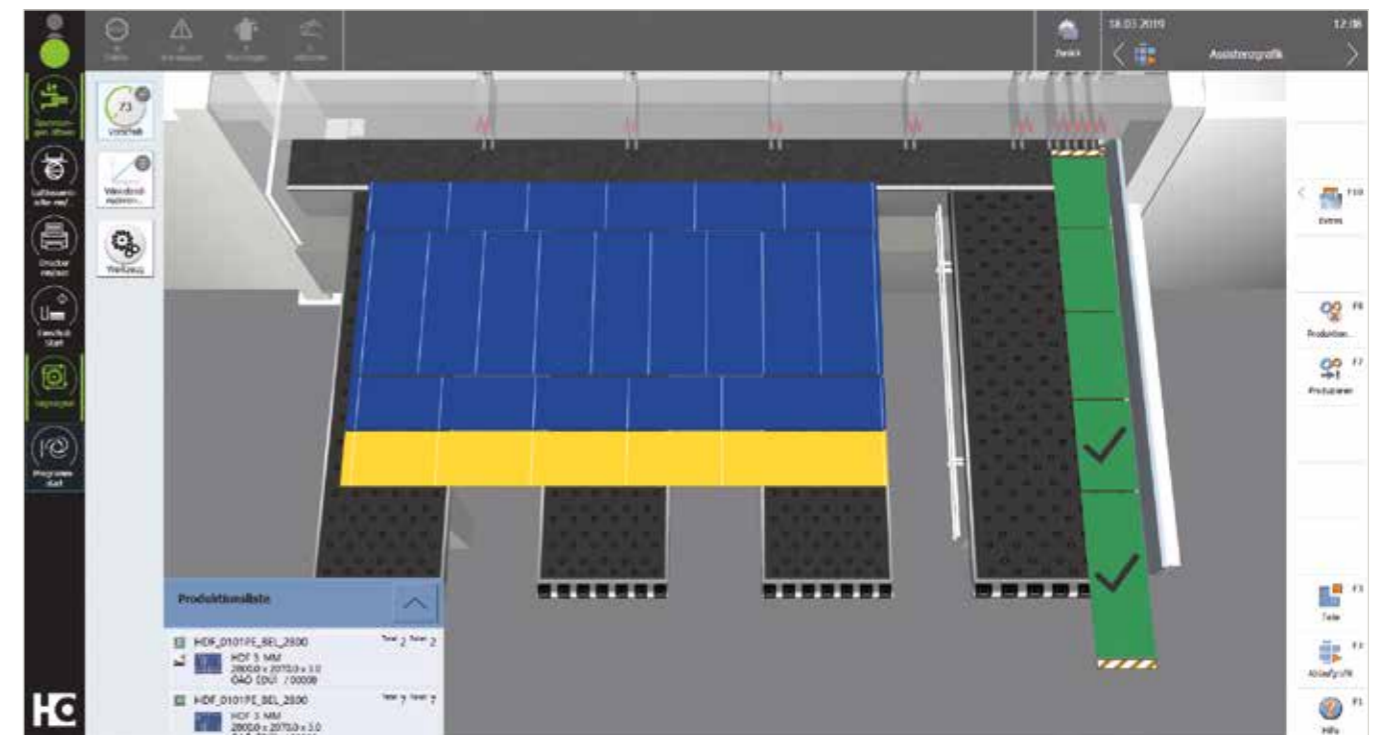

CADmatic 5 – the change in perspective

The latest generation of the HOMAG saw control system has a 3D assistance graphic that clearly shows the machine operator all the steps in order. It is intuitive to operate, which shortens the training time and reduces errors to a minimum.

NEW: quickTip – the assistant for optimal use of the machine functions

quickTip is a new assistance function integrated into the HOMAG saw control system for maximum quality, operating comfort and performance. It supports the machine operator by providing recommendations for optimal use of functions directly at the saw. The advantage is that the functions and parameters can be activated centrally at one single point in CADmatic – this simplifies work, ensures smooth processes and a uniformly high output.

Highlights:

- Simple, intuitive and ergonomic machine operation thanks to the 3D assistance graphic including quickTip
- The result: seamless processes and a steady output
- Swiveling and tiltable 24" full-HD multi-touch display in widescreen format is easy to use by swiping, scrolling and zooming
- Standardized operating concept thanks to the powerTouch user interface
- All HOMAG saws with CADmatic 5 are automatically tapio-ready

Find out more in the "CADmatic" brochure.

What's the difference? The software!

It efficiently integrates the machine into the production process. This results in seamless, intelligently networked processes from start to finish. In short: the right software unlocks new value-added potential. That is what makes it so important.



Next generation of powerTouch: **powerTouch2**

Faster, clearer, easier to use: Enjoy the benefits of our further improved powerTouch user interface. We have optimized our standardized operating concept and further adapted it to our customers' needs. You can now control your HOMAG machines even faster and more intuitively. The new, modern design is clearly structured. The innovative touch operation is designed to enable you to achieve the desired result easily and conveniently.

With the new powerTouch generation, you can enter information on the machine more quickly. Time savings of up to 30% can be achieved compared to the previous version. This is possible thanks to new features, such as auto-complete, a pop-up keyboard that can be kept open and Windows-like functions, such as the selection of common actions directly via the start button.

Our successful powerTouch philosophy — **simple, standardized, ergonomic, evolutionary** — systematically enhanced

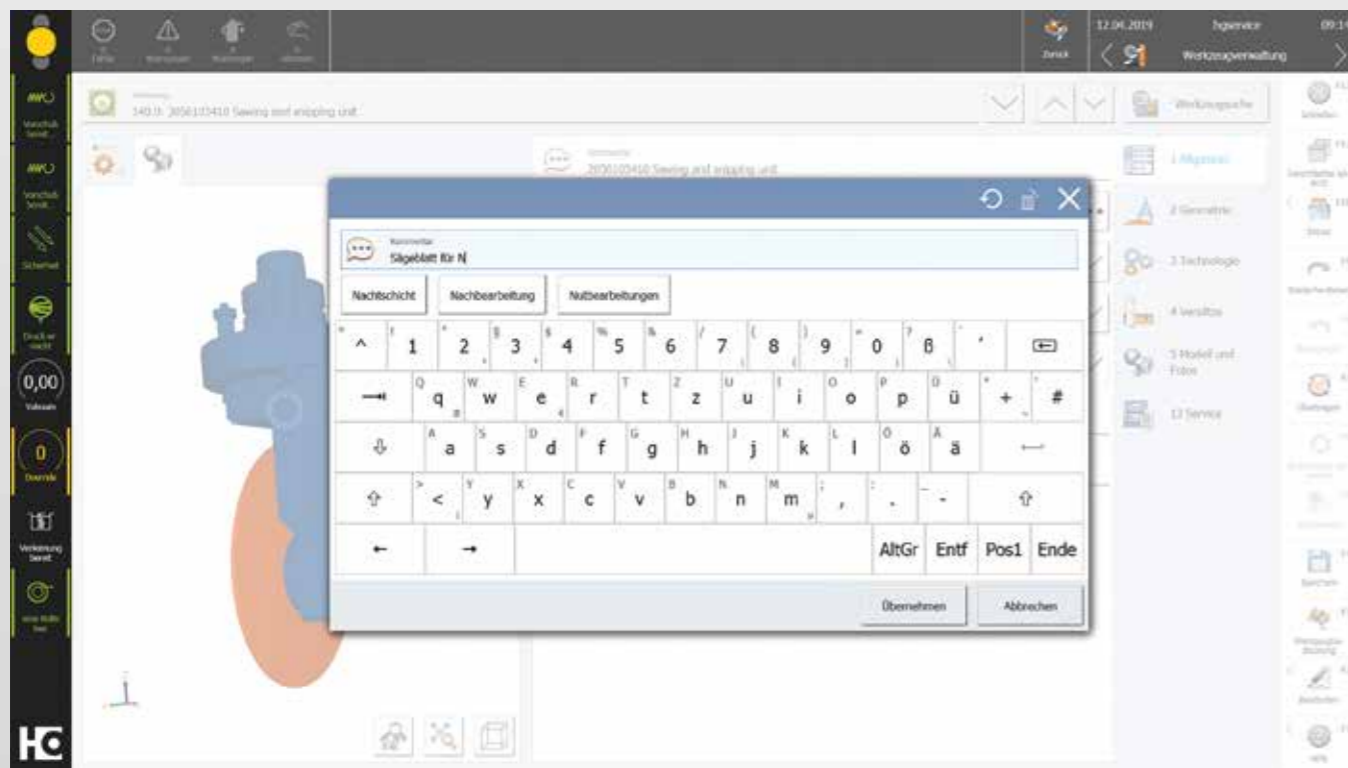

1 The powerTouch2 screen is clearly laid out and logically structured. You can see all the key information at a glance, but you still have all the details.

3 Functional pop-up keyboard that can be kept open, including auto-complete for faster input (when you enter the first few letters, frequently used applications are suggested and you can select them directly).

2 We have also improved the traffic light dialog again. You can now directly influence the machine's production readiness by selecting actions via the traffic light icon.

4 Enhanced "Start" menu that displays additional information (e.g. indicates how many messages there are, or has status bars that show how far the application has progressed) and allows actions to be called up directly (e.g. confirm actions without having to go to the application).



Boosting your flexibility: **function+**

Successful entrepreneurs know that the perfect machine grows with the business. If the requirements change, it adapts. Ideally, at the touch of a button. Previously, this was a futuristic vision; from today it is a reality. With function+, HOMAG is setting standards when it comes to flexibility: Machine functions can be activated in just a few clicks, without a service technician, in less than 48 hours. Another plus point: You only pay for functions when you really need them. And if you are unsure whether a function is beneficial, no problem. Just test it — completely free of charge and with no obligation.

The following features can be retrofitted as required on the SAWTEQ S-300/310 in just a few clicks using **function+***

- **intelliGuide Classic:** You can easily activate this function free of charge and without restrictions — **our gift to you for the introduction of function+** (page 15)
- **Cut-out and stress elimination cuts** (page 45)
- **MMR professional:** Records a large number of production data for you — for example, the number of workpieces produced or the operating time of your machine

- **Data backup to network drives:** Automatic backup of your machine data to your network drive saves you valuable production time

- **combiTec recut option,** if the motorized scoring saw stroke is installed (page 49)

MORE AT HOMAG.COM



function+

* Only available in tapio countries.

Apps and digital assistants.

Quick and easy support in your machine environment.

Some people still use pen and paper to create their cutting patterns. But they look at their smartphone if they want to know what the weather is like — instead of looking out of the window. We asked ourselves: why not combine the best of both? Our apps and digital solutions make your everyday work easier: machines, material, tools, cutting patterns, components — you always have everything in your pocket or on your desk.

EXCERPTS FROM YOUR FEEDBACK:

- Are there simple solutions that can eliminate various obstacles in my day-to-day work (e.g. when organizing materials or sorting parts)?
- Is there a way to slowly approach using digital assistants?
- Which tools can you try out simply and easily without having to invest huge sums of money straight away?

OUR ANSWER? SMART AND POWERFUL SOLUTIONS:

- ✓ Always low investment
- ✓ Always up to date (no updates necessary)
- ✓ Always easy to use (no complex software)
- ✓ Always helpful

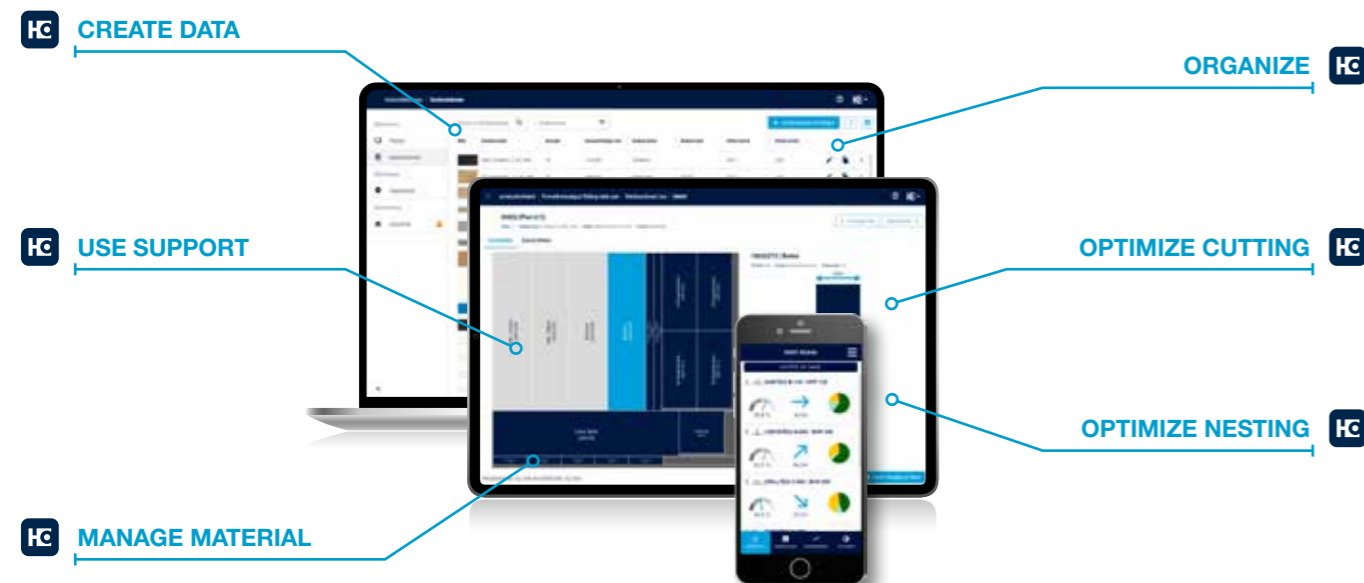

THE ADVANTAGES AT A GLANCE

- No investment, update or maintenance costs
Low starting price, no unplanned financial expense
- Licenses are independent of the user
Any number of employees can use the application without incurring additional costs
- Independent of hardware and operating system
Can be used anywhere, anytime
- Open system — import possible from almost all systems (ERP, industry software, CAD/CAM, Excel, CSV)
No obligation to use specific software systems
- Simple, smart operation
Minimal training required
- More efficient production
Jobs completed more quickly, more safely and in higher quality



More information at digital.homag.com



Optional feature: increasing productivity with the appropriate cutting optimization software

Production time, material yield, parts handling and logistics: efficient cutting with seamless processes requires intelligently optimized cutting patterns. For HOMAG saws, the appropriate optimization solution is available on demand — from large to small, as permanently installed software or directly from the tapio cloud. You have the choice because the SAWTEQ S-300 / S-310 is, like all HOMAG saws, tapio-ready.



intelliDivide — the easy way to achieve first-class optimization results

Simply upload the parts list. Done! The result? A choice of several alternatives for cutting patterns and entire runs. That's how easy intelliDivide makes it.

In detail: the cloud-based optimization software intelliDivide utilizes significantly higher computing capacities than are available for locally installed optimization software and can therefore swiftly provide the user with several alternative optimization results.

This means that with intelliDivide the operator can choose from a variety of options, including results based purely on reducing waste, on the shortest machine time or on the simplest handling, perfectly adapted to the relevant requirements.

Applications are varied and are geared toward both woodworking shops and industry.



Cut Rite cutting optimization software

Efficiency through planning: This short phrase sums up the key benefits of the Cut Rite software. With this world-leading software solution, you can optimize waste and systematically lower the overall costs for cutting.

Highlights

- Seamless, precise and highly efficient processes ensure optimized project control
- Efficient cutting processes which can be individually adapted to your production processes using parameter settings
- Full cost control within the cutting process: material costs and processing time are calculated automatically when the quotation is prepared
- Faster calculations by using all the processors in the PC
- Simple handling: clearly structured, easy to operate and graphic display

Find out more in the "Cut Rite" brochure.

intelliGuide — innovative smart operator guidance

The intelliGuide operator assistance system is made up of many different components. Each individual component improves the processes in your production. Together, they convert the saw into an intelligent system that reacts interactively to the operators and their actions, thus optimally guiding them through the processing cycle. It becomes more intelligent with each stage of expansion: from intelliGuide Classic to Advanced, right through to Premium. So you get precisely your solution.

NEW: Every new SAWTEQ S-300 / S-310 comes with intelliGuide Classic as standard. You can activate the assistance system easily via function+.



MORE AT HOMAG.COM



intelliGuide

The benefits of intelliGuide

- Quick and easy processes: operator and saw work in tandem and do not slow each other down
- The machine is intuitive to operate thanks to colored LED signals: The operator rarely has to look at the monitor, allowing them to concentrate fully on processing the cutting pattern
- Smooth, ergonomic and safe processes for efficient working
- Easy to change operator at any time



The foundation:

1. CADmatic 5

intelliGuide is the result of a long period of technical evolution. It all started with the CADmatic saw control system. It has a 3D assistance graphic that clearly shows the machine operator all the work steps in order and guides them through the cutting process in a simple, intuitive and ergonomic manner.

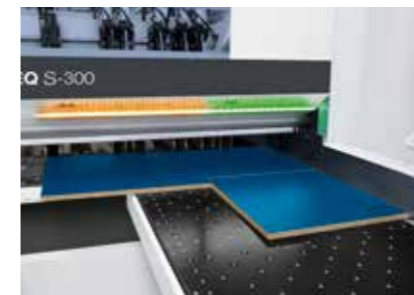

function+ ready

NEW in the standard features — intelliGuide Classic:

1. CADmatic 5

2. LED strip at the cutting line

- Colored LED signals at the cutting line allow intuitive operation and a quicker, safer way of working
- Using the colored LED elements, machine operators can immediately see if a part has been fully processed, needs to be cut again or needs to be disposed of as a waste part
- Based on the LEDs that are lit up, the operator can determine whether the workpiece being processed meets the required specifications

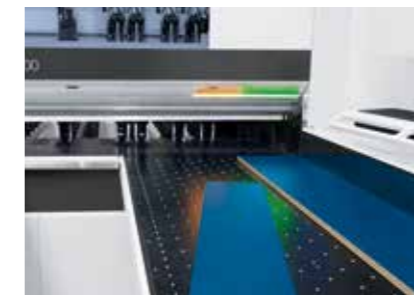

Optional feature — intelliGuide Advanced:

1. CADmatic 5

2. LED strip at the cutting line

3. Camera

- The camera delivers images from the front machine table and these are evaluated on an ongoing basis
- The saw therefore always knows which part or strip the operator is inserting and in which alignment
- This allows the saw to respond intelligently and flexibly to the actions of the operator

4. Illumination

- Enhances safety and quality by ensuring the workplace and workpieces are evenly lit
- Improves the appearance of the workplace and makes it even more ergonomic

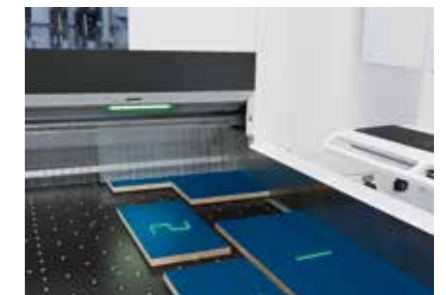

Optional feature — intelliGuide Premium:

1. CADmatic 5

2. LED strip at the cutting line

3. Camera

4. Illumination

5. Laser

- Projects clear information regarding processing and handling directly onto the current workpiece
- Arrows, for example, indicate the direction in which a panel needs to be turned and how it needs to be positioned. An X means that the wrong part has been inserted. The trash can icon indicates waste parts
- In short: Thanks to the self-explanatory symbols, operators always know which step they need to perform next and can immediately take the appropriate action

Destacking concept: for zero errors – even with mixed stacks

The destacking concept guides the operator from depositing the first part to forming the perfect stacked pallet. This has been achieved by combining software and hardware in an overall concept. The software shows machine operators when and where they should stack each particular part. You select the appropriate hardware components according to your requirements. Altogether, this adds up to improved efficiency and ergonomics for all work steps. Times and routes that do not add value are systematically reduced.

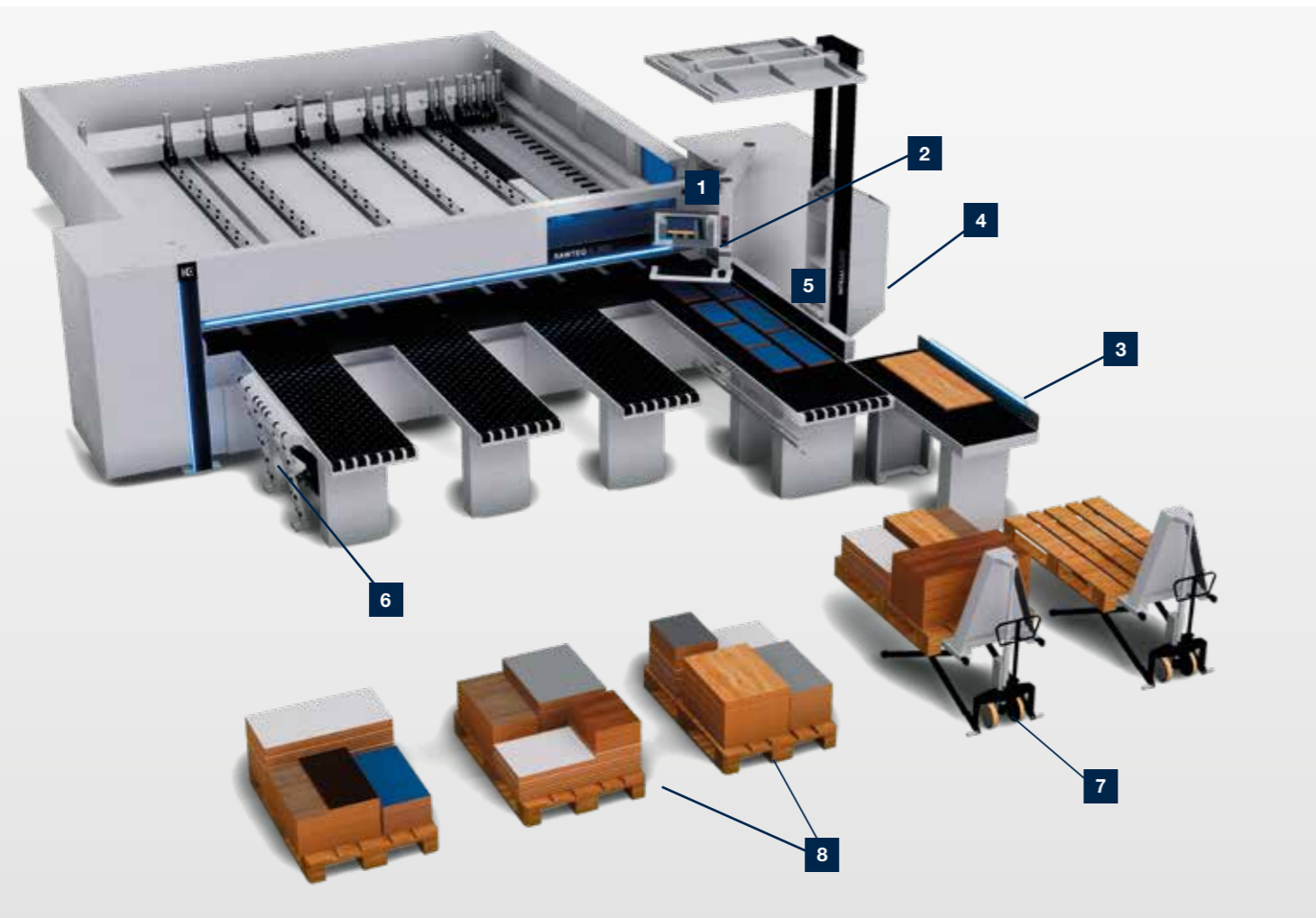

1 Destacking software as add-on module for CADmatic 5

2 Label printing with destacking details – using the manual label printer or the automatic label printer near the pressure beam (page 53)

3 Ergonomic parts buffer

4 Waste container

5 Chopping edge

6 Pneumatically operated feeding and destacking aid on the long side of the air cushion table

7 Scissor lift pallet truck "HuGo"

8 Intelligent stack formation

[MORE AT HOMAG.COM](https://www.homag.com)



Material in motion



CADmatic destacking module

Which part belongs where? The CADmatic destacking module answers this question by means of an integrated destacking graphic. This optional feature is available as part of the Classic and Advanced versions. In both versions, the single parts are color-coded in the cutting pattern and also in the assistance graphic. This means operators can see on the monitor exactly when they must place a particular part on a particular pallet.

Additional advantages with the Advanced destacking module: Operators are not only shown which part should be destacked onto which pallet, they also see exactly where a part is to be placed on the pallet.

This ensures intelligent, stable stack formation. Furthermore, the Advanced destacking module allows the program sequence and the destacking strategy to be controlled more delicately and appropriately. You can specify, for example, whether the stack formation is optimized for subsequent processing steps on the basis of the order or the material. These priorities can be combined with one another and weighted according to the primary objective.

This results in clear, highly efficient operator guidance with less walking between the saw and the destacking location, optimized pallet utilization and process-optimized, stable stack formation.



Parts buffer with swiveling label printer

The parts buffer with swiveling label printer ensures efficient processes and ergonomic handling.

- It indicates to the operator by LED display whether a part should be temporarily stored. This is particularly useful for forming stable stacks or to avoid slowing down the saw, for example.
- The swiveling label printer is located in a convenient position for the operator and dispenses the right label for each part at the right time.



Scissor lift pallet truck "HuGo"

The scissor lift pallet truck "HuGo" is equipped with automatic height control and facilitates ergonomic and intelligent destacking processes. A light barrier controls the automatic raising and lowering of the pallet truck, also allowing you to remove all the parts from the pallet at an ideal processing height — at an edge banding machine, for example.

[MORE AT HOMAG.COM](https://www.homag.com)



Pallet truck "HuGo"

Advantages

- The machine operator knows at all times which part is to be destacked and where. This reduces, among other things, distances to be covered and the time required
- Intelligent stack formation according to individual specifications
- Saves space, as demonstrably fewer pallets are required

SAWTEQ S-300

With the SAWTEQ S-300, you get a compact and powerful single saw that offers impressive versatility. It is ideal for connecting to an automatic HOMAG horizontal storage system, for example.



The highlights

- **NEW:** Swiveling multi-touch display with new operating position on the pressure beam
- 80 mm saw blade projection, 95 mm as an option
- Ergonomic table height of 920 mm
- Simple and intuitive handling



SAWTEQ S-310 with lifting table

This model sets you up for big jobs. The integrated lifting table for automatic feeding speeds up your production processes by a considerable margin, particularly if you frequently cut panels made from the same material or in books.



The highlights

- **NEW:** Swiveling multi-touch display with new operating position on the pressure beam
- 80 mm saw blade projection, 95 mm as an option
- Ergonomic table height of 920 mm
- High material throughput for cutting books and series



ecoPlus – because efficiency starts with the use of resources

Energy, time, material and personnel are all precious resources. Conserving them increases productivity and saves costs. The ecoPlus technologies from HOMAG help you to achieve this aim, providing countless innovations that save energy and reduce your operating costs. What's more, ecoPlus reduces CO₂ emissions and protects the environment. A worthwhile investment twice over.

ECOPLUS TECHNOLOGIES FOR MAXIMUM ENERGY SAVINGS

- The standby button, a standard feature, puts the saw in an energy-saving standby mode at the touch of a button
- SAWTEQ S-300 / S-310 with IE3 motors
- Variable speed control by means of a modern bypass circuit for all models with frequency-controlled main saw motor
- The geometry of the saw carriage enables highly efficient extraction
- All models are equipped with an energy monitor for monitoring consumption
- Less energy required thanks to optimized suction device
- Thin-cutting saw blades can be used on



request, ensuring reduced waste and providing other benefits

- Many innovations for improved ergonomics and seamless production processes

Standard features

Even in the standard version, SAWTEQ S-300 / S-310 offers the full range of standard features and can be put to flexible use, either as standalone machine, interlinked with other machines or as part of a production line, depending on the production concept. This makes SAWTEQ S-300 / S-310 the ideal solution for woodworking shops and industry in many applications.

Optimum performance is the result of numerous high-tech solutions

Speed, quality and precision during the cutting process can only be achieved if panel materials are moved quickly, gently and with a high level of accuracy. This is ensured by numerous technologies that interact smoothly with one another — from the program fence and pressure beam to the clamps and patented side pressure device.



Program fence for precision and dimensional accuracy

- Resistant to torsion and bending
- Electronically controlled
- Precision guidance on H-girder
- Electromagnetic measuring system guarantees a positioning accuracy of +/- 0.1 mm per meter
- Measuring system involves no wear and no maintenance

Rugged pressure beam for first-class cutting quality

- Large-area pressure zone directly at the cutting line reduces material vibrations to a minimum
- Toothed rack and pinion ensure the necessary parallel adjustment
- Linear guide on both sides for precise cuts, even in books
- Optional: with automatic height control

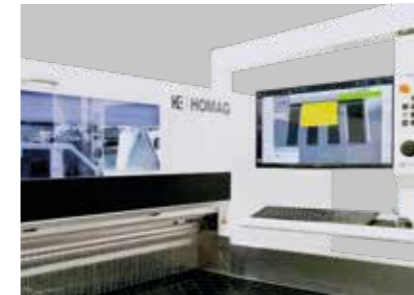

NEW: Multi-touch display that can be swiveled and tilted

Display with a new operating position on the pressure beam enables ideal orientation and a clear path for waste disposal. Operation together with IntelliGuide is particularly intuitive.

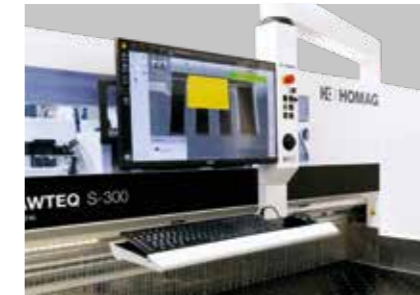

Clamps

- Robust clamps, all with two fingers
- Gentle positioning of material
- The bottom fingers of the clamps can be removed at any time to allow the back of the clamp to be cut in perfect alignment — a fast way to adjust
- The contact pressure can be adjusted (manually) to suit each particular material
- The short, rugged design allows material to be precisely held and guided more gently
- Irrespective of the book height, the top fingers of the clamps do not exert any leverage; instead, they are lowered horizontally and their entire contact surface rests on the material. This increases the working depth and ensures material is held firmly
- Designed for continuous, multi-shift operation



Patented: central side pressure device

- Integrated directly into the saw carriage — shortens cycle times by up to 25% in comparison with conventional systems
- Infinitely variable adjustment of contact pressure — depending on panel thickness. This allows even thin panels, laminates or sensitive materials to be processed perfectly. Another key feature here is the book-height-dependent control of the contact pressure: the higher the book, the greater the pressure



Chopping edge on the right-angled fence

With the help of the chopping edge, waste strips can be disposed of quickly and easily. The robust edge is within easy reach of the operator and ideally positioned on the right-angled fence, allowing waste to fall directly into the container for improved ergonomics.

MORE AT HOMAG.COM



Central side pressure device



Chopping edge

The saw carriage: high performance, low consumption

Exceptionally smooth running, high precision and low energy consumption are the hallmarks of the saw carriage developed especially for the SAWTEQ S-300 series.



One saw carriage, numerous benefits

- **NEW:** Optimized chip guide reduces suction power by up to 12%, saving you valuable energy and extending the tool life — especially with abrasive materials.
- Torsion-resistant, rugged and resilient basic design of the steel plate body for maximum dynamics and precision
- Infinitely variable feed speed — for precision cutting of demanding materials
- Long-term accuracy of saw blade projection
- Fast, precise, low-wear and infinitely variable positioning of the main saw blade by means of linear guide system with rocker arm (patent)
- Energy-saving feature: main saw motor is not raised
- Low-noise, maintenance-free main saw blade drive unit
- Spring-preloaded wheels always in perfect contact with the guides
- Light sensor with blower unit
- The design of the saw carriage ensures excellent extraction
- Postforming package, optional (page 48)



Tool change — easy, ergonomic, fast

- **NEW:** Power-Loc system with clever flange support for fast and easy saw blade changes
- **NEW:** Reduced maintenance time as well as less damage to the tool and material thanks to an easy, central and ergonomic access

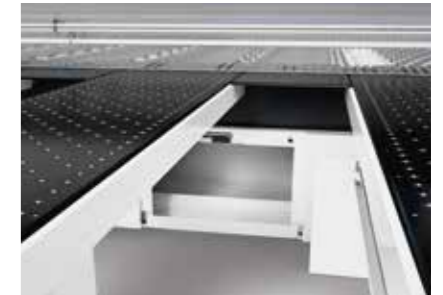

Handy cleaning flap

Quick and convenient: the area under the saw carriage is easily accessible via flaps, allowing easy removal or vacuuming of cutting waste.

MORE AT HOMAG.COM



Power-Loc



Cleaning flaps

The SAWTEQ S-310 with lifting table – more technology from the start

Panel dividing saws with integrated lifting table set themselves apart with their automatic feed system and increased level of automation. In short, these saws work differently from the SAWTEQ S-300 without lifting table and therefore require additional technical solutions even in their standard version.



Powerful feed system

- In the case of lifting table machines, panels are fed via an electro-hydraulic four-column lifting table
- Automatic determination of book height
- Equipped as standard with longitudinal profiles and sensing device
- Also suitable for thin materials from 9.5 mm upward. Suitable for materials from 3 mm upward if equipped with the optional micro feed and hold-back device (page 40)
- Maintenance-free and no lubrication required

Separate backing wall

The backing wall is not attached to the machine bed, ensuring precise cuts. This is because vibrations caused by the movement of stacks on the lifting table are not transferred to the machine bed.



Feed solutions and storage solutions ranging from S to XXL

Manually transporting panel material from the shelf to the saw is time-consuming and often not ergonomic. This is just one of the reasons why automation solutions from HOMAG pay off within a short time. Furthermore, they save a lot of space and are available for almost every size of company. The spectrum of solutions ranges from the basic feed system via the lifting table through to the large-scale storage control connection to the STORETEQ P-300 and P-500. What's more, all saws in the SAWTEQ S-300 series are also open for connection to virtually all storage systems. This ensures the very highest level of performance.



Optional features

More technology for customized production down to the very last detail: these features allow you to supplement the functionality of your saw in line with your requirements — from the storage control connection and performing the actual cutting process to labeling and destacking. So you get exactly your solution.

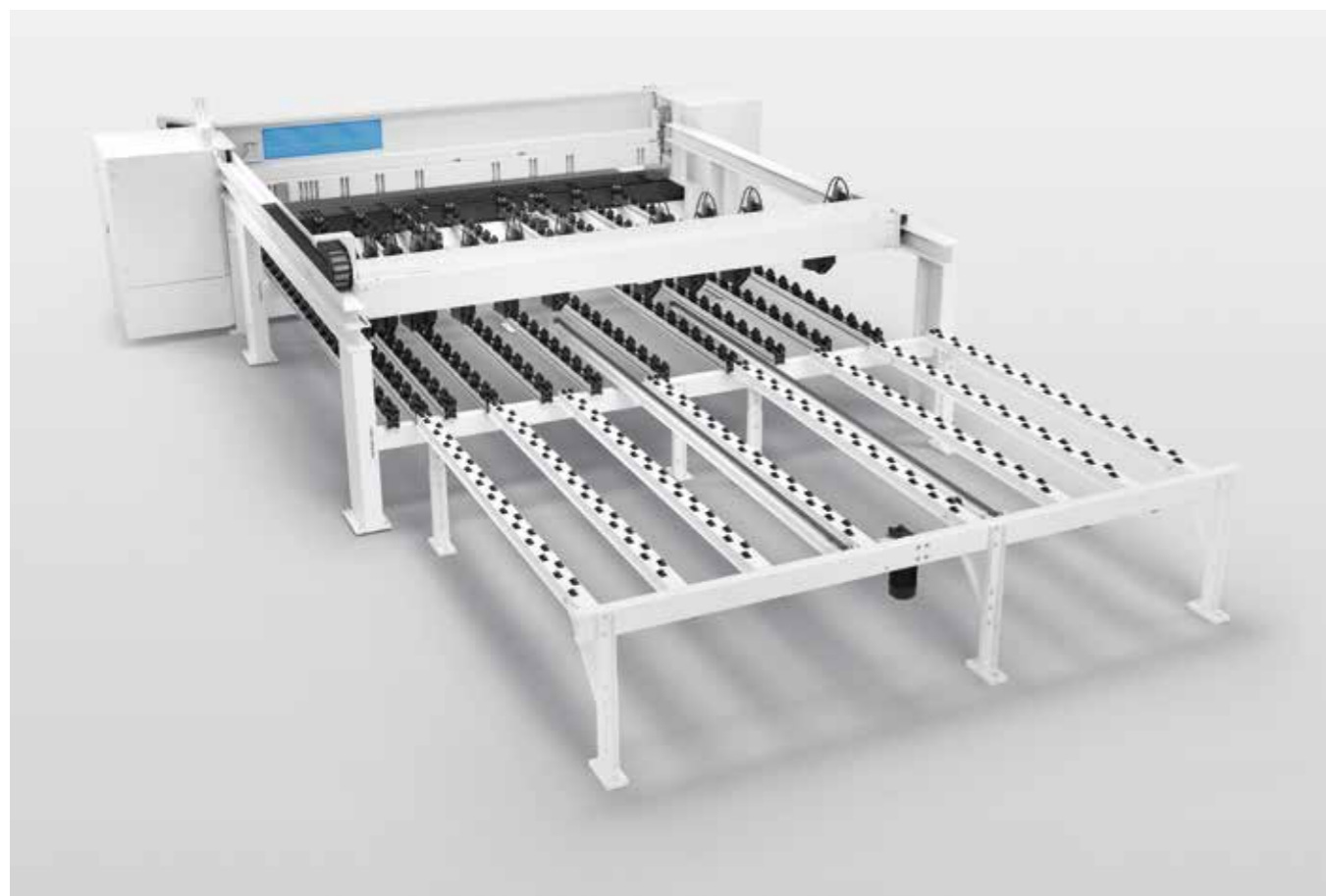

Feed-stacking table with integrated feed

When linked to a simple storage control connection, the saw has to stop working briefly when a new panel is fed. The feed-stacking table now ensures smooth, faster cycles: while one panel is still being cut, the storage system already positions the next panel(s) on the feed-stacking table with integrated feed.

- Ideal in combination with the HOMAG panel labeling system (page 53)
- Can be retrofitted at any time
- Plug & Play: easy add-on
- Perfectly matched to the saw (height, width, roller rails)
- No more waiting times



Greater visibility while maintaining safety (for single saws without lifting table only)

While angular saw units and saws with lifting table come as standard with an all-round protective fence, saws without lifting table have a protective guard around the rear machine table. The sides of this protective guard are made up of individual elements which can be equipped with windows if desired — one is already included as standard. Further windows can be added as needed. This ensures greater visibility while maintaining safety levels.

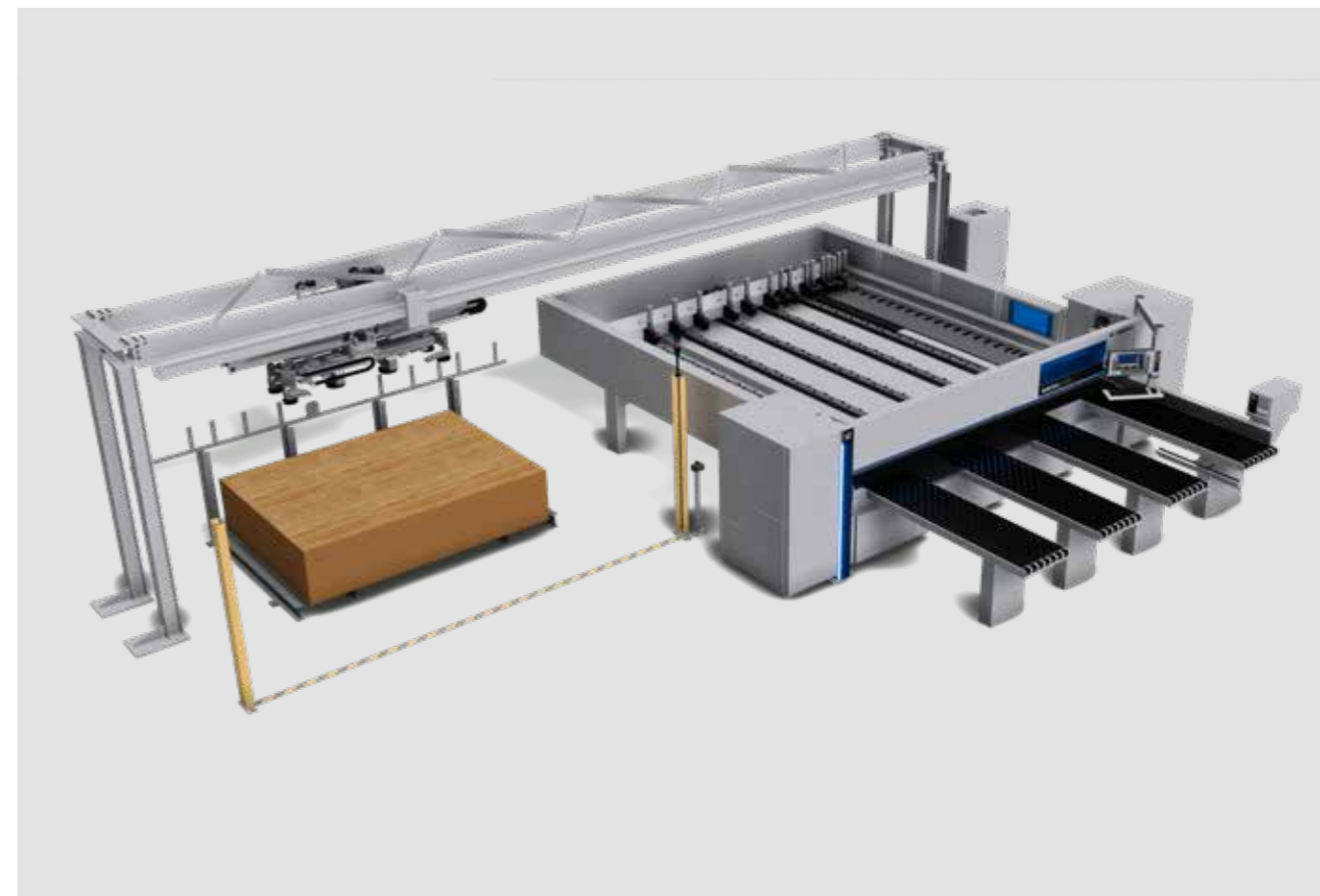

HOMAG STORETEQ F-100 single-axis feeder: fully automatic and gentle on material (only for single saws without lifting table)

Efficient, ergonomic, material-friendly: The new HOMAG STORETEQ F-100 single-axis feeder is an asset to every aspect of the production line and it does not take up much space either. Control directly at the saw via woodStore is particularly intuitive and simple. In conjunction with the SAWTEQ S-300, this creates a complete woodworking shop cell — including offcut management. Using vacuum suction units, the gantry fetches the next panel required from the stacking position adjacent to or behind the saw, turns the material if needed, and then places it in the saw, all on a just-in-time basis. All fully automatically.

Your benefits at a glance:

- **Speed up your feed:** The integrated complete solution leads to significantly higher saw performance. Additional benefit: Less time for sawing means more time for other value-adding activities.
- **Fully automatic panel handling:** A continuous process increases your productivity and saves time.
- **Optimized transport:** The single-axis feeder secures your panel quality.
- **Fits into any workshop:** The space-optimized feeder requires hardly any installation space.
- **More ergonomic:** The automatic feed makes work easier.
- **Standard interface:** All machines are already configured and ready for use — without any additional service support.
- **Intuitive operation:** You can operate the feeder conveniently via woodStore directly at the saw.

Standard features

- Basic frame in gantry design
- Movable lifting device with suction crossbeam
- Turning unit – rotatable up to 90 degrees
- Automatic weight detection
- Automatic length adjustment of the suction crosshead

Optional features

- Stacking positions available in 3,200 mm or 4,200 mm board length
- Additional storage places possible
- Expandable up to 8 stations, of which
 - maximum 3 processing machines
 - maximum 4 storage places
- Additional control panel for several integrated machines

Growing together. The all-in-one solution for your panel storage.

Whether it's a wide range of parts, high speeds or full equipment: the new storage range combines the strengths of automation with intelligent logistics. To provide an optimum storage control connection, we have expanded the design of the storage platform for the STORETEQ P-300 and P-500 storage to include a second-level STORETEQ P-310 and P-510 storage system and a STORETEQ P-320 and P-520 double-level storage system. The storage systems represent intelligent logistics with noticeable optimization effects — above all in the greater reliability, availability and standardized data integration and processing. This is achieved through the consistent use of the leading woodStore storage software.

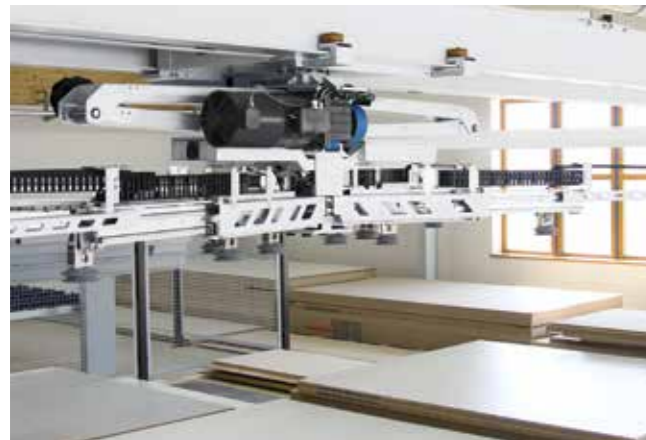

The **ST71 suction cross rail** in X geometry is the ideal optional feature for the panel storage. The self-learning cross rail generates the data required for panel handling independently and thus ensures dependable process reliability. The operator does not have to enter anything.

The HOMAG storage systems optimize your storage area and save valuable production space

- One software, all options: the woodStore storage software grows with your requirements
- No compromise: configure the solution that best suits you
- Intelligent standby — the machine only uses energy when it is actually moving
- Optimal material consumption right down to offcuts thanks to well-thought out material management
- Handling without any extra costs — coated panels from a thickness of 3 mm thanks to the ST 61 suction traverse, which is already included in the standard version
- Perfectly coordinated: ideal use of the given space — without expensive hall extensions
- Complete solution from a single source — including saw, nesting machine, storage platform and software



Great variety of materials

Whether it's handling plastic, plexiglass or laminate, coated or uncoated panels, the storage is also a true all-rounder when it comes to handling panels.

- Panel weights up to **350 kg** and panel lengths up to **5600 mm**
- Smooth transport of even textured surfaces
- High double scissor stability for precise panel handling
- Handling of plastic panels



STORETEQ P-500/P-510/P-520 — flexibility and variety of materials combined in one storage system

The sturdy construction of the STORETEQ P-500/P-510/P-520 allows a great deal of flexibility when designing the system's length and width.

- Span widths of up to **16 m** and travel path lengths of up to **100 m**
- Controlled, low-vibration movements even in the largest version



Ten important reasons to opt for the woodStore storage control system

1. Open database system enables seamless integration
2. Multi Terminal offers transparency and ergonomic operation
3. Smart Connected System: optimization, processing machine and storage are fully integrated into one cutting system
4. intelliStore: flexible storage organization that automatically adjusts to production conditions
5. Complete offcuts management prevents the buildup of offcuts
6. Forklift operator management: enables material supply separate from cutting
7. Management of outside storage is integrated
8. Easy Edit production lists: easy to change orders and sequence
9. Various storage strategies enable easy adjustment to production scenarios
10. Optimization of the production sequence enables high performance

woodStore 8. Portable, networked, user-friendly.



Mobile operation

Various functions can be controlled via mobile end devices connected within the machine's WIFI network.



User management

Personnel-controlled storage operation with a functional range of up to 40 different user rights.



Smart Connected System

Complete integration of optimization, saw and storage into one cutting system with corresponding standardized interfaces.



Email notification

In the event of any malfunctions in the operation of the storage system, the system sends an email to the email account specified.



Database access analysis

Customer database is measured for performance and logged to identify digital bottlenecks.



Smart Separation Learning

Fully automatic panel separation that requires only two panel handling settings.



intelliStore

All storage movements are monitored permanently and automatically adjusted to the current production conditions.



Integrated image database

Easy selection and assignment of panel finishes for realistic representation of the panels available in the storage.



Scrap management

Automatic return of saw offcuts to storage with built-in panel measurement as part of the material intake process and management of manual offcut stocks with corresponding wizards for easy set-up.



woodStore Analyzer

In a period that can be selected individually, the main functions of the storage system are examined and analyzed according to the customer's requirements in order to determine whether the customer is using the storage system optimally.



Intelligent logistics are a key to success

HOMAG storage systems are intelligent all-rounders that meet all your needs. From the smallest storage "that would fit into a double garage" to the multi-story storage that would meet industrial requirements. Across all levels of production, the flow of material is optimized, stocks are managed transparently and processing machines are used in an optimal way.

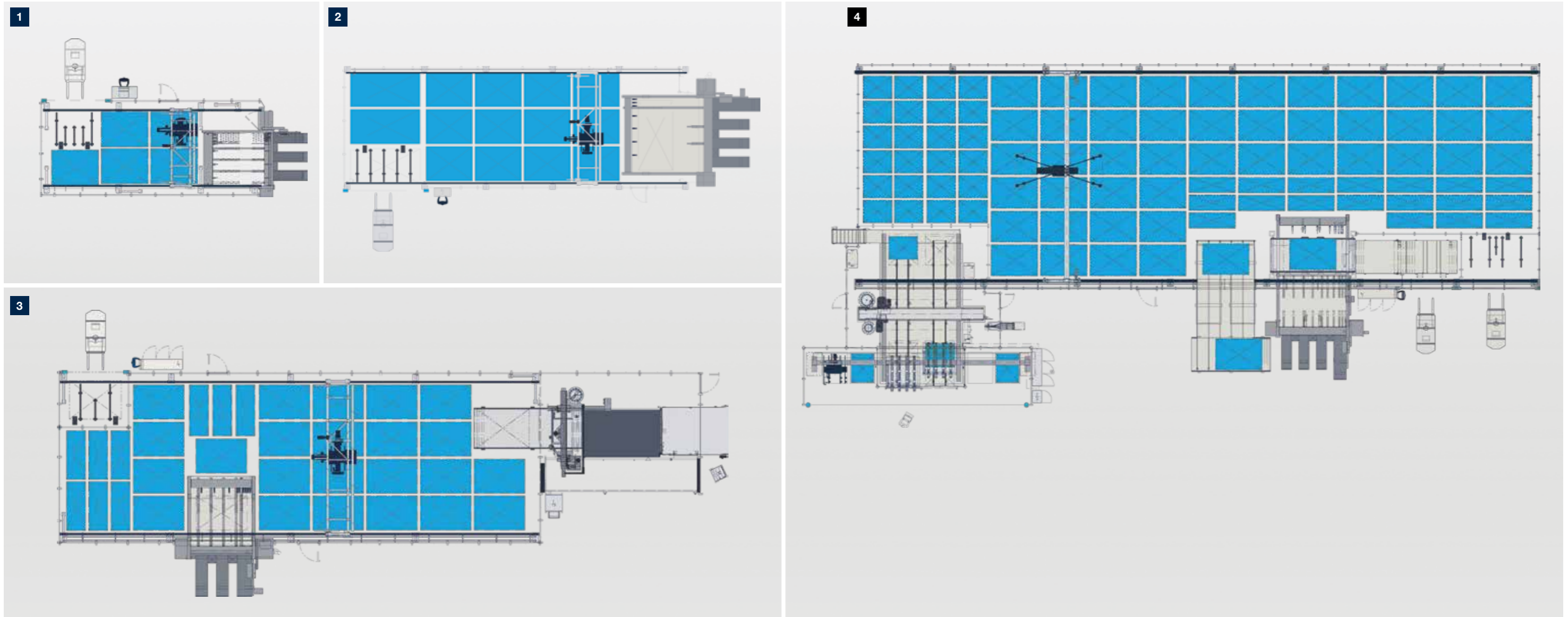

1 Storage and saw with 5 stacking positions

Users include those working in traditional joinery

2 Storage and saw with 14 stacking positions

Users include fitters

3 Storage with saw and CNC processing with more than 20 stacking positions

Users include those working in trade fair and shop construction, suppliers

3 Storage with saw and processing center with more than 30 stacking positions

Users include kitchen and furniture manufacturers working on an industrial scale

Extra tools for demanding materials

Exceptional materials require exceptional technical solutions. These are available in abundance for the SAWTEQ S-310 with lifting table — for thin panels, for example.

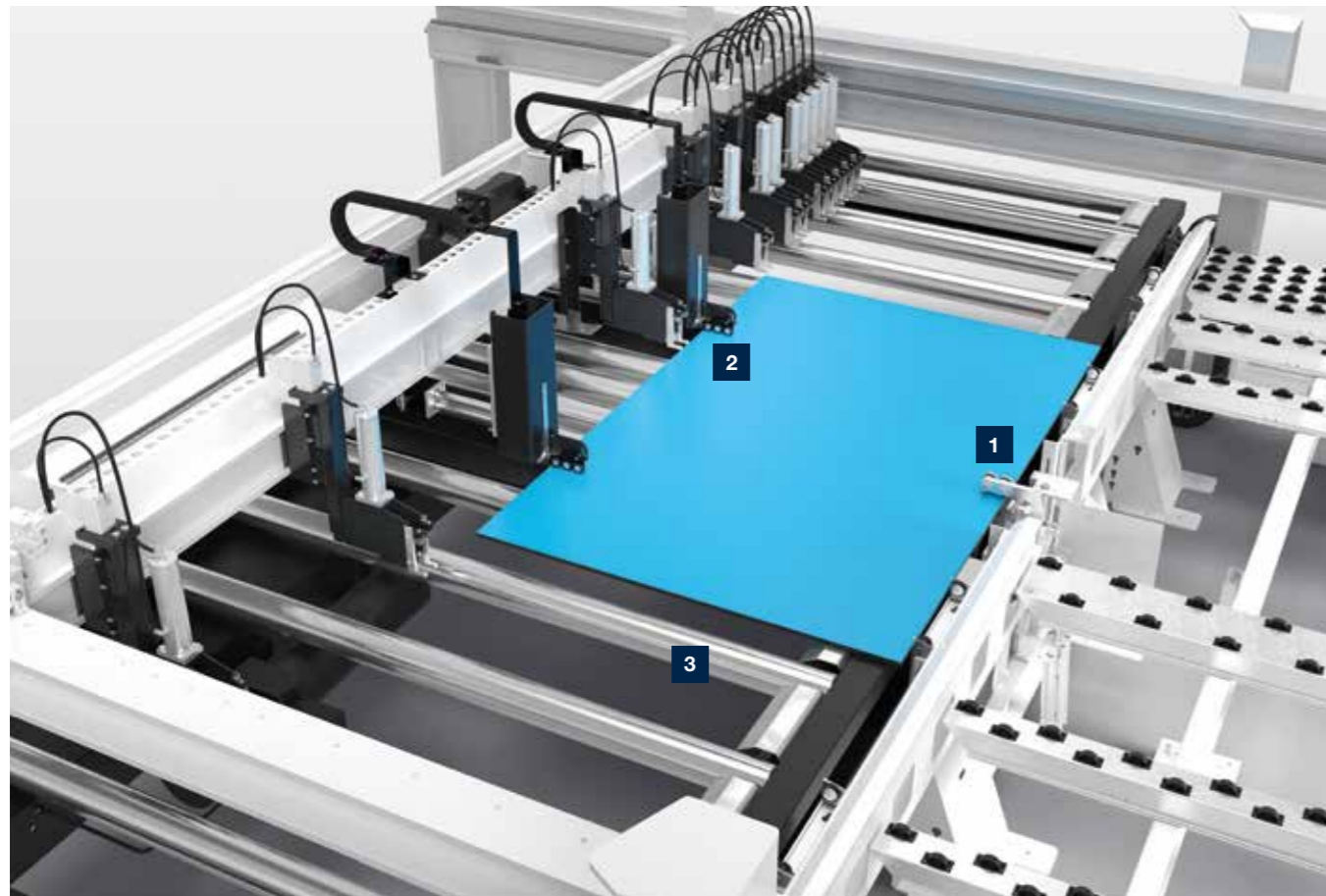

1 Hold-back device for thin boards

For thin panels from a thickness of 3 mm.

2 Micro feed for thin panels

The micro feed option allows thin panels from 6 mm upward to be pushed onto the rear machine table (provided that their properties meet HOMAG specifications). Book height is measured by a non-contact, electromagnetic measuring system which is completely maintenance-free.

3 Extra impetus for the feed

The automatically driven roller conveyor integrated into the lifting table and additional roller conveyors on the side ensure fast stack changeover.

[MORE AT HOMAG.COM](https://www.homag.com)



Micro feed

Small detail, big impact

It is often the smallest details that make the difference. After all, when these details come together, they can have a noticeable impact on the speed and ease of the production process.



Automatic ejection guide

Pushes panel offcuts from the rear machine table across the cutting line to the front and thereby ensures ergonomic and safe working.

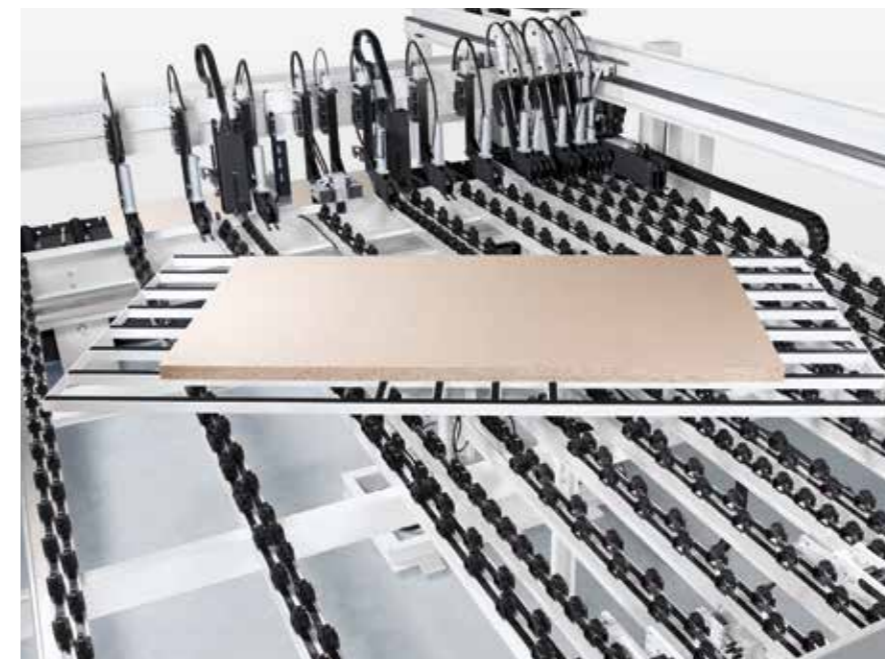

[MORE AT HOMAG.COM](https://www.homag.com)



Turning device

Turning device for headcuts

- The process is perfectly integrated into the machine cycle, ensuring shorter preparation times and a significant increase in performance.
- Labor-saving device for operators
- With automatic alignment function

Power Concept speeds up production

At the heart of this technology is a clamp that can be moved separately. Using this clamp, several strips with different cross cut divisions can be cut to length together, significantly increasing material throughput.



Power Concept Premium:

- Additional clamp that operates independently
- Clamps on the program fence that can be raised out of the overlapping work area as needed
- Simultaneous processing of two strips of different lengths
- Precision cutting — even of very narrow strips
- An algorithm adapted to the Power Concept Premium sorts the strips directly at the saw. This is based on existing optimization data for the shortest machining times

The Power Concept Premium clamp positions the last strip at the cutting line while the program fence fetches the next panel or the next book of panels from the lifting table. Good to know: to ensure your machine operators can master the considerably faster pace of production with ease, we recommend combining the system with the HOMAG destacking concept (page 16) or with IntelliGuide (page 14).

POWER CONCEPT



Lower costs per cut



Significantly improved material flow



High material throughput to easily handle peaks in production



Power Concept Advanced (for saws without lifting table)

This is the low-cost version of the successful Power Concept Premium — designed for panel dividing saws with feed from the front and for saws with simple storage control connection without integrated feed-stacking table. Power Concept Advanced can do everything that constitutes Power Concept, but can be integrated far more easily and consequently more economically.

NEW: Speed packages

With our two speed packages (1) with Power Concept and (2) without Power Concept, you can now produce even more quickly and avoid waiting times. The only prerequisite is feeding directly from the HOMAG storage.

(1) The Power Concept cuts the last strip, while the program fence is already positioning the next panel as far as it will go. In addition, the alignment without an alignment device (on the fly) shortens cycle times even further.

(2) Faster movement of the program fence over 25 m/min and alignment without an alignment device (on the fly) shortens cycle times.

MORE AT HOMAG.COM



Power Concept
Premium

Smart functions for special challenges

Not only precise, but efficient. Under this banner, HOMAG offers countless optional features for particular cutting tasks. Simply select your solution.

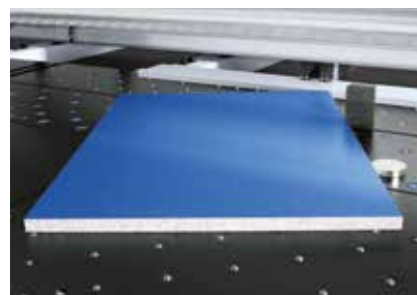

Manual angle cut

The angle cut device allows you to control angle cuts using the CADmatic control software.

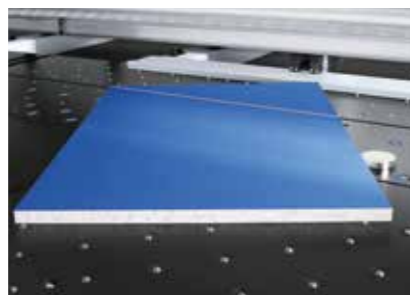

Automatic angle cut device

This technology completes angle cuts fully automatically, after you have entered the respective data in the CADmatic control system.

[MORE AT HOMAG.COM](https://www.homag.com)



Manual angle cut

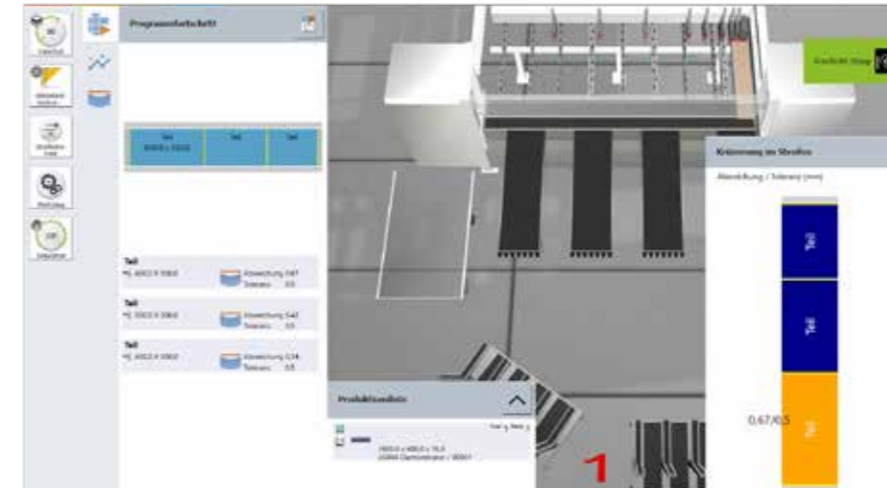

NEW: Integrated toleranceCheck tolerance measurement for high-precision cutting

With the innovative toleranceCheck, you can continuously ensure the individually required dimensional and angular accuracy — even for stress-prone material. In addition, it reliably detects insertion inaccuracies and informs the operator of these. This creates unprecedented transparency over the panel quality. In addition, the process reliability of the subsequent processing steps is increased by integrated quality assurance. The integrated tolerance measurement thus increases quality and productivity. Good to know: toleranceCheck together with the stress elimination cut becomes an attractive quality package.



Grooving and turbo grooving

These options save you an entire work step in post-processing. This is because your saw will also groove the panel material. The turbo grooving option even completes the grooves much faster than a processing center.

[MORE AT HOMAG.COM](https://www.homag.com)



Grooving



function+ ready

Cut-out and stress elimination cut

Stresses in the material are released when the material is cut and can influence the quality of dimensions and cuts. The stress elimination cut provides a solution here. Systematic preliminary cuts can be defined during optimization and release the tension in the material. The additional cut-out feature allows you to produce both cut-outs and intermittent grooves in panels, as required for kitchen sinks or doors, for example.



Cut-out function

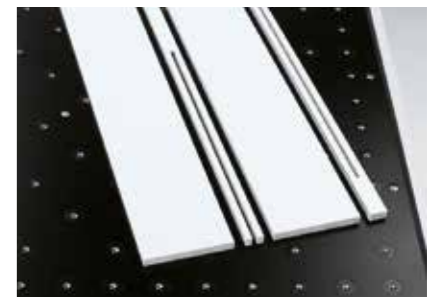

Stress elimination cut

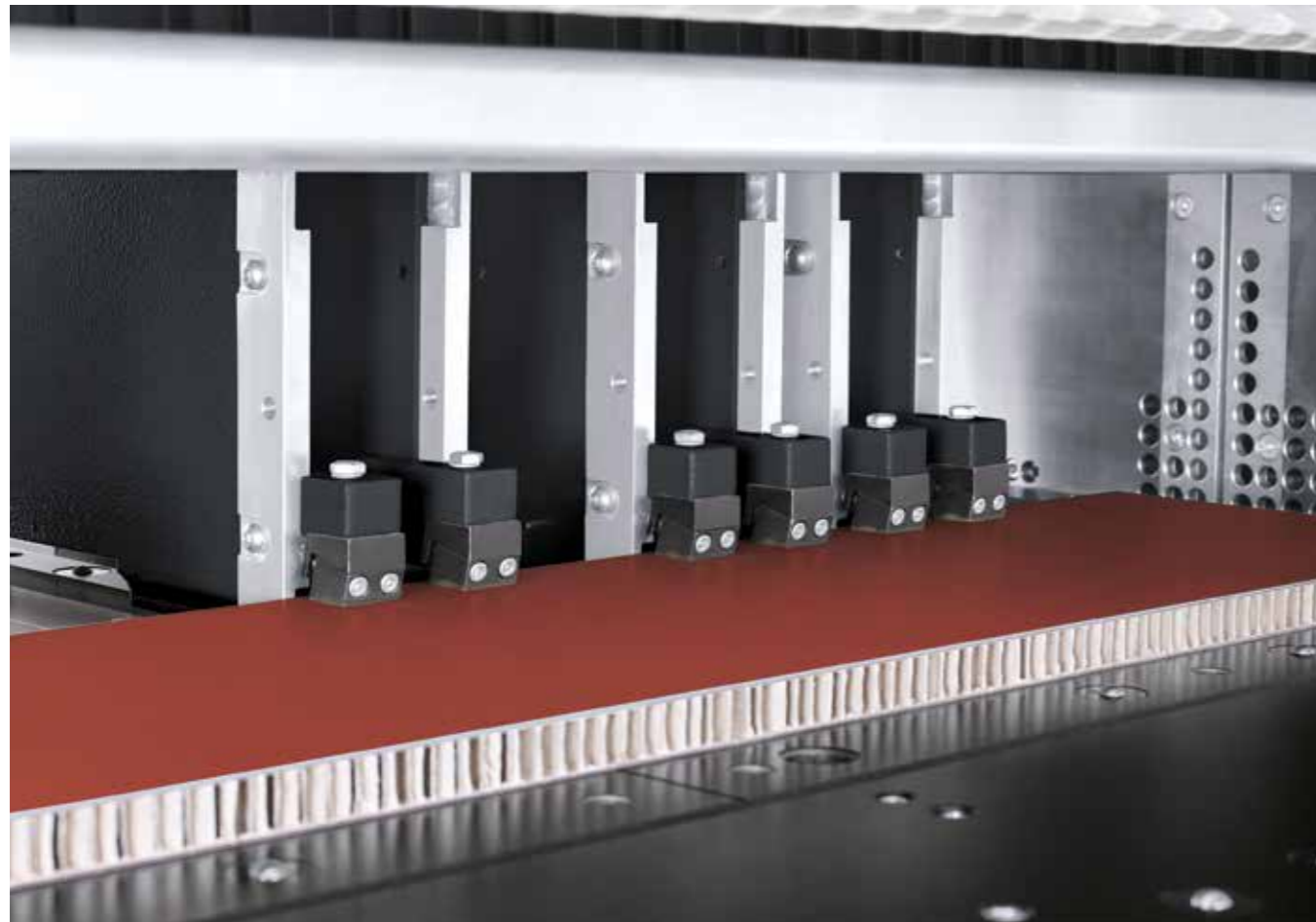

Soft Touch for pressure-sensitive material

As the diversity of materials increases, so do the requirements: pressure-sensitive lightweight boards, composite boards and plastic sheets are steadily gaining in importance. HOMAG has a range of solutions in its portfolio designed to meet these requirements. Simply ask your customer advisor.



High-precision laser guide beam

- Especially for solid wood, veneered panels and other materials with grain structure
- Pinpoint positioning right down the line

MORE AT HOMAG.COM



Laser guide beam



Pneumatically operated trim stops

The trim stops are attached to the clamps and are activated as needed by the CADmatic machine control unit.

- Adjustable to common panel thicknesses
- Gentle handling of sensitive materials with overhanging covering layers
- Precise positioning and adjustable to common panel thicknesses



Pneumatically operated trim stops

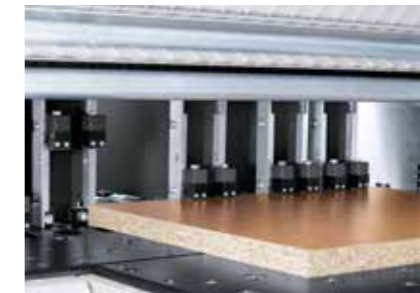

Clamp activation

This option prevents damage to edges. Now also available: clamp activation in "measuring" mode.



Program-activated clamps



Cutting gap closers

Open and close automatically straight after cutting, which prevents narrow strips or trims from becoming caught in the cutting line. They also ensure that the system is readily available.

Each cutting gap closer is individually controlled and monitored to achieve greater reliability (high-level availability)



Cutting gap closers

Extra-long cutting lengths
SAWTEQ S-300 / S-310 is also available with a 5600 mm cutting length as a further option.

Additional clamps

- For an even better grip on thin, narrow or smooth materials
- For increased material throughput

The perfect postforming cut

This optional feature is available in two versions. Both include a scoring saw raised by a motor, complete with automatic adjustment.



Version 1: ascending postforming

- Vertical-rise scoring saw (VRSS)
- Ensures perfect cuts on soft-formed and post-formed parts
- Maximum saw blade projection: 55 mm



MORE AT HOMAG.COM



Postforming

Version 2: ascending and vertical postforming

- VrSS as described in version 1
- Additional vertical scoring saw (VSS) with a maximum saw blade projection of 90 mm
- Scores the edge of the entire book (score depth up to a maximum of 15 mm)
- Ideal for edges covered with veneer, paper, ABS, etc.

combiTec performs recuts during the cutting process

Efficiency means saving time, material and costs — just like combiTec. The innovative recut function is ideal for all businesses that work in small production batches or even produce in batch size 1.



function+ ready

combiTec speeds up batch size 1 production

The combiTec recut function is now available for SAWTEQ S-300 / S-310 saws and optimizes batch size 1 production. This innovation completes all recuts fully automatically during the regular cutting process. Even complex cutting patterns can be generated and flexibly implemented. That saves time and material, thus reducing costs.

MORE AT HOMAG.COM



combiTec for single saws

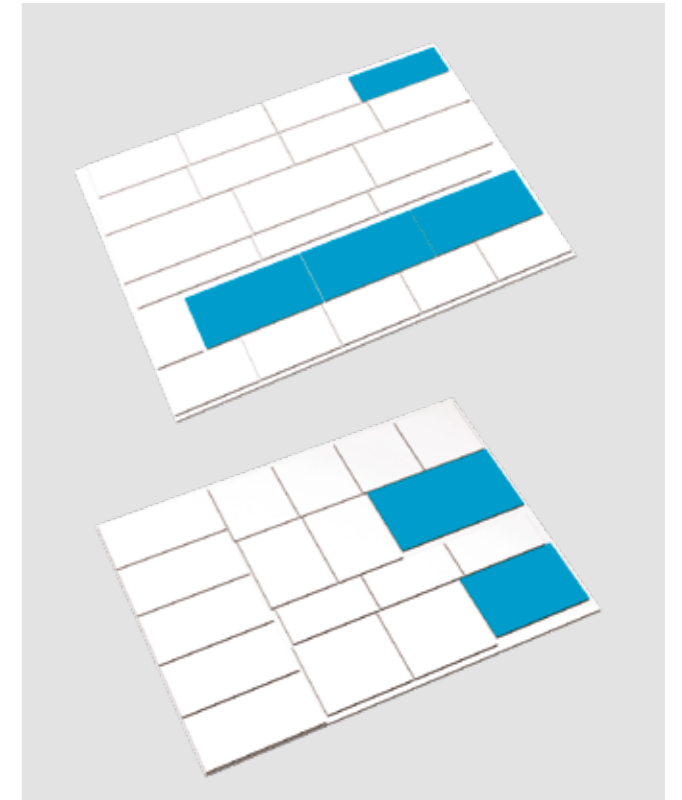

The benefits:

- Reduced material costs due to less waste
- No manual post-processing
- High speed
- Low unit and tool costs
- Excellent price/performance ratio

Air cushions for ergonomic operation

How can your machine operators handle heavy or excessively long parts with ease, even those that are susceptible to scratches? With innovative, tailored machine tables and air cushion tables from HOMAG of course. The choice is yours.



Movable air cushion table

The air cushion table is easily moved along linear guides and offers you a mobile work surface and storage area. It allows you to move small panels, large panels or books of panels more ergonomically and with less risk of damage.

Fold-down air cushion table

- Prevents thin materials from sagging
- Increases the work surface
- Primarily for large panels
- Folds down for easy access to the cutting line

Extended air cushion tables (not shown)

- Extended from 2160 mm to 2810 mm
- Greater freedom of movement
- Better connection to destacking systems
- Very useful when cutting large-format panels

Wider table elements

Air cushion tables are optionally available in a width of 800 mm instead of 650 mm. Just one, two, three or all four — whatever is best for your production.

[MORE AT HOMAG.COM](https://www.homag.com)



Air cushion tables

dustEx: making dust a thing of the past!

The more dust and chips that can be taken away by the extraction system, the better. After all, dust and chips can cause scratches on sensitive surfaces.



Patented dustEx technology

dustEx guides dust and chips on a direct route toward the dust extraction system. How does it work? Using combination air jets and an optimized extraction geometry at the right-angled fence. To complete the dustEx package, we recommend using a dust-trap curtain on either side of the pressure beam.

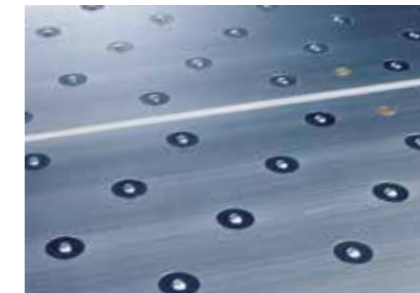

Anodized aluminum machine bed plates

The special coating ensures exceptionally gentle material handling. Ideal for materials with highly sensitive surfaces.

Dust-trap curtain on both sides

- Attached to the front and rear of the pressure beam. Dust-trap curtain only at the rear when combined with the labeler at the pressure beam
- Protects operators from dust
- Improves dust extraction
- Ideal for dust cuts

Designer lighting package (not shown)

Comprising:

- LED illumination of the cutting line
- LED illumination of the saw blade change area
- LED illumination in the switch cabinet

The benefit: simple, ergonomic working practices that protect the eyes.

[MORE AT HOMAG.COM](https://www.homag.com)



dustEx

Custom part designation

Whether generated automatically or manually on demand: with labeling solutions from HOMAG, you can clearly label each individual part and ensure parts can be identified at subsequent processing stations.



Label printer for superb results

The label printer from HOMAG allows you to print customized labels directly at the saw and design them to include bar codes, text and graphics if required. If you also use our Cut Rite optimization software, the material goes directly to the next process step with printed instructions. In this way, you can integrate the saw perfectly into your production flow.



Swiveling label printer

The label printer can also be swiveled horizontally to ensure ergonomic working practices. Available in combination with the parts buffer (page 17).



Panel labeling system

The innovation for saws with automatic storage control connection: the HOMAG panel labeling system labels the unprocessed panel before it is cut — independently of the saw, in non-productive time that previously went unused. It can also be combined with the feed-stacking table with integrated feed (page 40).

- Smallest part size 170 x 170 mm
- Up to 10 labels/min, optionally up to 15 labels/min
- Labeling independent of cutting process
- Saves time, because non-productive time is used productively
- Optimizes handling during destacking because all the parts are already labeled
- Simplifies and speeds up production processes
- Automated parts tracking
- Can be retrofitted
- For smooth processes



Fully automatic labeling

The labeler is located near the pressure beam, i.e. in your field of vision, and labels the finished parts/books even when several strips are processed simultaneously side by side (Power Concept). It makes no difference whether you feed the panels from the front or the rear. If desired, the position of the label can be individually controlled.

- Guides the operator through precise information on the destacking position or further processing
- Gives precise instructions for further processing
- Saves time

MORE AT HOMAG.COM



Manual labeling



Panel labeling system



Fully automatic labeling

module45 — giving your saw the scope to produce bevel cuts

With module45, you can now produce all cuts, including bevels, using just one saw. Work efficiently and flexibly without changing station, at infinitely variable angles ranging from 0 to 46 degrees.



The technology

- module45 consists of a stationary saw carriage with a swiveling saw blade that enables infinitely variable adjustment from angles of 0 to 46 degrees
- When viewed from the front, the unit is integrated into the air cushion table on the far left
- The table plate can be opened, allowing easy access to the saw carriage for changing saw blades
- Other features include dedicated contact pressure and suction systems, plus a fold-down right-angled fence for maximum operating flexibility at the front of the saw

Incorporate bevels into cutting patterns

Now you can also incorporate bevel cuts into your cutting patterns, either using the Cut Rite optimization software when preparing work in the office, or when inputting the patterns directly in CADmatic. Parts to be processed with module45 are then cut (oversize) and the operator only needs to set the angle of the bevel on module45 and start the cut.

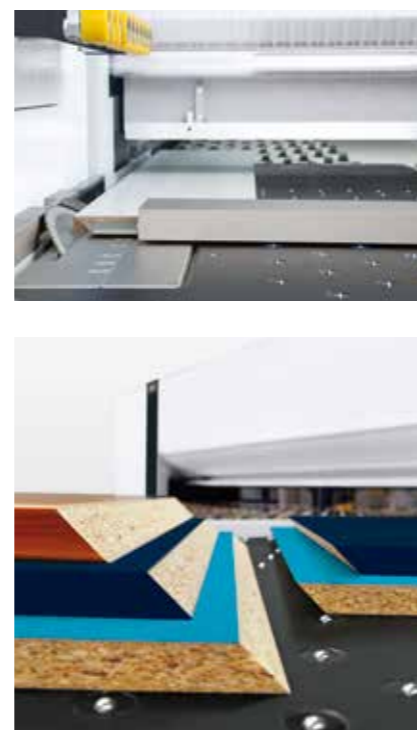

The benefits of module45

- You no longer need a sliding table saw for bevel cuts
- Higher energy efficiency as two machines have been combined into one
- Easy one-man operation
- Less waste and higher quality thanks to less transport damage as the material remains on the one machine
- Improved ergonomics and safety compared to circular saws
- Retrofit possible at any time on request

MORE AT HOMAG.COM



module45

Extras for improved efficiency, control and quality

Do you want to produce even more efficiently and monitor production processes with greater ease? You will find the right technology solutions for your cutting application here.



materialManager Advanced — the advantages at a glance:

- Efficient and simple machine use: Based on your quality requirements and saw blades, your machine automatically adjusts itself correctly to the material – regardless of the respective machine operator.
- Increases performance and ensures quality: Based on the material, predefined machine settings from HOMAG ensure an optimal interaction of feed and saw blade projection, as well as speed where applicable.
- Fewer sources of error: Automatic adjustment of saw parameters when the material is changed. The machine operator is also warned if they are using an unsuitable tool.
- Creates transparency: By looking at the app, the user can easily see how the tool was used and when it needs to be sharpened.
- Up to 8% performance potential: Optimized feed speed at a defined processing quality.
- Up to 20% lower tool costs: Extended tool life thanks to optimal saw parameters.

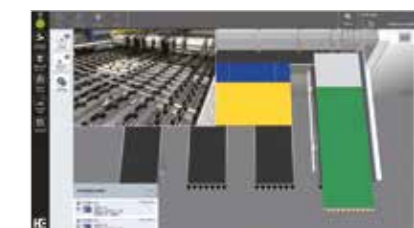

Everything in view — with video monitoring

- Display of the camera image via the CADmatic control software
- You always have the rear machine table and feed system in view
- Camera pictures can be recorded on request to diagnose errors and for workflow optimization purposes and can be sent to the HOMAG Service department



Additional start-stop key

- Allows the program sequence to be started independently of the operator control panel
- Equipped with an emergency stop key

SAWTEQ S-300 / S-310		
Model	S-300	S-310 with lifting table
Saw blade projection (mm)	80 (optional: 95)	80 (optional: 95)
Cutting length/width (mm)	3200/3800/4300/5600*****	3200/3800/4300/5600*****
Lifting table width (mm)		2200
Program fence speed (m/min)	up to 90 **	up to 90 **
Saw carriage speed (m/min)	up to 150 (optional: 170)	up to 150 (optional: 170)
Main saw motor (kW)	50 Hz: 11 (optional: 18 or 24) 60 Hz: 11 (optional: 21 or 28)	50 Hz: 11 (optional: 18 or 24) 60 Hz: 11 (optional: 21 or 28)
Scoring saw motor (kW)	1.5 (optional: 2.2)	1.5 (optional: 2.2)
Average total air requirement (NI/min)	140	200
Required compressed air supply (bar)	6	6
Extraction system (m ³ /h)	3350 (4790****), 26 m/sec	3350 (4790****), 26 m/sec
Max. stack height without pit (mm)	–	560 (up to 4300 cutting length) 450 (up to 5600 cutting length)
Max. stack weight (t)	–	4 (for 5600 mm cutting length: 7)
Processing height (mm)	920	920
Air cushion tables (mm)	3/3/4/5 x 2160	3/3/4/5 x 2160

* Values relate to the standard features

** Forward 25 m/min

*** Dim. A: incl. 64 mm for suction stubs. Dim. C: standard program fence width. There are wider dimensions for the lifting table.

**** For the 5600 mm cutting length

***** Only available in right-oriented version

***** Maximum contact width

Technical data and photographs are not binding in every detail. We reserve the right to make changes in the course of further development.

STORETEQ P-300/P-500 STORAGE		
	Basic machine	With optional extras
Span width (mm) P-300	5000	12000
Span width (mm) P-500	5000	16000
Frame length (mm) P-300	10000	50000
Frame length (mm) P-500	10000	100000
Speed		
Bridge (m/min.)	60	120
Carriage (m/min.)	80	120
Lift drive (m/min.)	30	45 without double scissor lift mechanism 65 with double scissor lift mechanism
Workpiece length (mm)	2000 – 4200	max. 5600
Workpiece width (mm)	800 – 2200	min. 400
Workpiece thickness, raw panels (mm)	6 and higher	
Workpiece thickness, MDF (mm)	3 and higher	
Workpiece thickness, coated panels (mm)	0,8 and higher	
Workpiece weight (kg)	250	350
Stack height (mm)	2100	2500

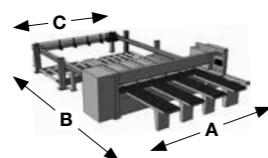
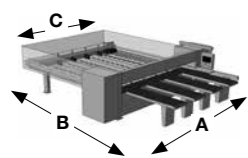

MACHINE DIMENSIONS***			
S-300	A (mm)	B (mm)	C (mm)
S-300/32/32	5364	6562	3660
S-300/38/32	5924	6562	4220
S-300/38/38	5924	7112	4220
S-300/43/32	6514	6562	4810
S-300/43/43	6514	7662	4810
S-300/56/56	7864	9061	6160

MACHINE DIMENSIONS***			
S-310 with lifting table	A (mm)	B (mm)	C (mm)
S-310/32/22	5364	9957	3636
S-310/38/22	5924	9957	4196
S-310/43/22	6514	9957	4786
S-310/56/22	7864	11407	6136

LIFE CYCLE SERVICES

Improved performance, more efficient processes, faster help, assurance of availability and smarter working

TEAM & COVERAGE

Largest global service network in the industry with over 1,350 personnel.

INSTALLATION & COMMISSIONING

For a smooth start, we only let proven experts manage your setup.

OPERATION & CONTROL

After teaching your personnel the intuitive control system, our clever apps help to make the operator's life much easier.

MAINTENANCE & SERVICING

To keep things running, we're happy to take a preventative approach. You decide how often and how intensively you want the support to be. As we all know, prevention is better than the cure.

eSHOP & ONLINE ADVANTAGE

A few clicks and it's fixed. Receive exclusive advantages by ordering spare parts online, depending on market availability. shop.homag.com

HOTLINE & READINESS

When there's an emergency, we're here. Direct by phone, digitally via app or video, or with on-site support. We are close to you with over 90 regional service organizations worldwide. With more than 35,000 spare parts immediately available, we can deliver 85% of your orders fast.

TRAINING & EDUCATION

With classroom, live online or eLearning training, we offer flexible options to help you get knowledge. We conduct over 4,000 customer training courses every year, and we even have our own training centers in 19 countries

MODERNIZATION & IMPROVEMENT

Our modernization program is tailored to your machines and processes. We can evaluate your data and situation and advise you on the next step.

ANALYSIS & SUSTAINABILITY

On request, we analyze all your processes with proven tools and procedures (LeanSixSigma). We have a large, certified team of experts for this purpose.

FINANCING & CONSULTING

We offer you tailor-made financing concepts worldwide. With more than 60 years of experience and a close partner network of prominent banks and insurance companies to help us to find the right solution for you, we're always transparent and reliable in processing.

Fast support:

94% resolution rate via our hotline

Close to you:

1,350 service experts worldwide

We get things moving:

Over 1,000 worldwide spare parts shipments each day

No one else has that:

Electronic documentation on over 150,000 machines, available in 28 languages



HOMAG Group AG

info@homag.com
www.homag.com

YOUR SOLUTION