

# EDGETEQ S-300

**Flexible equipment. Precise units. Fast feed.**  
Perfect for reliable edge gluing.





# Perfect edges produced with flexible machines for demanding customers

Individual customer factors, sophisticated products and a wide range of materials — these are all requirements that play a key role in today's wood processing sector. It is therefore important that production is flexible and efficient, especially in woodworking shops and for medium-sized businesses.

HOMAG offers you unbeatable advantages, has an international production network as well as sales and service companies, with a presence in more than 100 countries and around 7000 employees. HOMAG can help make your business competitive and ensure lasting business success. In short:

## YOUR SOLUTION

[MORE AT HOMAG.COM](https://www.homag.com)



## CONTENTS

- 04 The most important features
- 06 Edge parameters
- 08 Models
- 12 powerTouch control system
- 13 Our unit modules
- 28 Technical data
- 30 Apps and digital assistants
- 32 LOOPTEQ return
- 34 Life Cycle Services



# Nine models plus extensions — the choice is yours

## THE MOST IMPORTANT FEATURES

What distinguishes the series is the extensive equipment, including a belt top roll pressure unit for precise workpiece guidance, as well as optimized trimming tools for optimum chip removal and perfect processing quality. A variable feed rate for different performance classes ensures a high level of productivity. In addition, all machines can be extended.

Machines in the EDGETEQ S-300 series are energy efficient and environmentally friendly.

- **High-quality furniture with high-quality edges**
- **More output due to high availability**
- **Low energy requirements**
- **High levels of efficiency**
- **Optimum price/performance ratio**



### **Gluing units for safe hot-melt glue application**

HOMAG gluing units are ideal for quick, solid gluing. The heated gluing roller ensures an optimal adhesive temperature.



### **Edge gluing with PUR**

At HOMAG, PUR glues are processed on the same machines and with the same application unit as EVA hot-melt glues.



### **Zero joint technology with HOMAG airTec**

The units are now equipped with a rotary fan heater, which improves the efficiency of the process, reduces noise and ensures a more cost-effective use of resources.



**Intuitive operation with the powerTouch control system**

Control machine functions directly using the multi-touch monitor in widescreen format. The ergonomic design and numerous help and assistant functions simplify operation significantly.



**Chain track in hardened design**

Increases the lifetime of the chain conveyor in multi-shift operation with consistently high workpiece quality.



**Multi-profile technology**

For easy adjustment of the units at the touch of a button. Saves time and increases quality.



**Controlled chip collection**

The chips are suctioned up in the interior and fed to the extraction hood in a targeted manner. Reduced wear and tear and lower service costs increase profitability and service life. The reduced suction speed lowers energy consumption and costs.

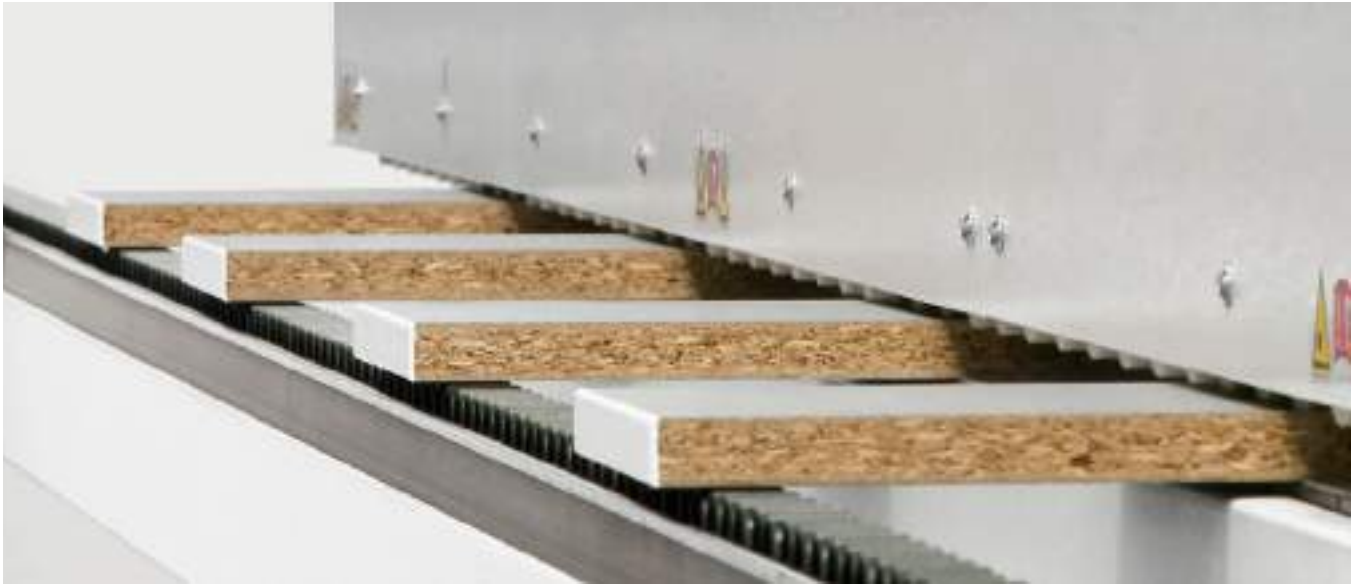

## Material types | Edge parameters

A high level of flexibility is achieved through the processing of all types of edge materials: 0.3-mm melamine, 2-mm ABS/PVC, 8-mm solid strip and veneer. For perfect high-gloss parts, important components such as the motorized top roll pressure unit and the automatic adjustment of the glue joint scrapers are used. Special tracing elements are ideal for processing sharp-angled or blunt-angled parts or parts with hinge holes.

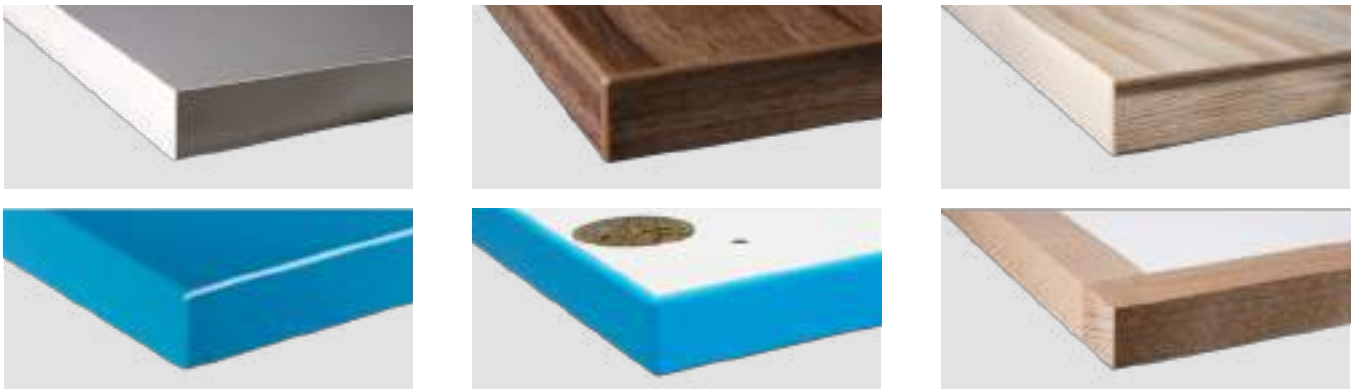

		a	b	c	d	e
	<b>SOLID</b> (mm)	If $b \leq 22$ : min. 70	8–60	0.4–8	65	Max. 30
	<b>ROLLERS</b> (mm)			0.3–3.0		
	<b>STRIPS</b> (mm)			0.4–3.0		



## Increased productivity for your edge banding machine

Workpiece returns of the LOOPTEQ series are an optimal supplement to the machines of the EDGETEQ series. The LOOPTEQ O-200 is ideal for small, narrow and medium-sized workpieces.



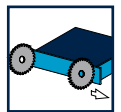
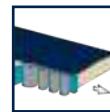

## EDGETEQ S-300 — 1440 FC model

The 1440 FC model of the EDGETEQ S-300 series offers long-term competitive advantages for woodworking shops, as well as for small and medium-sized businesses.

In the basic version, the machine is equipped with a joint trimming unit, a precise gluing station, a dual-motor snipping unit, a trimmer, a radius scraper, a glue joint scraper and a

buffing unit. Depending on the requirements, the machine can be equipped with a Quickmelt gluing station for even more effective EVA adhesive production or a PUR melting unit.

The optionally available automation packages for the machine reduce the setup time and ensure ease of use.



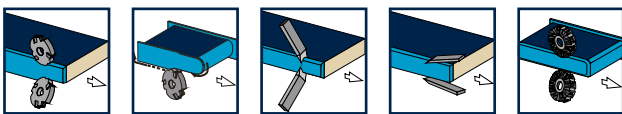

**1** Joint trimming unit

**2** Gluing unit

**3** Snipping unit

**4** Trimming unit

**5** Profile trimming unit

**6** Profile scraper

**7** Glue joint scraper

**8** Buffing unit

## EDGETEQ S-300 — 1450 FC model

To offer an optimal solution, the basic machine of the 1450 FC model is fitted with a joint trimming unit, a precise gluing station, a dual-motor snipping unit, a trimmer and a dual-motor profile trimming unit. A profile scraper with quick-change heads, a glue joint scraper and a buffing unit provide the perfect finish. If required and on request, the machine can be converted into an Edition model offering full automation at the factory. In addition to automating the entire machine, the focus here is

on post-processing. The multi-level technology is used on the trimmer and scraper. The radii can be changed easily at the press of a button since the units are fitted with NC axes. This means that the entire machine is equipped with multi-level technology and the customer is free to change radii in line with their requirements. Full flexibility is guaranteed and all individual customer requests can be taken into account.



## Model 1430 HF

The machine is equipped with a precise Quickmelt gluing station, a swiveling dual-motor snipping unit for straight cuts and chamfer cuts and a trimming unit.

For complete processing, a joint trimming unit, a profile trimming unit, a radius scraper, a glue joint scraper and a buffing unit are also available for the perfect finish.

The Highflex models of the EDGETEQ S-300 series are characterized by their high degree of automation and the extensive unit equipment.

The high level of flexibility allows the machines to be aligned to your needs and guarantees optimal edges.



## Model 1440 AT

The airTec model of the EDGETEQ S-300 series is the right machine for carpenters with high requirements. It always offers the ideal solution for producing the optimum zero joint or other edge processing.

The core of the machine is the gluing station, which acts as a double solution in addition to the airTec activation unit and thereby guarantees a high level of flexibility.

In addition to the magazine, the machine is equipped with a joint trimming unit, a dual-motor snipping unit, a trimmer and a profile trimming unit. A radius scraper, a glue joint scraper and a buffing unit provide the perfect finish. The airTec model offers a high degree of automation and a comprehensive unit equipment.





## powerTouch — The new dimension of machine control units

powerTouch represents the operating philosophy of HOMAG: standardized, simple, ergonomic and evolutionary. The innovative touchscreen operating concept combines design

and function in a completely new generation of control systems.

At the heart of the concept is a large, widescreen multi-touch monitor that allows machine functions to be controlled directly by touch. The entire programming interface is optimized for powerTouch operation and offers numerous help and assistant functions that make working processes substantially easier. Standardized control elements and software modules ensure that all HOMAG edge banding machines from the EDGETEQ S-300 series can be operated in the same way using this new concept. They differ only in a few machine-specific details. This not only simplifies operating different machines, but also makes for greater efficiency by significantly reducing the time spent on training and service.

### Your benefits

- **24" monitor with full HD resolution**
- **Quick overview of the machine status**
- **Easy, user-oriented navigation**
- **Guided path to production readiness using a traffic light indicator**
- **New ergonomic design of the operating panel**
- **Intuitive, natural operation of the machine**
- **Use of gestures, e.g. scrolling, swiping**

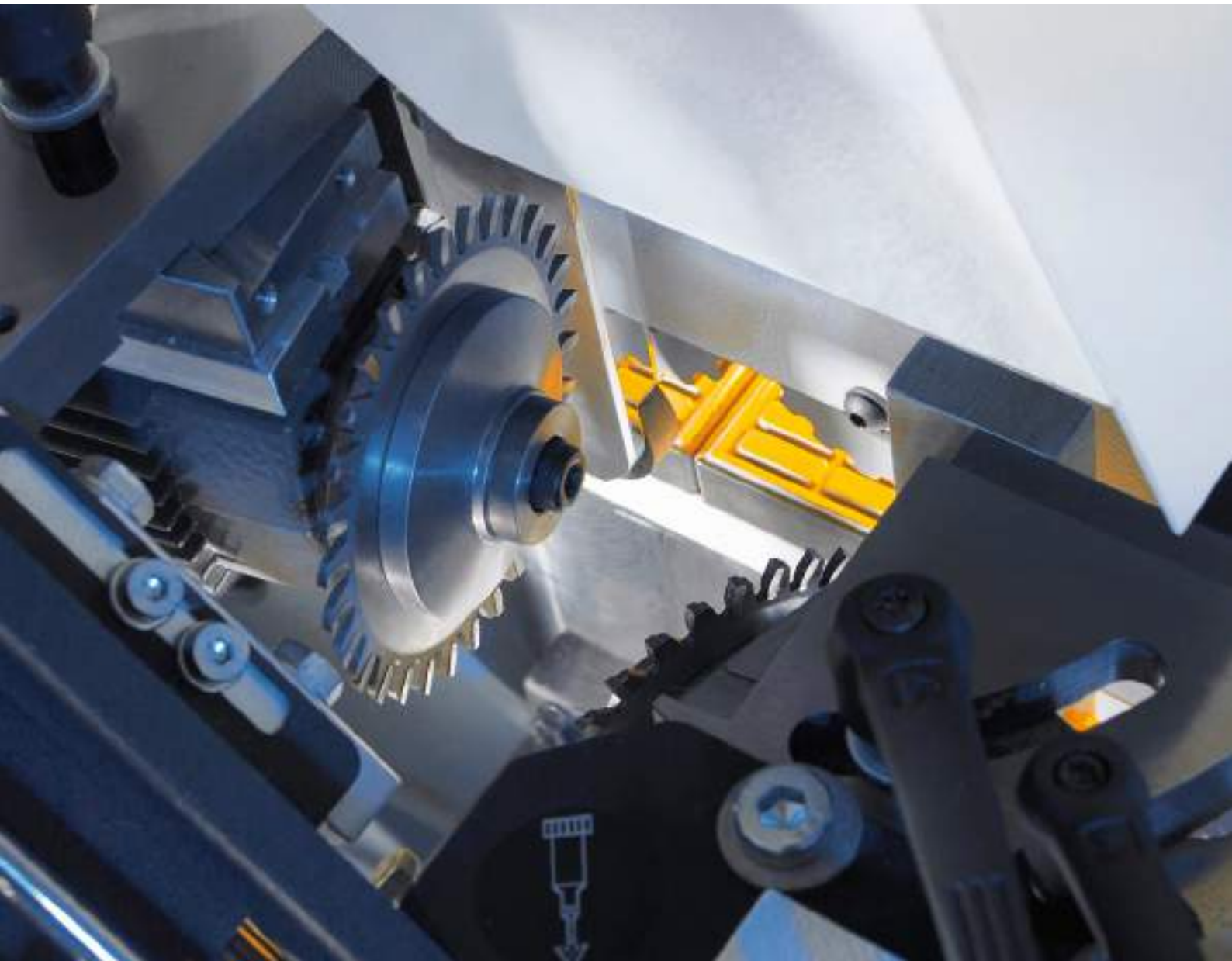

## Our unit modules: The right solution, whatever the requirement

For wide-ranging and diverse processing tasks, we use units from our tried-and-tested unit modules. We are constantly expanding our functions so we can offer you the right solution for new trends. The following pages contain units from the

fields of joint trimming, gluing, cutting, trimming, grooving and finishing. You benefit from a high level of precision, state-of-the-art technology and the ability to produce your products flexibly and efficiently.

## Workpiece feeding

Workpieces need to be fed into machines precisely in order to achieve perfect edge quality. Take advantage of the benefits

our solutions have to offer, such as infeed guides, infeed blocks, sliding carriages and workpiece supports.



### Air cushion table

Air cushion table for safe loading of the machine.

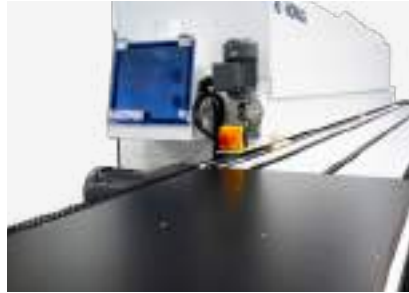

### Air cushion table at outfeed

Available in combination with the infeed table, size: 1275 x 650 mm



### Automatic adjustment of the infeed guide

Program-controlled, precise and repeatedly accurate adjustment of the infeed guide via the servo axis.



### Sliding carriage

Robust linear guide for feeding the workpieces at a right angle.



### Infeed block

For a minimum workpiece distance and safe operation.



### Infeed device

Automatic edge infeed for quick edge changes between different rolls of material.



### Belt top roll pressure unit

Optional belt top roll pressure unit available instead of the standard roller top roll pressure unit.

## Sprayers

Sprayers improve the edge quality throughout processing. Separating agents prevent hot-melt glue residues forming deposits and anti-static agents prevent plastic chips forming deposits.

The adhesive residues can be easily removed using cleaning spray. Lubricants prevent shiny marks on the workpieces and protect sensitive surfaces before trimming.



- 1** Separating agent
- 2** Lubricant
- 3** Anti-static agent
- 4** Cleaning agent

## Joint trimming unit

Our joint trimming units form the basis for precise, absolutely straight and tear-free workpiece edges and glue joints with consistently high product quality.



### Joint trimming unit

Diamond tools ensure perfect cutting and a long service life, as well as optimal glue joint quality. The diameter is 100 mm.



## Safe hot-melt glue application

For solid gluing, it is crucial to achieve an optimum interplay of very different factors. On HOMAG machines, the workpiece preheating, application unit, heated gluing roller, quick-release

system, melting unit, magazine and pressure zone are perfectly aligned.

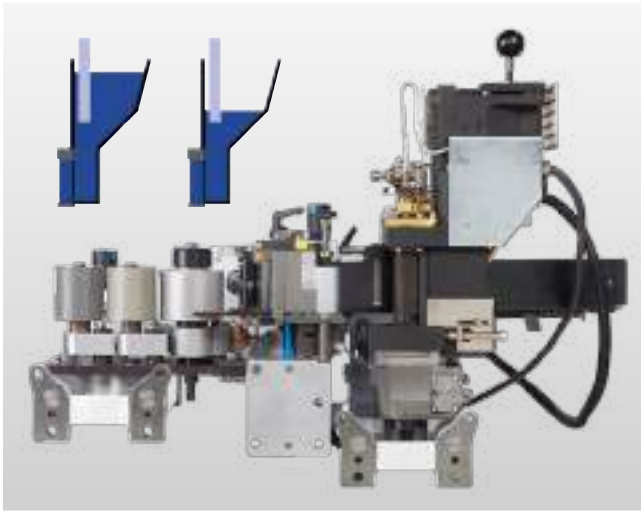

### Top gluing unit – QA65N glue application system

The application unit can be easily removed by means of a quick-change device with pneumatic interface.

### Sensor for checking the fill level of the application unit

Switching to a lower glue level guarantees a fast heat-up time for processing small batch sizes.

### Your benefits at a glance – QA65N

- Short heat-up time thanks to sensor-controlled level regulation (two levels can be selected)
- The application unit can be easily removed by means of a quick-release lock for melting hot-melt glue either automatically or manually
- Gluing roller with integrated heating unit guarantees a constant temperature and viscosity for all workpiece thicknesses
- Electro-pneumatic clamping of the gluing roller and tank prevents glue contamination to the rear edge of the workpiece
- Tracing pad prevents wear to the application roller and ensures a constant glue film thickness
- Gluing roller lifts when feed stops



### Workpiece preheating with heaters

High-strength gluing due to optimum workpiece preheating.



### Pressure zone

Heavy pressure zone up to 8 mm edge thickness and 60 mm panel height for optimum glue joint quality.



### Roller counterpressure

Roller counterpressure for sensitive edge material.





**Automatic glue quantity metering**

The application quantities are implemented quickly and easily via the powerTouch user interface for automatic glue quantity metering. The glue is applied in synchronous operation.

Precisely and quickly adjustable glue quantities result in:

- Optimal gluing quality
- Higher availability and performance
- Greater cost efficiency

## Systematic gluing



**Melting unit in three versions:**

**EVA, PUR as well as EVA and PUR**

- Efficient processing, as the adhesive is pre-melted
- Melting capacity max. 2.5–4 kg/h
- With the combination EVA and PUR, changing the type without cleaning is fast and easy thanks to interchangeable containers



**Interchangeable container**

Easy to use for EVA and PUR adhesives



**Melting unit for EVA**

High availability, as the adhesive is melted only in accordance with adhesive consumption. The Quickmelt system ensures perfect glue quality.

- Melting capacity max. 8 kg/h
- Swiveling



## PUR glue and HOMAG – a strong connection

Using polyurethane (PUR) hot-melt glue increases the resistance of furniture to moisture and heat. It is ideal for use on furniture in damp areas such as bathrooms, kitchens and laboratories.



### Your HOMAG PUR benefits at a glance

- One application unit for all types of adhesive
- No additional application unit required
- Fast, powerful thin-film application by means of gluing roller with integrated heating unit
- To be used as standard from the entry-level model to the high-end machine



**Vacuum container**

- Compact, portable container for the PUR application unit
- No vacuum pump and no nitrogen necessary



**Service station**

- Preheating and cleaning station for the QA65N application unit with one storage position
- High flexibility thanks to up to two vacuum containers for one QA65N application unit or one PUR melting unit with 2.5 kg/h capacity
- No vacuum pump and no nitrogen necessary
- With optional accessories also for application units for the powerEdge Pro/Pro Duo CNC edge banding unit



**Service station**

The image shows the application unit in the holding device for preheating.

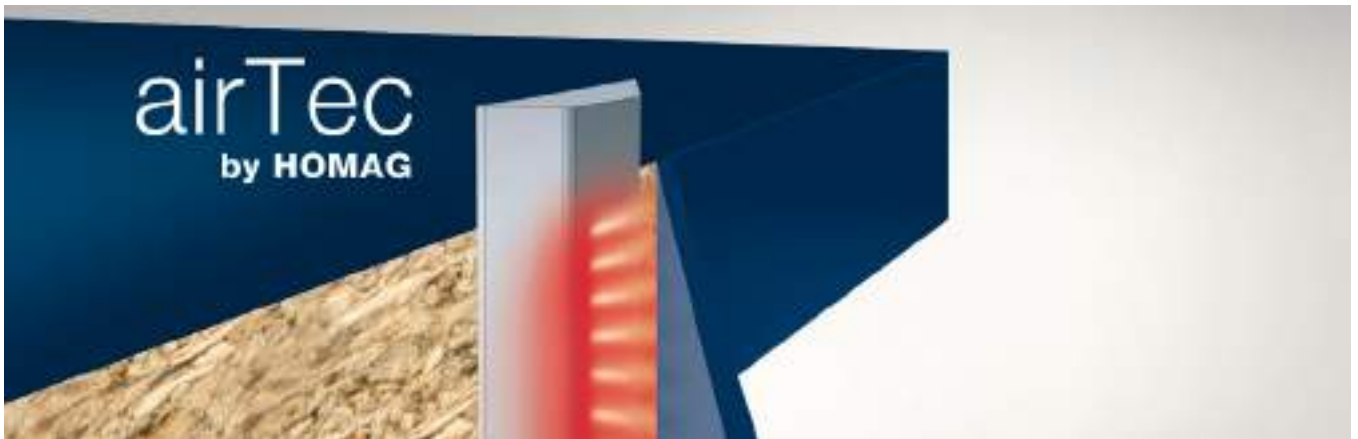

## airTec — an ideal introduction to zero joint technology

The airTec process has established itself as the optimum zero joint solution for woodworking shops and medium-sized companies. HOMAG's response to increases in demand is an innovative and more efficient airTec solution that ensures a more cost-effective use of resources. At the core of the

airTech unit is a rotary fan heater, which provides increased efficiency and a significantly reduced noise output. All laser-compatible edging types that are currently available on the market can be processed with airTec. This means great flexibility for all materials and colors.

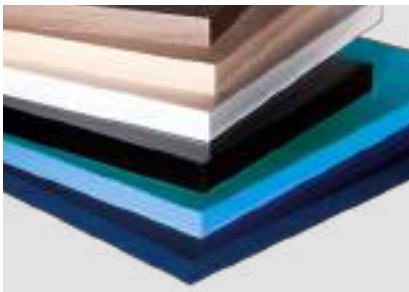

### Gluing edges "without joints"

In the airTec process, the edge and panel are bonded using hot air. This requires the use of special edges. These consist of a decorative layer and a functional layer. Using the HOMAG airTec unit, the functional layer is melted at a constant temperature and volume outflow and optimally applied to the narrow surface.



### Easy integration

The airTec reactivation unit is installed in such a way that it is possible to work with either the standard application unit or the airTec system.

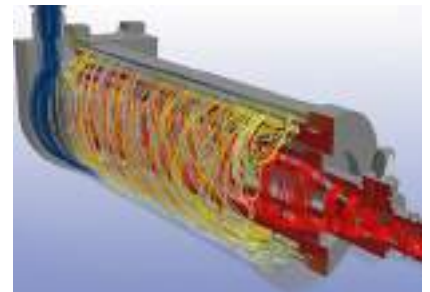

### Innovative rotary fan heater

This source of energy heats the air and simultaneously serves as heat storage that can then be used to heat the air again. In addition, less air is required and the heating effect on the surrounding area is minimized. Any noise is almost exclusively produced during the activation process and is below the noise level of other processing units.

## Snipping unit for cutting the overhangs on the front sides

The snipping unit prepares the workpieces for subsequent trimming perfectly. The front side can be snipped straight or with a chamfer.



### Snipping unit

Exact snipping cut via a robust snipping unit with a highly precise linear guide. Swivels to easily adjust for chamfer or straight snipping (optional: adjustment via pneumatics).

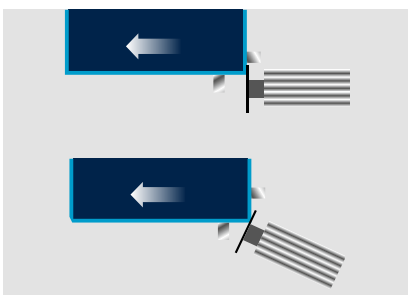
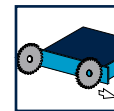

### Automation in the standard version

Programmable adjustment of the snipping motor for chamfers/straight lines, for a quick change between straight-line snipping and cutting with a chamfer.

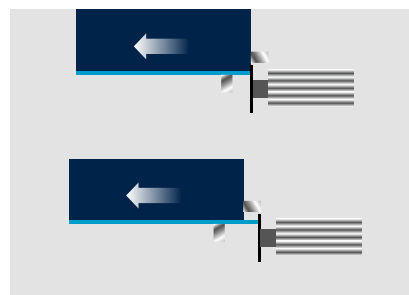

### Can be automated

For a quick change between flush snipping, e.g. of solid strips or shelves, and cutting with an overhang, e.g. for post-trimming with a profile trimming unit.

## Trimming units for flush trimming

The pre-trimming and fine trimming units offer the perfect solutions for processing edge overhangs. The trimming units are only equipped with tools that collect the chips in a controlled manner.



### Pre-trimming

For pre-trimming all standard edge types.



### Trimming unit

Flexibility for different edge thicknesses and profiles thanks to NC axes.

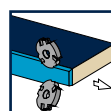
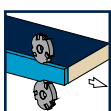

## Trimming unit with multi-level technology

The range of edges and panel materials is continually growing and so is the demand for flexibility. It is immaterial if edges are made from plastic, solid wood or veneer, or if workpieces have high-gloss surfaces. The multi-level trimming unit always offers the optimum radius for frequently changing applications, and therefore the best results.



### Multi-level trimming unit MS 40/45

Fully automatic changeover to three different profiles using servo motors\*. The image shows the nesting package.\*

\* Servo motors: Servo drives consist of motors with an infinitely variable adjustment. They impress thanks to a high positioning accuracy and are particularly suitable for small positioning distances.

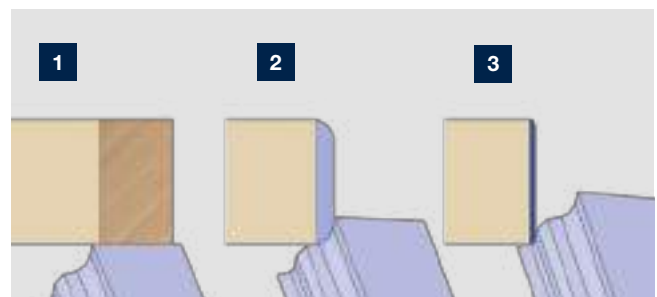

**1** Flat (MS 40/45)

**2** Profile 1

**3** Profile 2

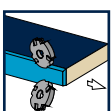

# Profile trimming units

The profile trimming units are universal. As a user, you have the option to manually adjust the units or perform programming using the control system.



### FF6210 profile trimming unit

Optimum profile trimming without making adjustments thanks to linked DIA tool and detector roller. Equipped with automatic adjustment between thin and thick edges. Workpiece thickness 60 mm.

#### Can be automated

Automatic adjustment to two different profiles possible.

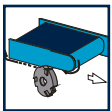

### NEW: TWO-PROFILE TECHNOLOGY

#### Highlights of the new tool system

- Robust mechanics
- Closed system that can be easily maintained from the outside without being dismantled
- Sensory detection of the tool levels — for clear determination of the tool position
- Safe tool positioning thanks to special adjusting axes



### MF 50 multi-functional trimming unit

For processing edge overhangs on the top and bottom edge of the workpiece and for copying the corners of the front and rear edge. Equipped with automatic adjustment between thin and thick edges. Workpiece thickness 60 mm.

#### Can be automated

Automatic adjustment to two different profiles possible.

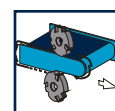





**FF 20 profile trimming unit**

For rounding corners on thick PVC edges, as well as top edges on post-forming and soft-forming parts. Equipped with automatic adjustment between thin and thick edges. Workpiece thickness 60 mm.



**Structural shelves**

Profile trimming is also possible on workpiece sides without an edge. This applies not only to structural shelves, but also to upper and lower shelves, shelf inserts and partition panels.

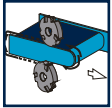

## Groove milling unit

A swiveling groove milling unit is available for grooving. If required, the workpiece underside and the front side can be grooved.



**Groove milling unit**

A swiveling groove milling unit is available for grooving. If required, the workpiece underside and the front side can be grooved. On the 1450 FGC model.



**Safety equipment**

For grooving in solid strips in synchronous rotation.

## Finishing units

With optimally matched finishing units, HOMAG makes the quality of your products perfect.



### Profile scraper unit

Unit for smoothing radii and chamfers. Equipped with changer heads to allow rapid profile changes.

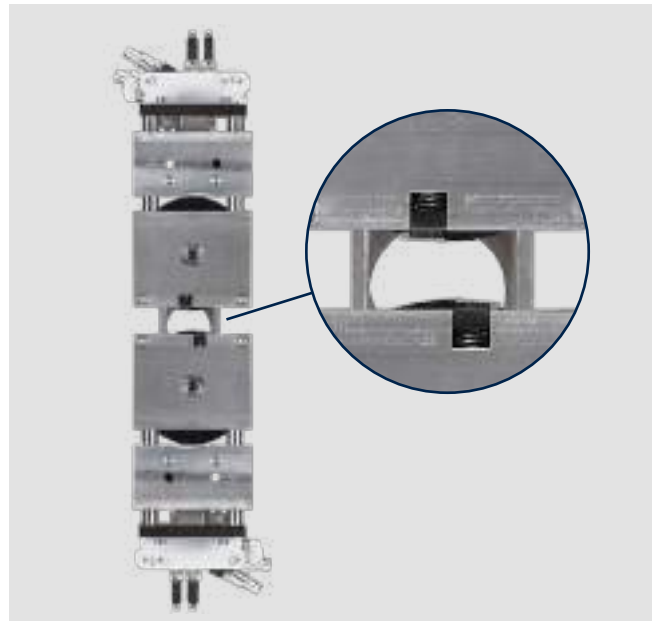
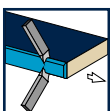

### Glue joint scraping unit

For the perfect finish.

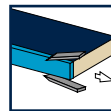

### Buffing unit

For polishing edges for a natural color.

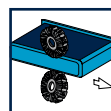

## Finish with multi-level technology

The range of edges and panel materials is continually growing and so is the demand for flexibility. It is immaterial if edges are made from plastic, solid wood or veneer, or if workpieces have high-gloss surfaces.

The multi-level scraper always offers the optimum radius for frequently changing applications, and therefore the best results.



### Multi-level scraper unit MZ 40

Fully automatic changeover to two different profiles using servo motors\*.

\* Servo motors: Servo drives consist of motors with an infinitely variable adjustment. They impress thanks to a high positioning accuracy and are particularly suitable for small positioning distances.

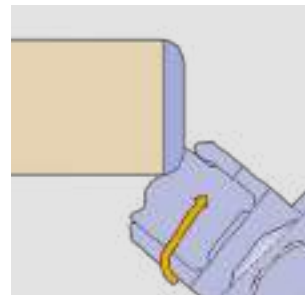

Profile 1

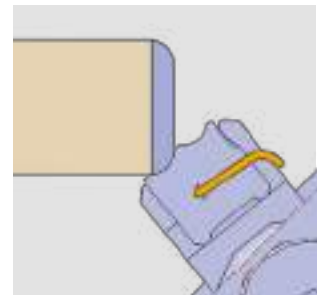

Profile 2

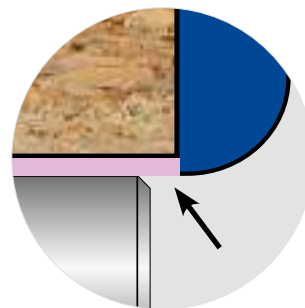

Optimum compensation for protective films

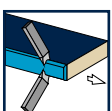

**TECHNICAL DATA OF THE EDGETEQ S-300 SERIES**

	Model 1430 FC	Model 1440 FC	Model 1450 FC	Model 1450 FGC
<b>Overall length (mm)</b>	4773	5273	5773	5773
<b>Feed (m/min)</b>	8–14			
<b>WORKING DIMENSIONS</b>				
<b>Workpiece width (mm) *</b>				
for workpiece thickness 8–22 mm	70			
<b>Workpiece thickness (mm)</b>	8–60			
<b>Edge thickness rollers (mm)</b>	0.3–3			
<b>Edge thickness strips/moldings (mm)</b>	0.4–8			

\* Dependent on the workpiece thickness

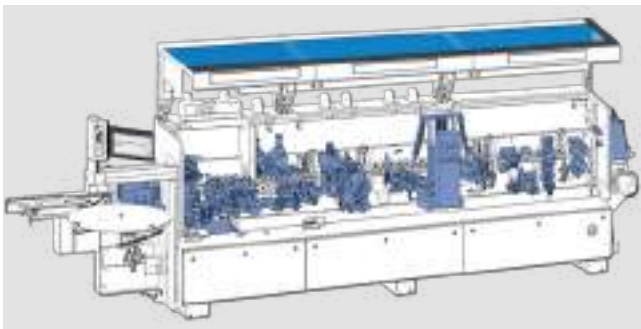
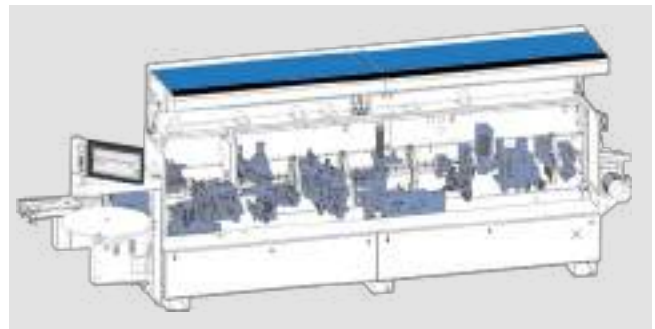
**Model 1430 FC****Model 1440 FC****Model 1450 FC****Model 1450 FGC**

**TECHNICAL DATA OF THE EDGETEQ S-300 SERIES**

	Model 1430 HF	Model 1440 HF	Model 1440 E	Model 1450 E	Model 1440 AT	
<b>Overall length (mm)</b>	4773	5273	5573	6075	5573	
<b>Feed (m/min)</b>	8-14					
<b>WORKING DIMENSIONS</b>						
<b>Workpiece width (mm) *</b> for workpiece thickness 8-22 mm				70		
<b>Workpiece thickness (mm)</b>				8-60		
<b>Edge thickness rollers (mm)</b>				0.3-3		
<b>Edge thickness strips/moldings (mm)</b>				0.4-8		

\* Dependent on the workpiece thickness

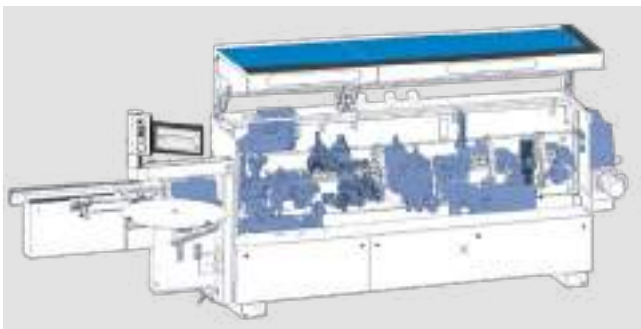

**Model 1430 HF**

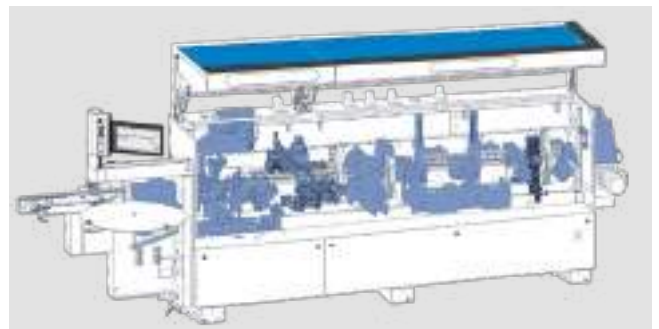

**Model 1440 HF**

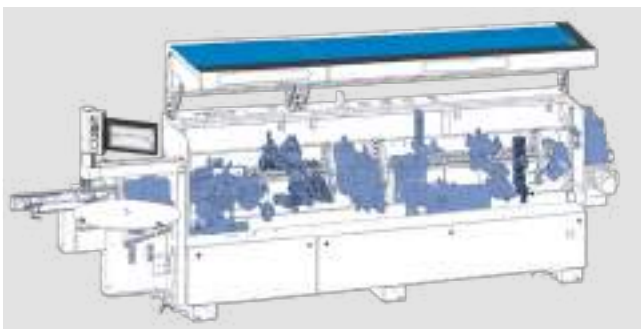

**Model 1440 E**



**Model 1440 AT**

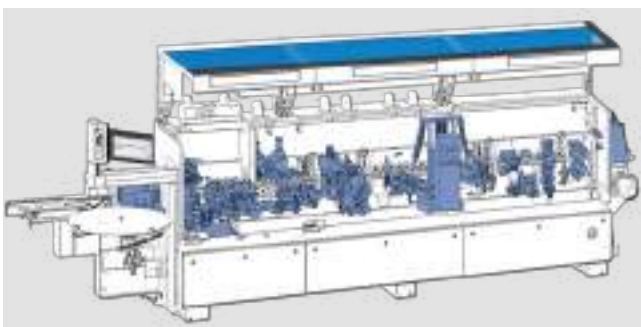

**Model 1450 E**



## Apps and digital assistants.

Quick and easy support in your machine environment.

Some people still use pen and paper to create their cutting patterns. But they look at their smartphone if they want to know what the weather is like – instead of looking out of the window. We asked ourselves: why not combine the best of both? Our apps and digital solutions make your everyday work easier: machines, material, tools, cutting patterns, components – you always have everything in your pocket or on your desk.



More information at [digital.homag.com](http://digital.homag.com)

### WE HAVE DEVELOPED POWERFUL AND SMART SOLUTIONS FOR YOU:

- ✓ Always low investment
- ✓ Always up to date (no updates necessary)
- ✓ Always easy to use (no complex software)
- ✓ Always helpful

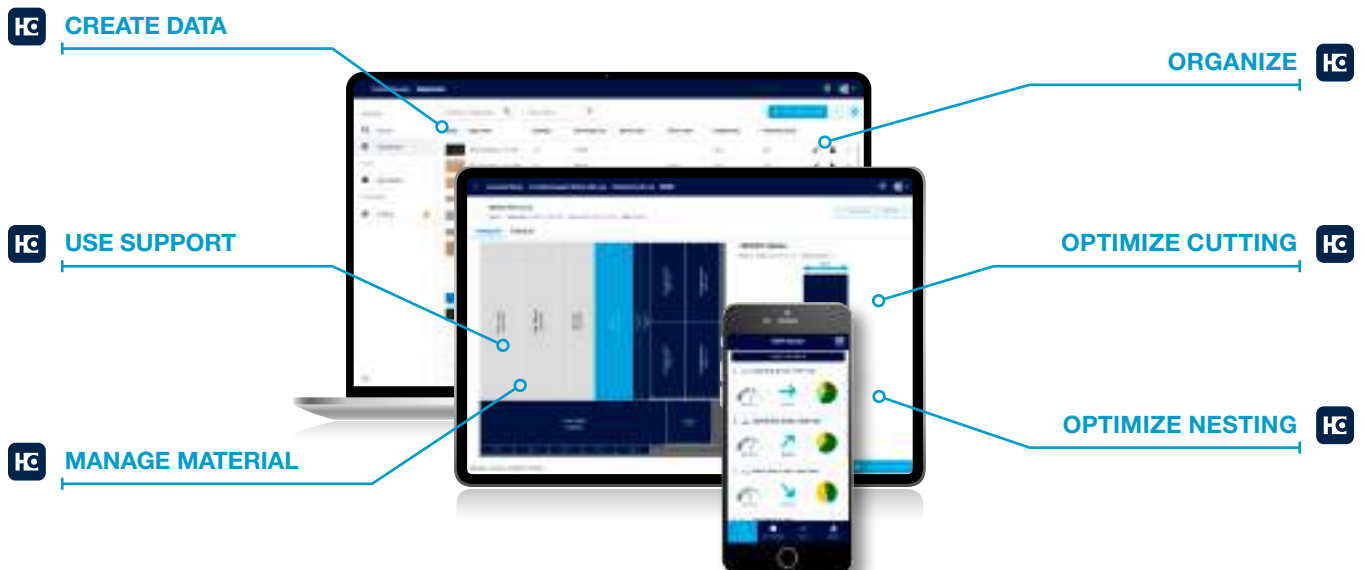

## The right machine for your needs

The machines from the S-300 series offer you comprehensive solutions for manufacturing your products flexibly and economically. Whether living room and bedroom furniture, functional office furniture, superior shop fitting solutions or batch size 1 production for

individual requirements — HOMAG offers a well-designed product range to meet any requirement. Using these machines can also make current trends easily achievable for you and your employees.



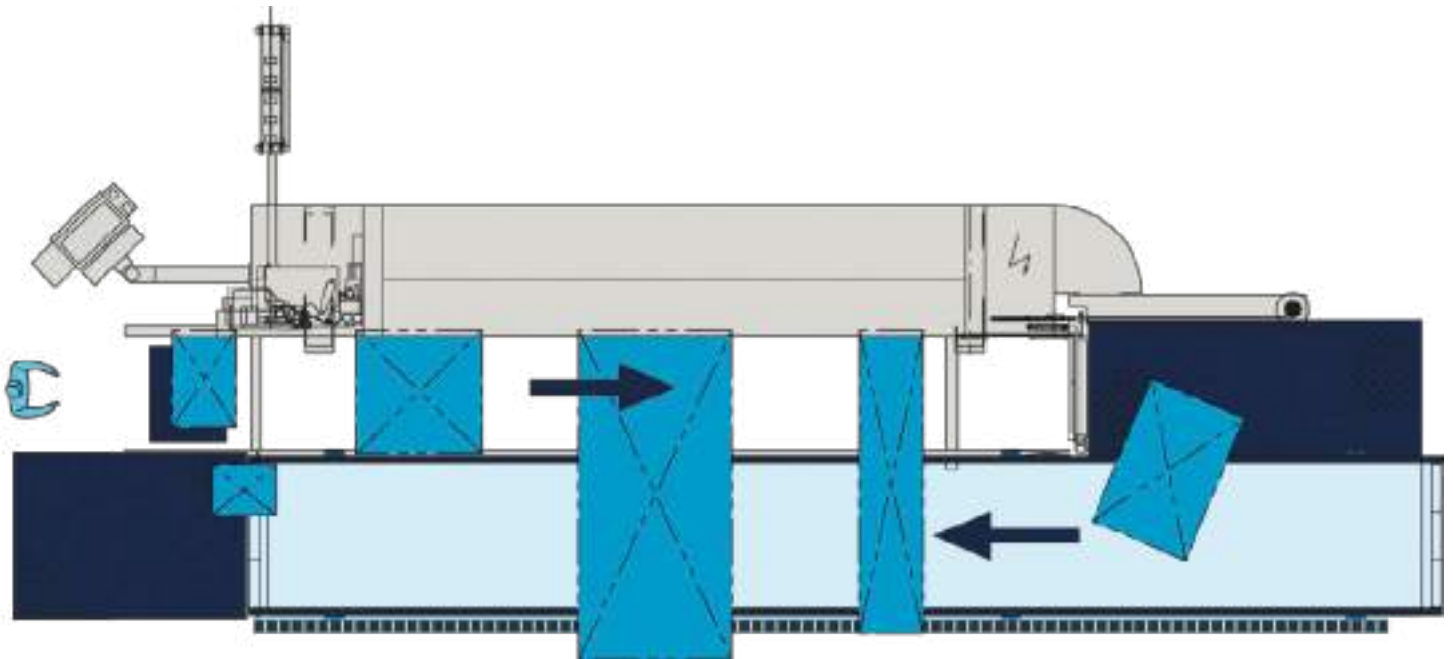

EDGETEQ S-500 with workpiece return LOOPTEQ

## LOOPTEQ O-200 and LOOPTEQ O-300 return: Increased productivity for your edge banding machine

This indispensable helper makes the return system of your HOMAG EDGETEQ even more efficient. Single-person operation enables you to optimize your workpiece return flow, resulting in a streamlined and efficient production process.

Your HOMAG machine of the EDGETEQ S-300 series can be freely combined with this return. It is ideally suited for customers with small, narrow and medium-sized workpieces.

### Your benefits at a glance

- **Fast return on investment** — pays for itself from just nine hours of operating time per week
- **Flexible personnel organization** thanks to cost-effective single-person operation
- **Ergonomic working** — manual parts handling is reduced to a minimum
- **Better quality control** — quick response to material adjustments



## Technical data

	LOOPTEQ O-200	LOOPTEQ O-300 TFU 140/20	LOOPTEQ O-300 TFU 140/25
Workpiece length (mm)	300–2500	300–2500	240–2700
Workpiece width (mm)	50–1450	60–800	60–1000
Workpiece thickness (mm)	8–60	8–60	8–60
<b>FOUR-SIDED PROCESSING*</b>			
Min. workpiece size (mm)	300 x 300	300 x 80	240 x 80
Max. workpiece size (mm)	1450 x 1450	2000 x 800	2500 x 1000
<b>MISCELLANEOUS</b>			
Max. workpiece weight (kg)	50	50	50
Surface weight (kg/m <sup>2</sup> )	25	25	25

\*In four-sided processing, larger parts can be returned or ejected with manual assistance in the event of transverse offset or rotation.

### By the way

The return pays for itself within one year, starting from nine hours of use per week!

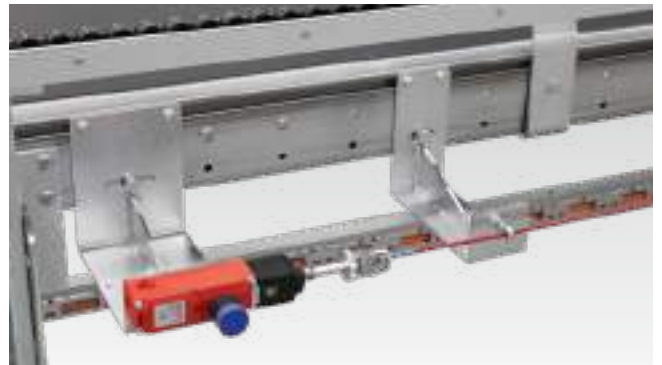

#### Safety equipment

Pull cord longitudinally to the return belt.



#### Cleaning the belts

For optimum protection against dust and chips.



#### Return control system

The parameters for the operating modes of the return are integrated in powerTouch.

# VALYOU

Our Mission, Your Performance.

## LIFE CYCLE SERVICES

Improved performance, more efficient processes, faster help, assurance of availability and smarter workin

### TEAM & COVERAGE

Largest global service network in the industry with over 1,350 personnel.

### INSTALLATION & COMMISSIONING

For a smooth start, we only let proven experts manage your setup.

### OPERATION & CONTROL

After teaching your personnel the intuitive control system, our clever apps help to make the operator's life much easier.

### MAINTENANCE & SERVICING

To keep things running, we're happy to take a preventative approach. You decide how often and how intensively you want the support to be. As we all know, prevention is better than the cure.

### eSHOP & ONLINE ADVANTAGE

A few clicks and it's fixed. Receive exclusive advantages by ordering spare parts online, depending on market availability. [shop.homag.com](http://shop.homag.com)

### HOTLINE & READINESS

When there's an emergency, we're here. Direct by phone, digitally via app or video, or with on-site support. We are close to you with over 90 regional service organizations worldwide. With more than 35,000 spare parts immediately available, we can deliver 85% of your orders fast.

### TRAINING & EDUCATION

With classroom, live online or eLearning training, we offer flexible options to help you get knowledge. We conduct over 4,000 customer training courses every year, and we even have our own training centers in 19 countries

### MODERNIZATION & IMPROVEMENT

Our modernization program is tailored to your machines and processes. We can evaluate your data and situation and advise you on the next step.

### ANALYSIS & SUSTAINABILITY

On request, we analyze all your processes with proven tools and procedures (LeanSixSigma). We have a large, certified team of experts for this purpose.

### FINANCING & CONSULTING

We offer you tailor-made financing concepts worldwide. With more than 60 years of experience and a close partner network of prominent banks and insurance companies to help us to find the right solution for you, we're always transparent and reliable in processing.

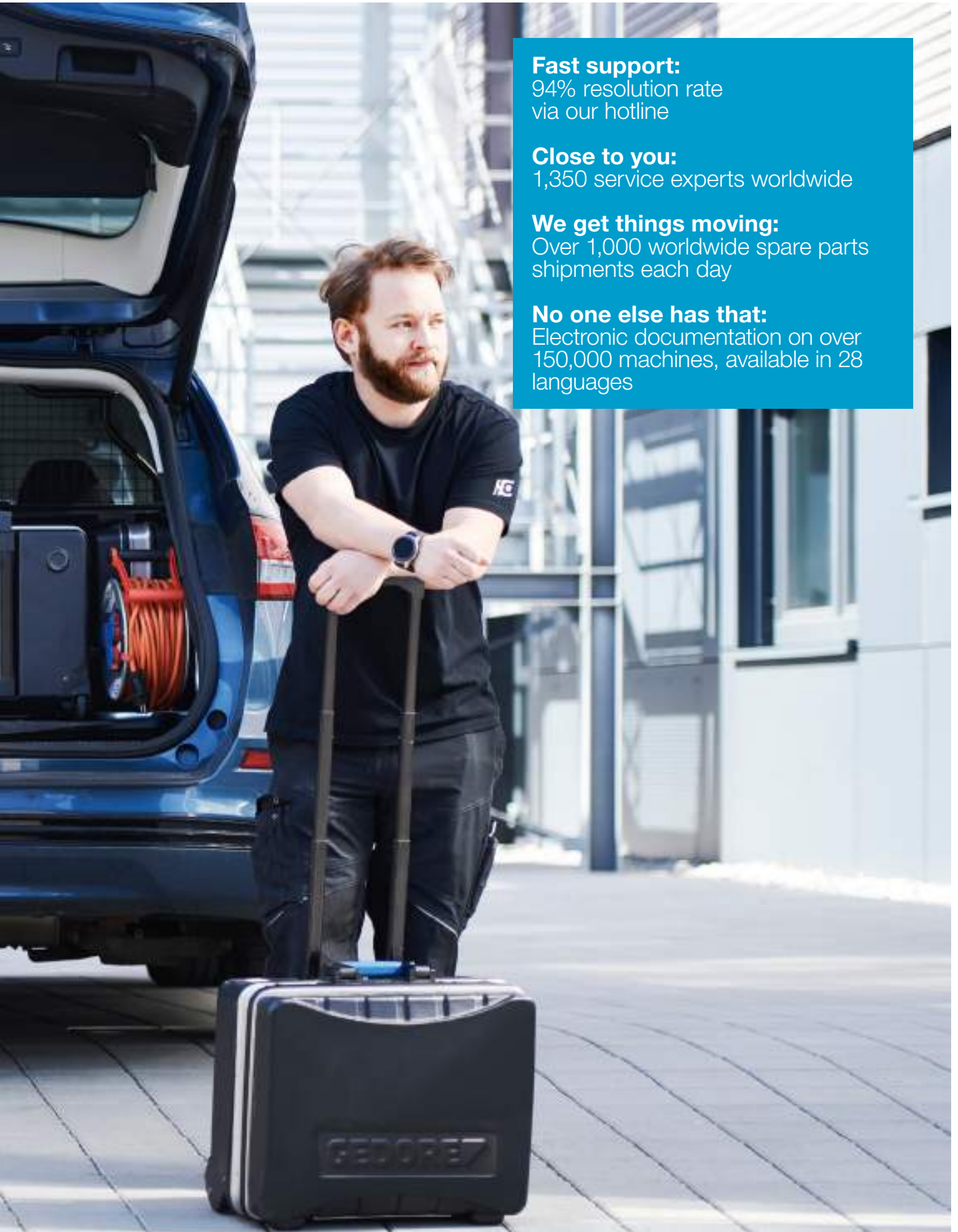

**Fast support:**  
94% resolution rate  
via our hotline

**Close to you:**  
1,350 service experts worldwide

**We get things moving:**  
Over 1,000 worldwide spare parts  
shipments each day

**No one else has that:**  
Electronic documentation on over  
150,000 machines, available in 28  
languages

Status 06/22 | Technical changes, print errors and mistakes reserved. Pictures may show special equipment.



**HOMAG Group AG**  
info@homag.com  
www.homag.com

**YOUR SOLUTION**