

CENTATEQ P-110

The flexible basis for CNC machining.
360° freedom. Unlimited possibilities.







CENTATEQ P-110 – small space, big possibilities

Compact technology, a reduced footprint and operational convenience next to the machine – these are the cornerstones of the machine concept. You will find 3-, 4- and 5-axis solutions. For entering the world of sophisticated horizontal CNC processing.

YOUR SOLUTION

CONTENTS

| | |
|----|-----------------------------|
| 04 | The Concept |
| 06 | The models |
| 08 | 360° more freedom |
| 09 | Option: Convenience Package |
| 10 | Quality |
| 12 | Applications |
| 14 | HOMAG drilling technology |
| 16 | Routing spindles |
| 18 | Tool changer systems |
| 20 | Aggregates |
| 22 | Console table |
| 26 | Matrix table |
| 30 | Software |
| 34 | Life Cycle Services |
| 36 | Summary Configurations |
| 38 | Technical data |

The P-110 concept

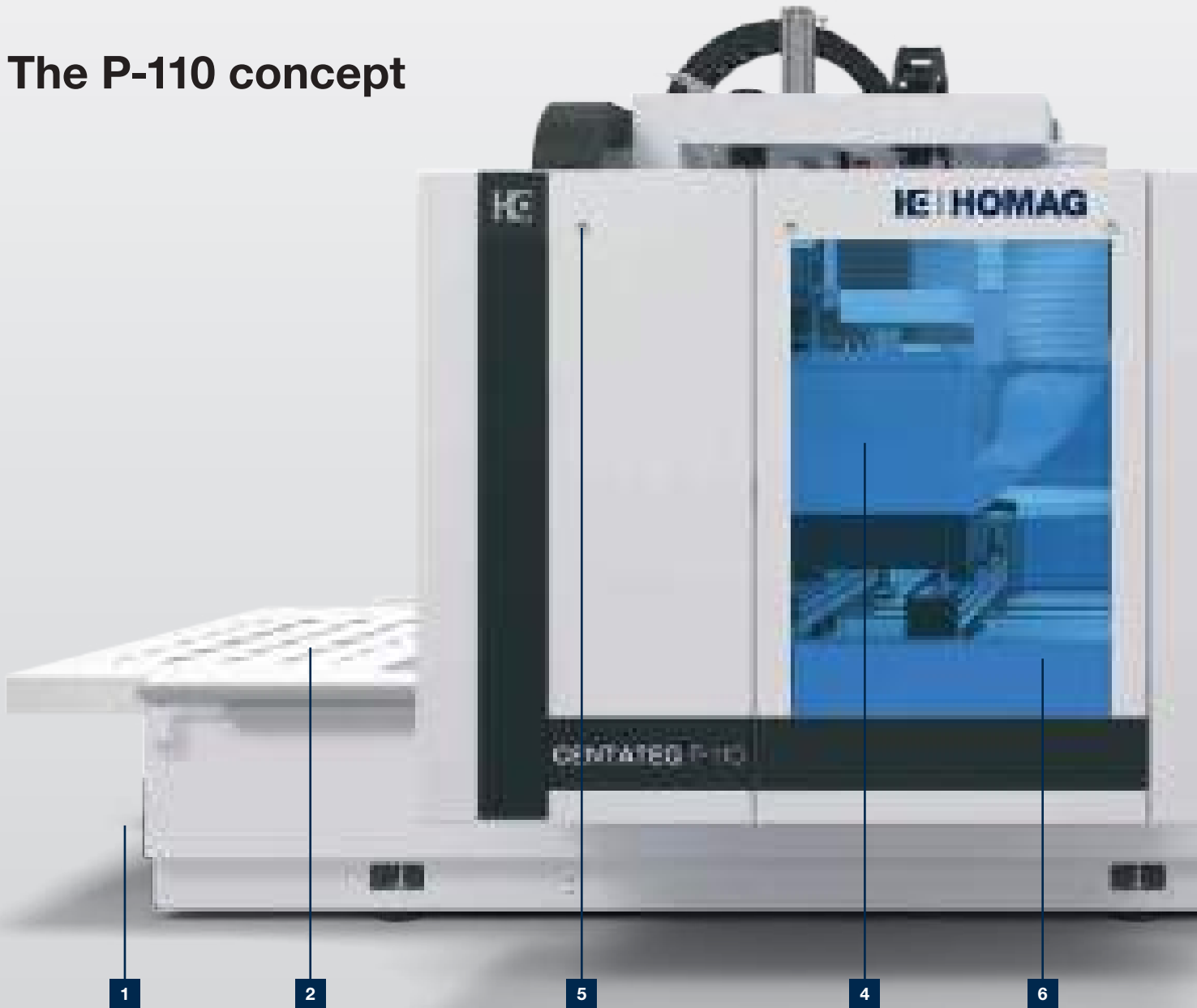

CENTATEQ P-110

- 3-axis technology
- 4-axis technology
- 5-axis technology



Convenience package (Option) – relieving the working area, starting, pausing and continuing the program, raise and lower the hood can easily be activated via pressing a button directly at the machine. The light indicator of the push buttons shows the status at any time.



Maximum insight into the machine and at the same time optimal protection of the operators by large windows. Drill changes and service can be carried out easily from the front side of the machine.

1 Chip conveyor belt (Option): Simple disposal of the offcuts and chips using the integrated chip belt. A waste box can be easily pushed onto the belt from the front.

3 Convenience package (Option): Relieving the working area, starting, pausing and continuing the program, raise and lower the hood can easily be activated via pressing a button directly at the machine. An integrated proximity scanner for intelligent pausing is included.

2 Deposit position to the left on the machine for clamping equipment.

5 safeScan (Option): Scanner for contact-free protection of the positioning of the automatic table and feed reduction in conjunction with the Speed Pack.

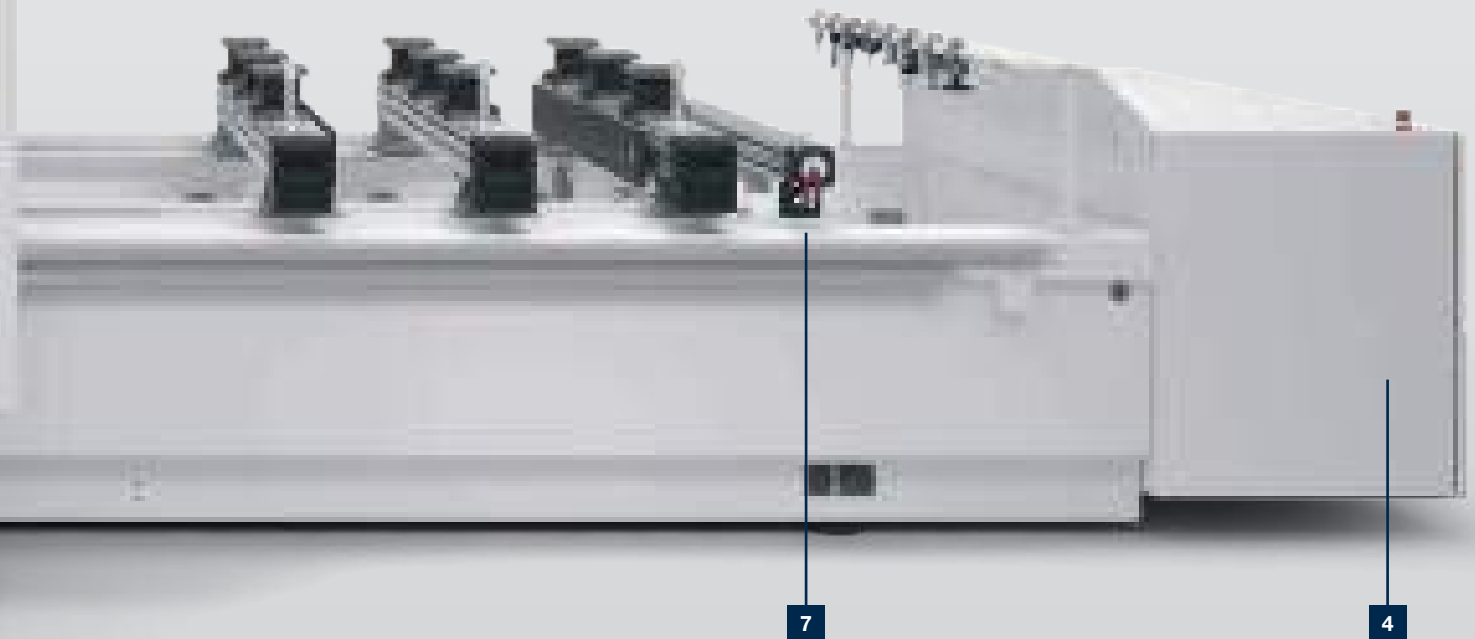

7 **Button for program start** – each one at the left and right hand stop profile act as program start for the processing.

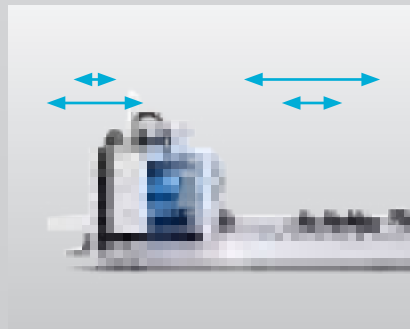

Dynamic alternating operation without fixed field division. This means that even in the case of long parts on one side of the machine a short part can still be placed on the other side.



Smart support for support and maintenance using the service pad and display of machine status on smart devices.

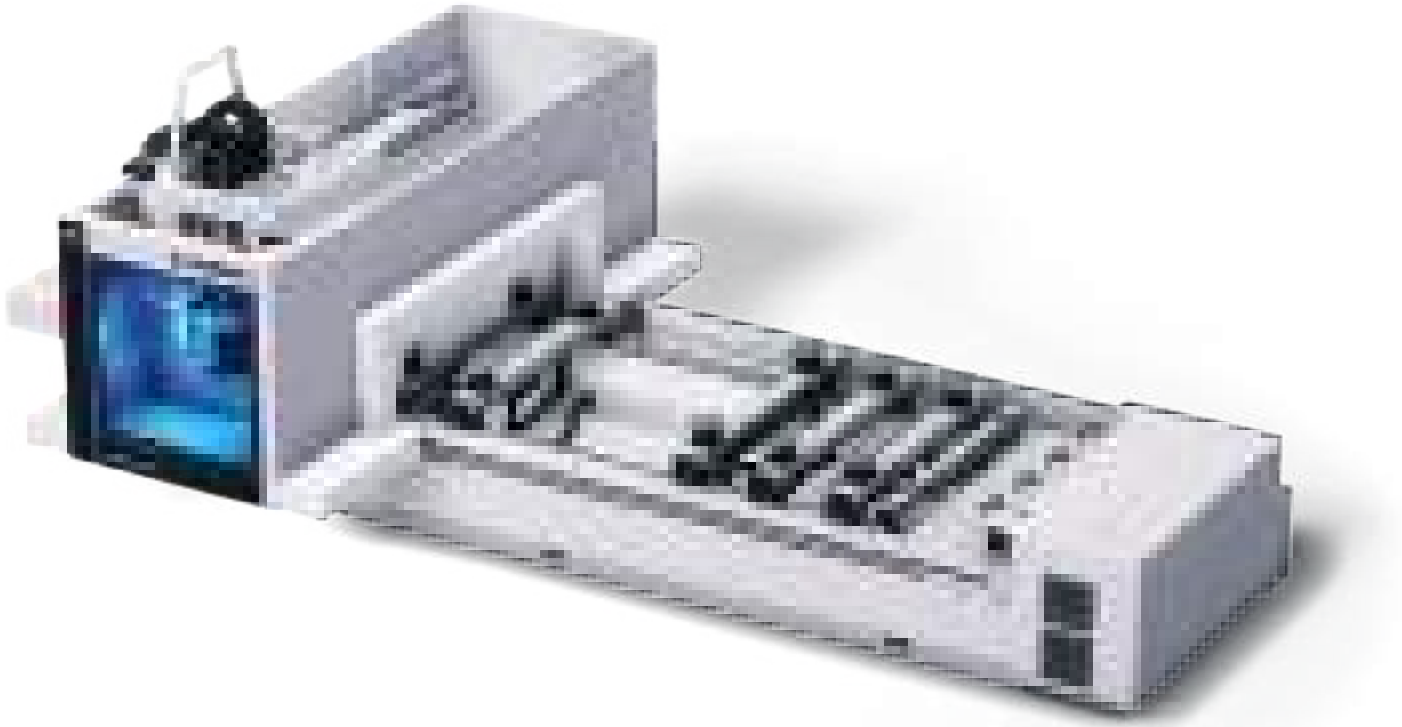

Model 4-axis

4-axis configuration with console table with X-working field 3,100 mm with safety technology stripe bumper.

**Bet that a model of the
CENTATEQ P-110 is just right for you....!**

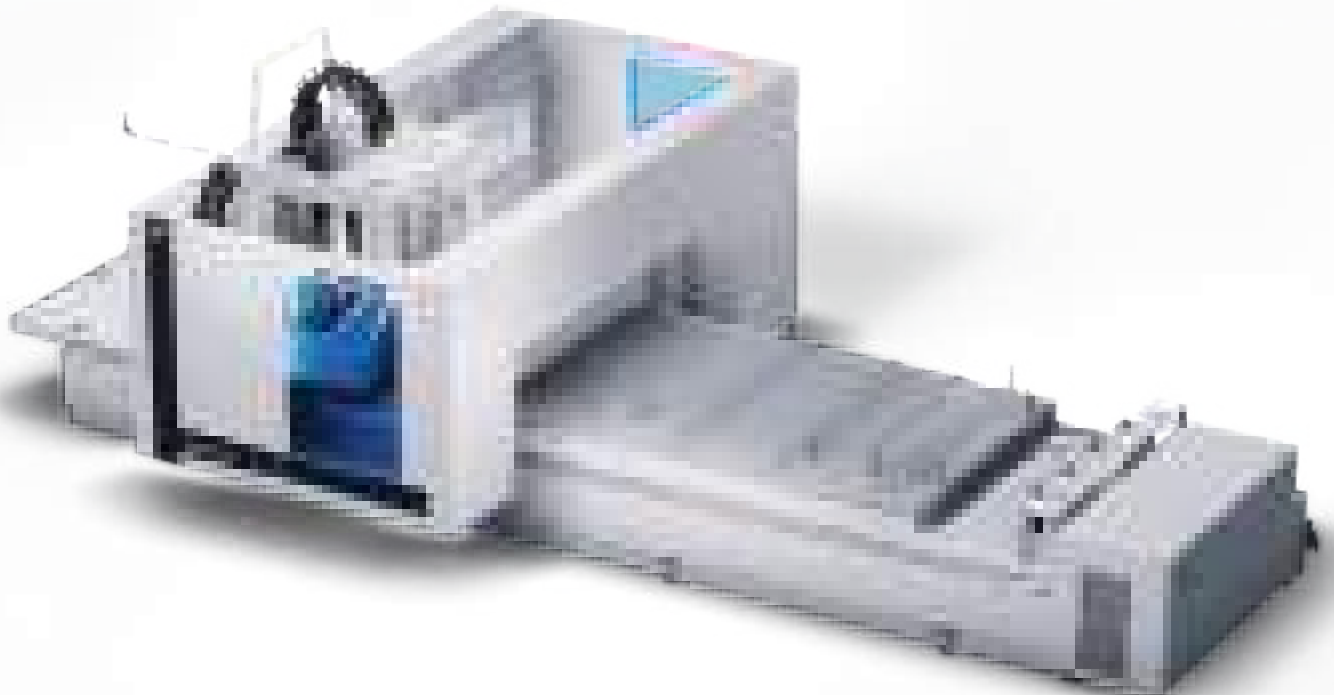

Model 5-axis with matrix table

5-axis configuration with aluminium grid table with X-working field 4,200 mm with safety technology surface bumper.

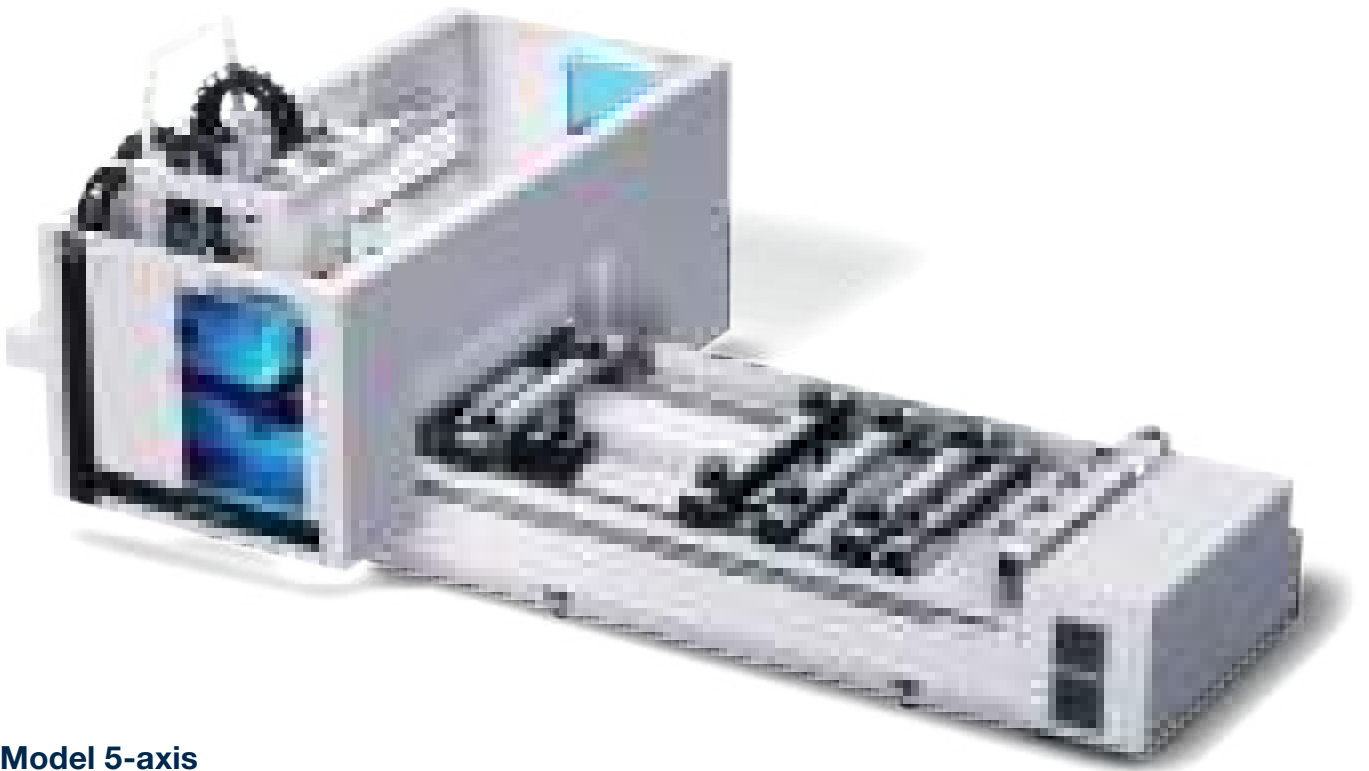

Model 5-axis

5-axis configuration with console table with X-working field 3,100 mm with safety technology surface bumper.

The requirements of the market are diverse, and so are our solutions. For the implementation of individual wishes, we offer 4 models with individual configurations. Choose exactly what suits you from a wide range of tables, technical configurations and safety technology.

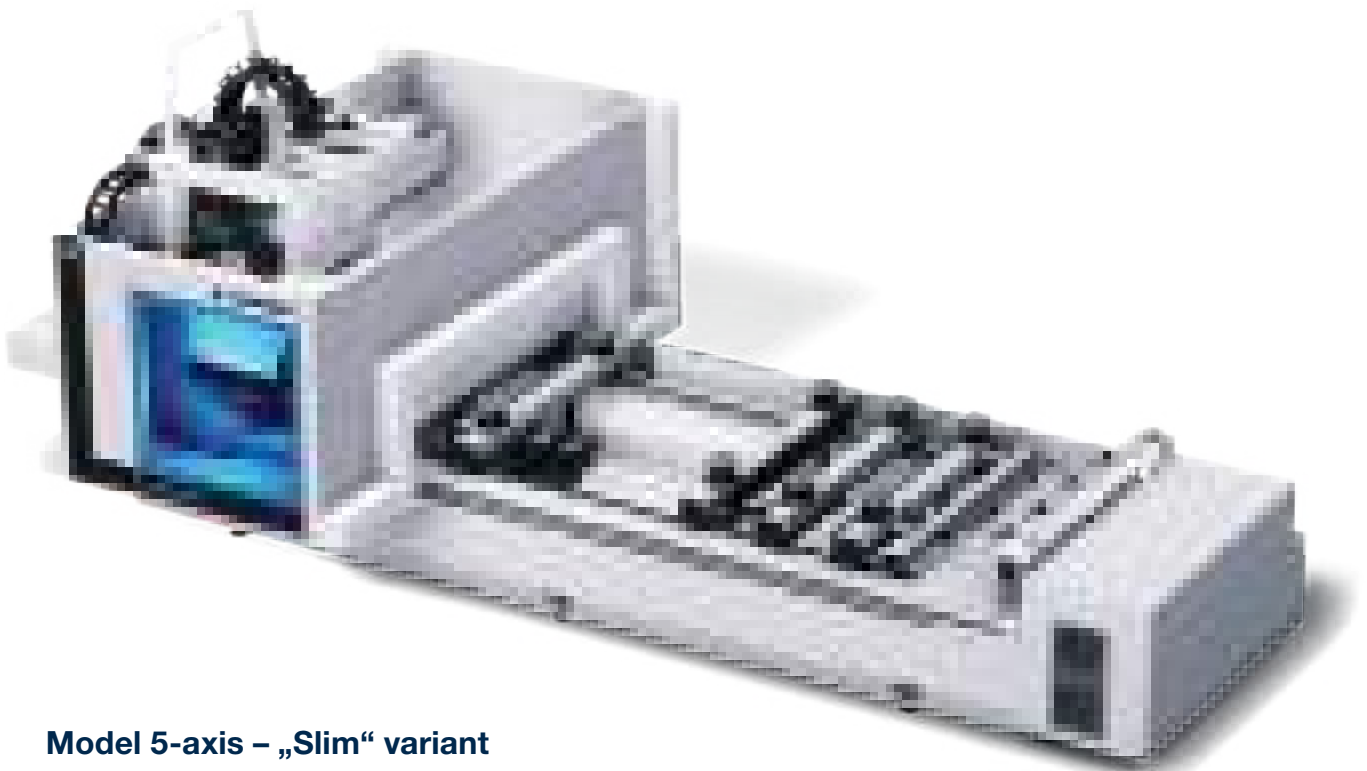

Model 5-axis – „Slim“ variant

5-axis configuration with console table with X-working field 3,100 mm with reduced machine depth. Safety technology stripe bumper with additional vertical element for reduced distance to the wall.

360° more freedom

Due to the compact design the installation space was reduced by up to 15%.
Additionally, free access to the machine from all sides.



UPS (uninterruptible power supply) (optional)

- Protects the computer against damage in case of mains interruption



Air-conditioning (optional)

- Air-conditioned switch cabinet



ecoPlus – energy saving function

- Simple activation of the stand-by mode
- Vacuum pump is switched off (savings of up to 12%)
- Reduction of compressed air (savings of up to 6%)

Option: Convenience Package

Machine-related handling taken literally. Program start, pausing, relieving the working area and lifting the dust extraction hood can be directly effected by buttons at the gantry housing. This is supplemented by the laser scanner: If the operator is within the scanning zone, the machine is stopped without a program interruption caused by a bumper contact. Simple acknowledgement at the machine is sufficient for further operations.



| | | |
|--|---|--|
| <ul style="list-style-type: none">▪ Switch cabinet integrated into machine▪ Bumper safety technology instead of safety protection mats and protection grids▪ Free positioning of mobile control terminal |  | <ul style="list-style-type: none">▪ More efficient utilisation of space▪ Variable installation opportunities▪ Easy care and cleaning |
|--|---|--|



Linear guiding system Long-lasting linear guiding system with cover and plastic sealings. High-quality protection against dust and dirt. Provides sustainable exactness.

Quality: today for tomorrow

HIGH STANDARDS: You require a suitable basis in order to provide highest performance.

We rely on high-quality and proven components, so that you are perfectly equipped right from the beginning.



Chip transport (optional) Wide chip conveyor integrated in the machine frame for easy disposing of the chips and waste parts

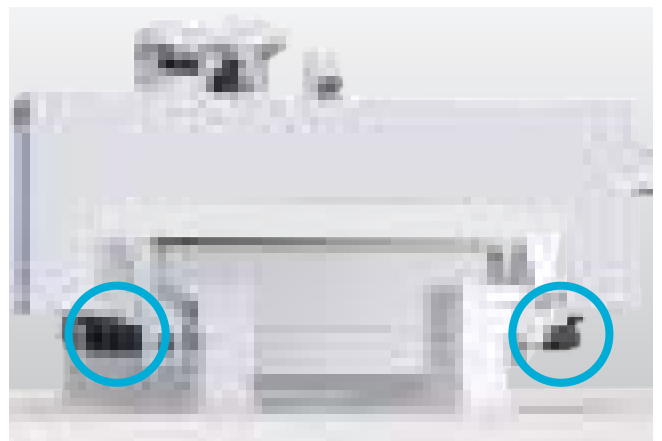

Synchronous drive 2 synchronised digital servo-drives in X-direction guarantee highest precision

Energy efficiency

Effective dust extraction at low extracted volume thanks to optimized capture and removal of chips. Reduced power consumption thanks to stand-by operation of all power components via pushbutton or automatically according to time interval. Reduced compressed air consumption due to optimized pneumatic components.

Suction hood control

Central connection for dust extraction. By moving the slide only the active processing unit is suctioned at a time.

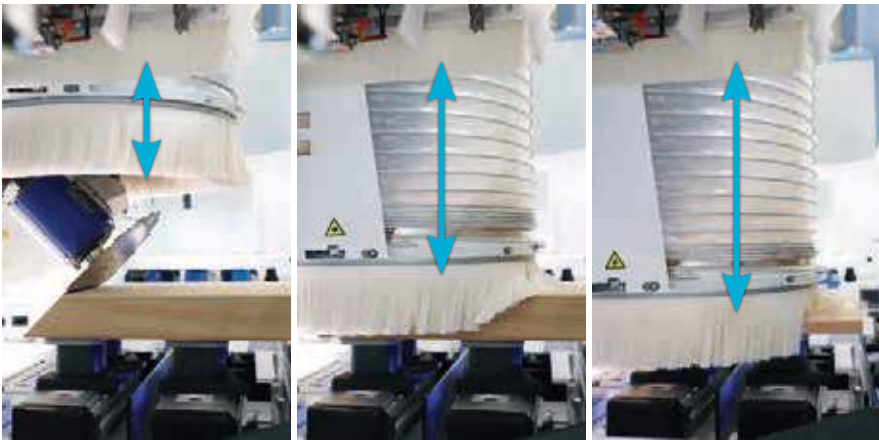

Always in the right position

Effective dust extraction at low extracted volume thanks to optimized capture and removal of chips. The hood can be adjusted in steps or optionally steplessly by motor and automatically adapts to the workpiece thickness.

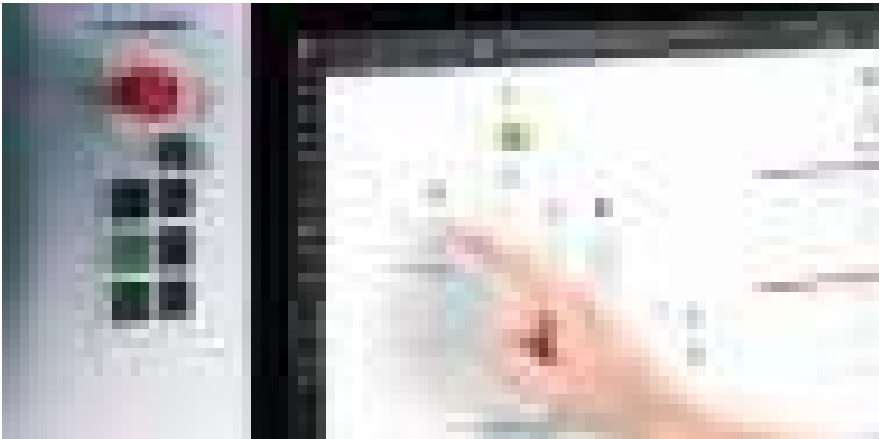

Low-maintenance and controllable vacuum technology

Low-maintenance vacuum pumps ensure consistently high efficiency. By automatically (or manually) switching the pumps on and off, vacuum generation can be adapted to demand.



ecoPlus – energy saving function

- Simple activation of the stand-by mode
- Vacuum pump is switched off (savings of up to 12%)
- Reduction of compressed air (savings of up to 6%)

Whatever you want

Deciding in favour of a HOMAG machine means investing in a highly efficient processing center with the capability to fulfil wide-ranging different manufacturing requirements. Each machine is a complete system guaranteeing maximum output and efficiency every time – no matter how individual your production requirements are.

3- and 4-axis applications

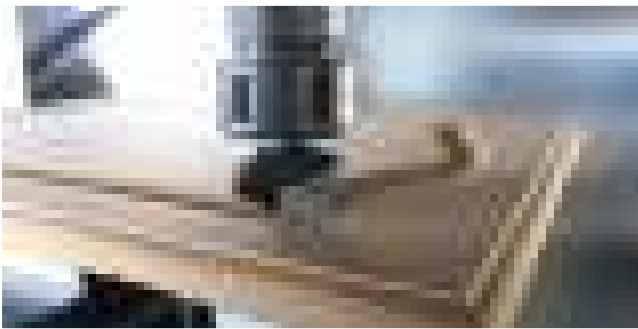

Profiling furniture fronts



Routing lock cases



Cutting mitre cuts



Cutting recesses for connecting fittings

5-axis applications



Mitre cut with high cutting depth for frames



Routing of a dovetail joint for upright / transom constructions



Chamfer trimming on a table top



Square corner routing for a glass rebate



Lock case routing

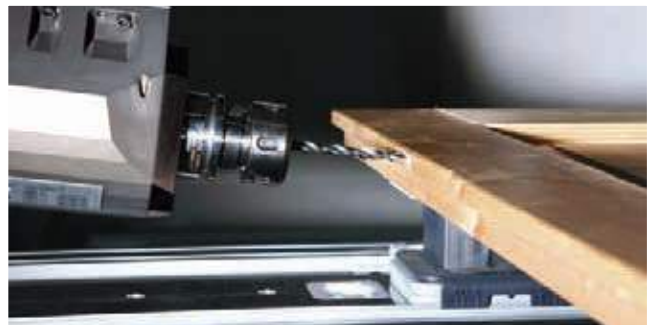

Step drilling for drill-in hinges



Precise, splinter-free miter cuts



Holes for paling at narrow angles

HOMAG drilling technology: The best of the best

High-speed drilling technology, patented clamping of the spindle and quick-change system for tools. Precise drilling, fast cycles, maintenance-free and durable construction.

Additional optional attachments expand the machine's range of applications.

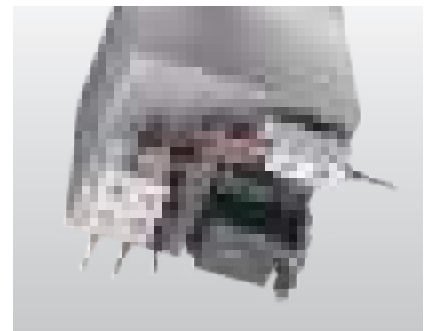

Drilling gear V8/H4X2Y

- 14 drilling spindles [High-Speed 7500]
- 8 vertical drilling spindles
- 4 horizontal drilling spindles in X
- 2 horizontal drilling spindles in Y
- Grooving saw Ø 125 mm (0°)

1 Vertical drilling spindles

3 Grooving saw

2 Horizontal drilling spindles



Drilling gear V12/H4X2Y

- 18 drilling spindles [High-Speed 7500]
- 12 vertical drilling spindles
- 4 horizontal drilling spindles in X
- 2 horizontal drilling spindles in Y
- Grooving saw Ø 125 mm (0° / 90°)



Drilling gear V21/H6X4Y

- 31 drilling spindles [High-Speed 7500]
- 21 vertical drilling spindles
- 6 horizontal drilling spindles in X
- 4 horizontal drilling spindles in Y
- Grooving saw Ø 125 mm (0° / 90°)



Drilling gear V36/H4X2Y

- 42 drilling spindles [High-Speed 7500]
- 36 vertical drilling spindles
- 4 horizontal drilling spindles in X
- 2 horizontal drilling spindles in Y
- Grooving saw Ø 125 mm (0° / 90°)

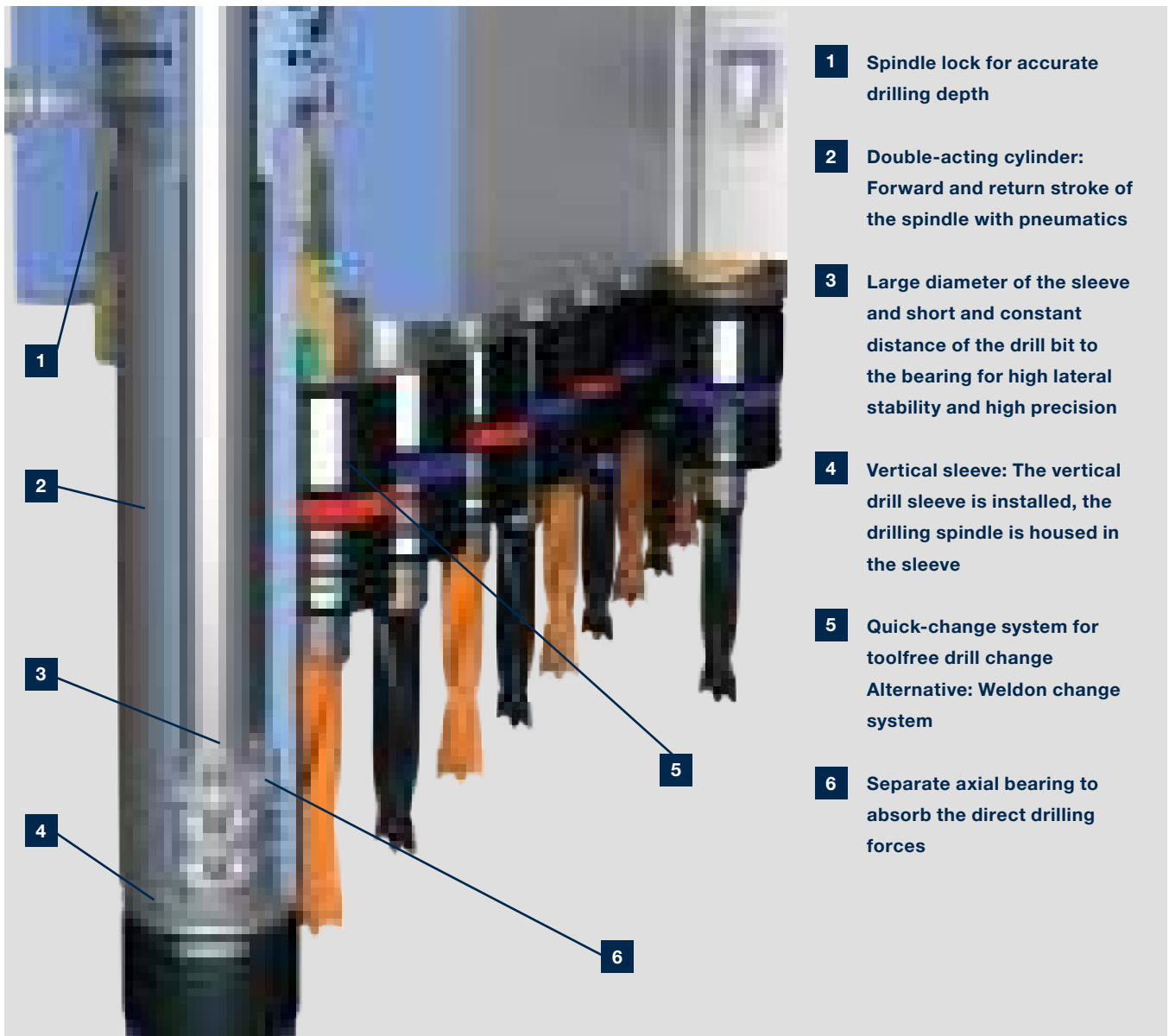

- 1** Spindle lock for accurate drilling depth
- 2** Double-acting cylinder: Forward and return stroke of the spindle with pneumatics
- 3** Large diameter of the sleeve and short and constant distance of the drill bit to the bearing for high lateral stability and high precision
- 4** Vertical sleeve: The vertical drill sleeve is installed, the drilling spindle is housed in the sleeve
- 5** Quick-change system for toolfree drill change
Alternative: Weldon change system
- 6** Separate axial bearing to absorb the direct drilling forces



Weldon change system for a drill change with tools

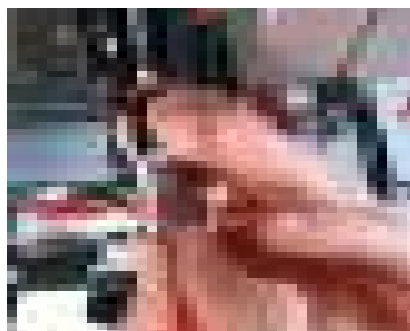

Patented quick-change system for a drill change without tools to reduce setup times.



Automatic spindle lock — patented system for a drilling depth that is always accurate for numerous different materials. With speeds from 1500–7500 rpm for high feed speeds or short drill cycles.

Main spindle technology

We are setting standards with our main spindle technology, increasing the performance and flexibility of our machines. Our highlights are the vibration sensors, which avoid damage to the routing spindles, and the 5-axis technology. Select the spindle suitable for your current and future product range.

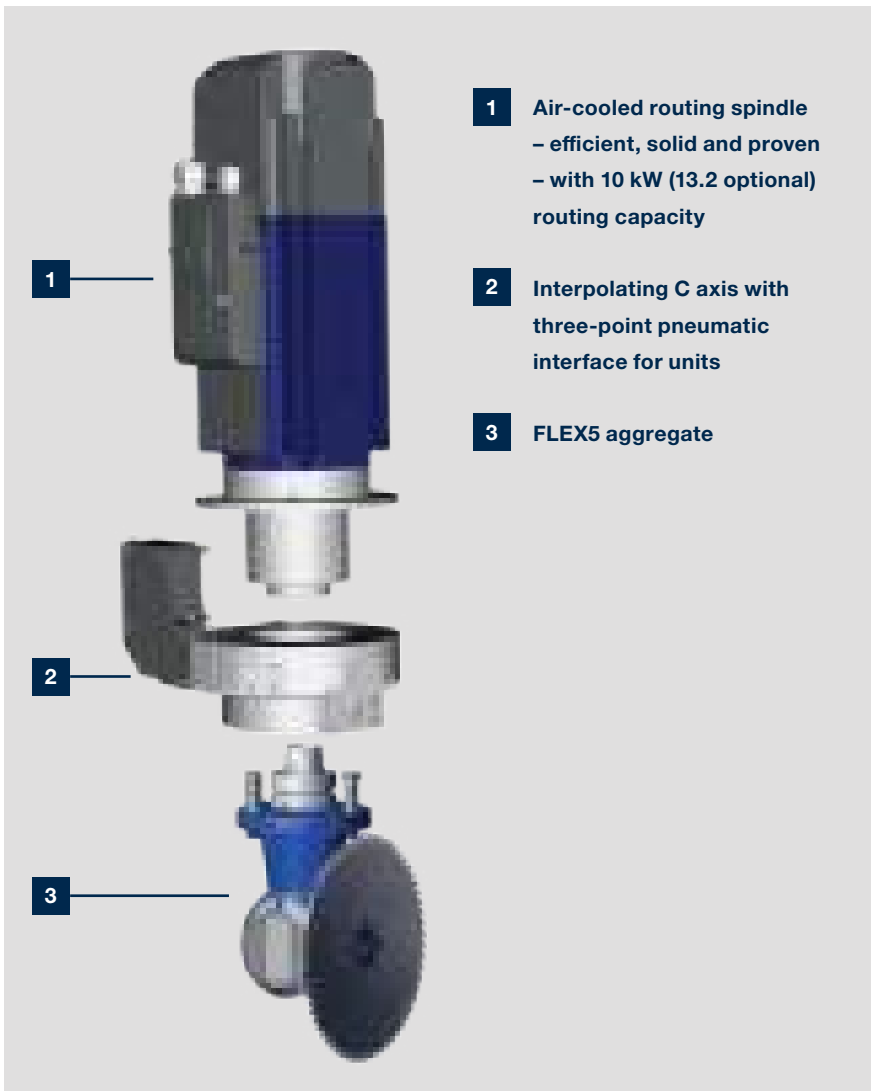

4-axis routing spindle with units interfaces, which open up almost unlimited production opportunities. With patented technologies the range of tasks can be expanded at any time.



Spindle sensor

Routing spindles with hybrid storage offer a long service life. An additional vibration sensor (option) detects tool unbalances and protects the spindle against overloading, due to high feed speeds for example.



Sawing, routing, drilling at any angle
– **FLEX5 aggregate** with automatic angle adjustment. A unique unit for 4-axis spindles, which covers over 90% of 5-axis applications.



The smart DRIVE5CS 5-axis-head – compact design with short power transmission. Comprehensive technology on small space without limits regarding the processing range. Liquid-cooled spindle with 10 kW (as option 12 kW routing capacity) for efficient operations. The short design provides more space for processing (e.g. with a 350 mm saw blade, under the hood).

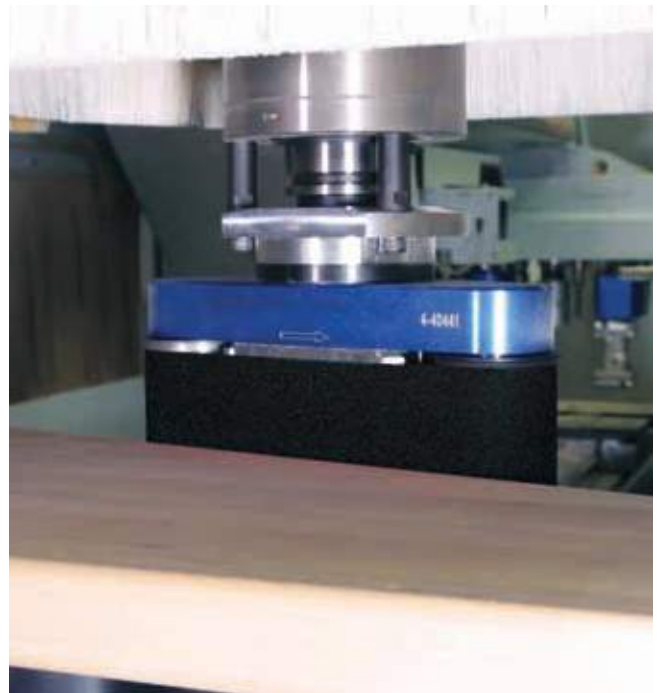

Pneumatic interface – the patented interface with 3-way support on all C-axes and optionally on the DRIVE5CS enables the use of traced units, e.g. for precise rounding off at the top and bottom no matter the thickness tolerances.

Tool changer systems

Simple flexibility

All neatly stored away for quick access. Tool changers provide the basis for the flexible deployment of tools and units, also for large saw blades or heavy processing tools. Right from the beginning you get up to 24 tool changing places.



14-fold tool changer moving in X-direction



8-fold tool changer moving in X-direction





Linear changer

- Additional tool change magazine, with 10 slots and integrated tool transfer station, laterally mounted.
- One slot is prepared to accommodate a saw with a diameter of 350 mm.



Tool length control (optional)

- Suitable for length measurement of shank tools
- Following the tool change via the tool pick-up station a tool length control is carried out and compared with the integrated tool database



Tool pick-up station

- Safe and quick fitting of the tool change magazine
- High safety by sensor monitoring if the tool pick-up station is free or occupied

Options

Aggregates for 4-axis equipment

Range of modular units for flexible working

The aggregates required for the respective processing steps are fully automatically changed from the tool changing system into the main spindle of the machine. They can be swivelled from 0 to 360° over the C-axis. You get a great deal of flexibility and thus sufficient room to implement your own ideas. Always the optimal solution for your specific tasks.

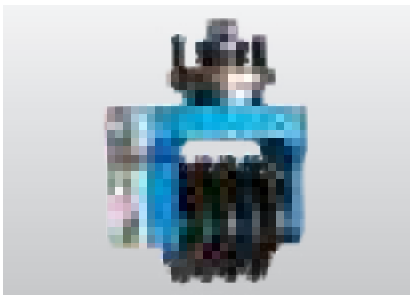

High Performance
Planing*



Drilling/Sawing, swivelling*,
(0° - 90°)



High Performance
Drilling/Sawing/Routing*, 2 spindles

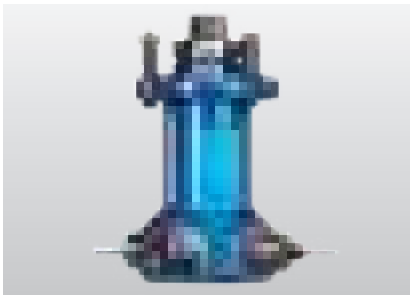

Drilling/Routing*,
4 spindles



Cam box router*,
2 spindles



Extension to FLEX5 (for 4-axis version)
Consisting of FLEX5 interface and FLEX5 head



Tracing routing aggregate with tracing ring*



Cutting aggregate*

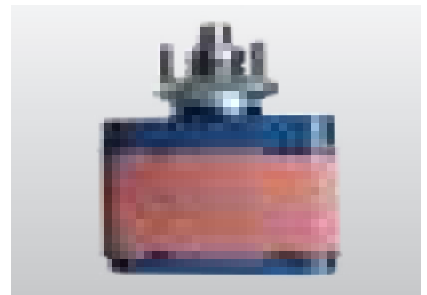

Belt sanding unit

* For maximum tool lengths and diameters see the respective technical data sheet



Many aggregates are optionally available as High Performance versions. This ensures optimum lubrication of gear components for prolonged operations.

Clean and fast: the console table

The classic table with single-circuit vacuum system.

The vacuum clamps are steplessly positioned and offer clearance for the use of tools and for dropping waste pieces.

As standard, the exact positioning is supported by measuring tapes. LED and laser positioning aids are provided for fast and easy positioning of suction cups.



Measuring tape for positioning of suction cups

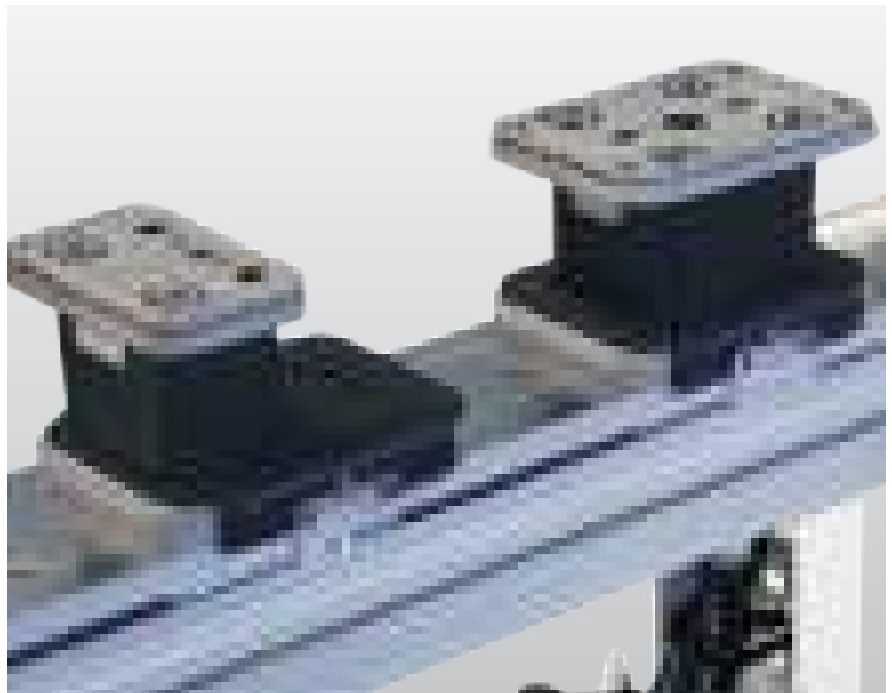

LED positioning system (optional) LED lights show the operator exactly the position, orientation and size of the suction cups as well as the position of the consoles → positioning faster by 70 %



Laser positioning (optional) Simple positioning of the vacuum cups through the pin laser. The workpiece contour can be "moved" as a positioning aid for free-formed workpieces.



Laser projection of the clamping equipment and the workpiece contour for optimal utilization and simple positioning of unprocessed parts that cannot be aligned on the stops.



Suction cup storage area Storage area laterally integrated into the machine for vacuum suction cups for easy and fast access

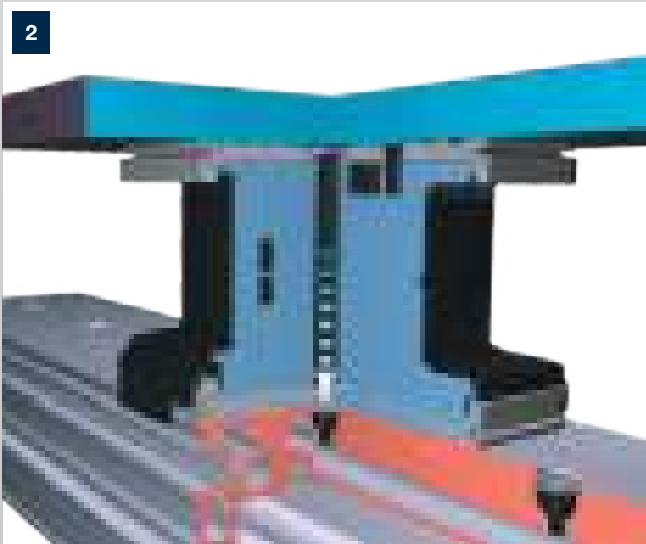

In the single-circuit vacuum system vacuum clamps are used with a height of 100 mm. The vacuum clamps the workpiece and clamp simultaneously. The lip technology of the rubber-coated surfaces on the vacuum clamps guarantees maximum force distribution. The double lip technology on the underside of the vacuum clamp allows stepless positioning on the consoles.

Accurate and safe with the console table

Thanks to the patented system of solenoid valves, vacuum suction units and other clamping equipment can be used in any number and in any location on the consoles. Application-optimized stops and insertion aids ensure precise placement and positioning of the components.



Workpiece feeding rail Solid feeding rails to ease placing of heavy workpieces with 2 pneumatic cylinders. The linear movement of the feeding rails ensures safe positioning of the workpieces, regardless of whether they are processed at the front or rear stops.



Electronic cylinder surveillance
Improved safety by electronic surveillance of all stop cylinders



Stop system (rear, front and side) Solid stop bolts pneumatically lowerable and incl. electronic cylinder surveillance

Stops for coating ply overhang (optional) Ensures easy positioning in the case of coating ply overhang (e.g. veneer)

PowerClamp E.g. for processing of solid wood components on 6 sides (lowerable base plate)

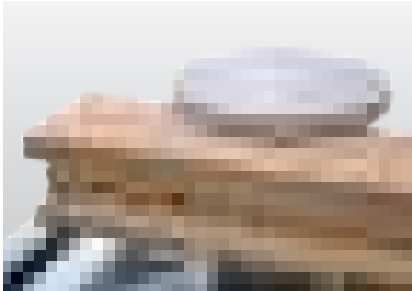

Clamping device Uprights and staves can be securely clamped in no time using this clamping device

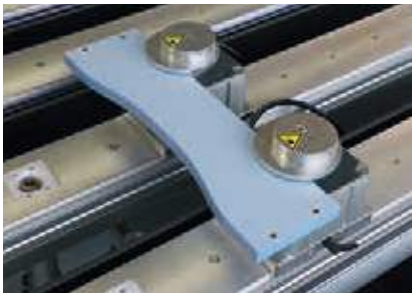

Multi clamping system E. g. for frames and small parts

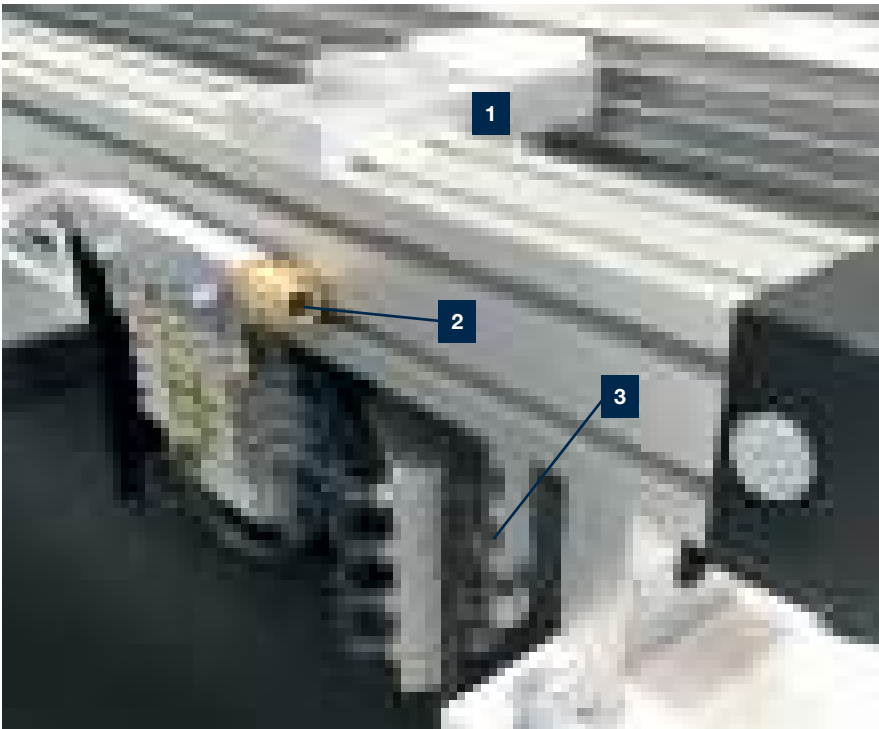

Base plate module for mounting on the consoles as the basis for special clamping fixtures.

- 1** Easy adjustment of the side stops
- 2** Vacuum connection for templates
- 3** Pneumatic connection with 2-pressure control for 2 clamping rows (optional)

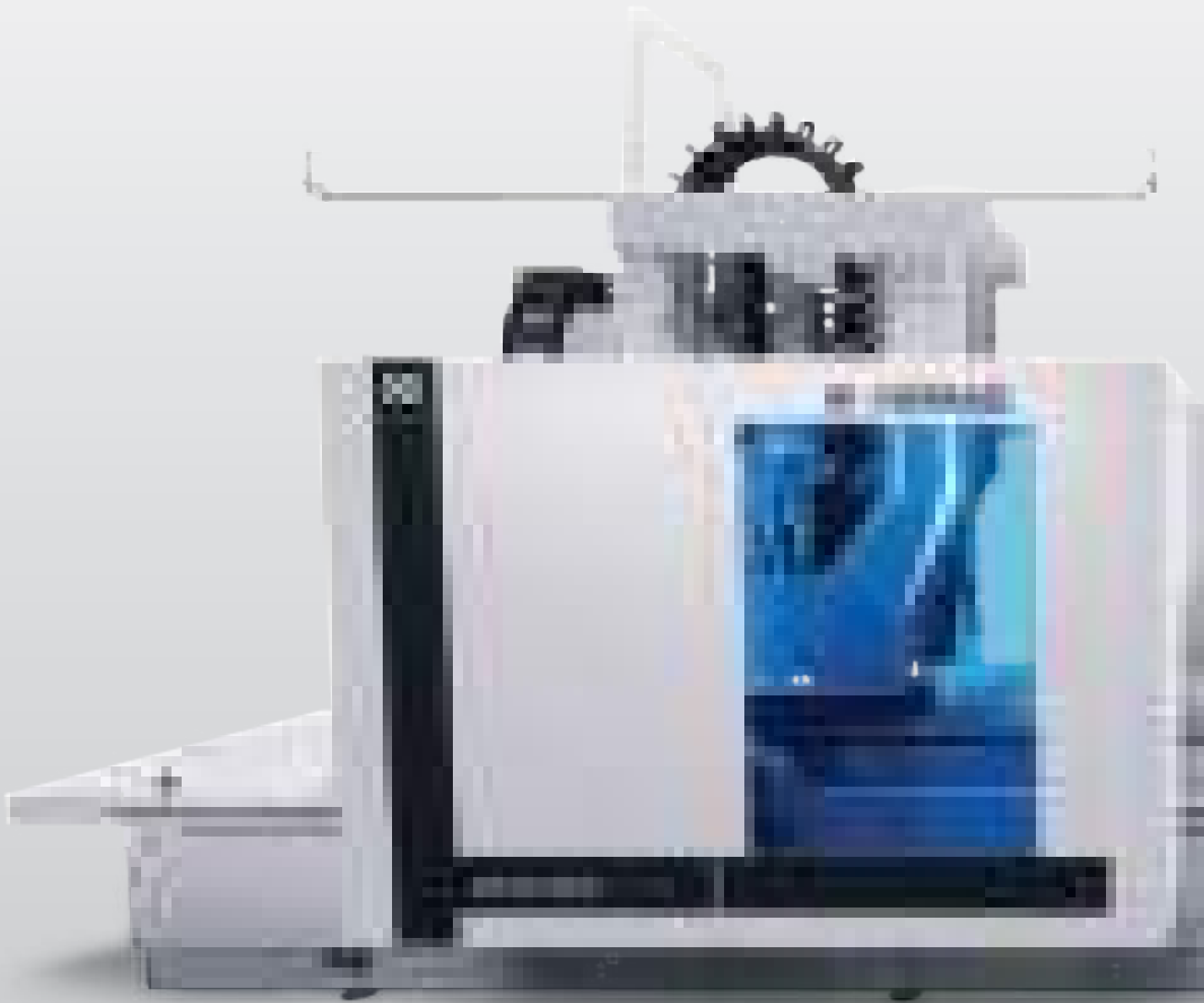

1" vacuum connections with quick-open function by means of switch cabinet key, vacuum openings with precision thread for fixing clamps



Slot nuts with thread for positive locking of clamping fixtures in the dovetail guide.



Aluminium matrix table with trapeze shaped grooves for interlocking and flexible fixing of all kinds of clamping aids

Versatile application: the matrix table

The grooved aluminium matrix table permits the positive locking of clamping elements and consequently reliable workpiece fixture even where high hogging forces are involved. The transmission of vacuum through the table construction optimizes distribution of the vacuum, reduces

leaks and transmission losses and does away with the need for complex installations. The matrix table is also suitable for aggregates due to different clamping elements with variable mounting heights.



Laser positioning Routing contours can be processed via the cross-laser

The Matrix table – for Nesting and many other applications



Vacuum clamp Vacuum clamping elements for insertion in the grooves of the Matrix table

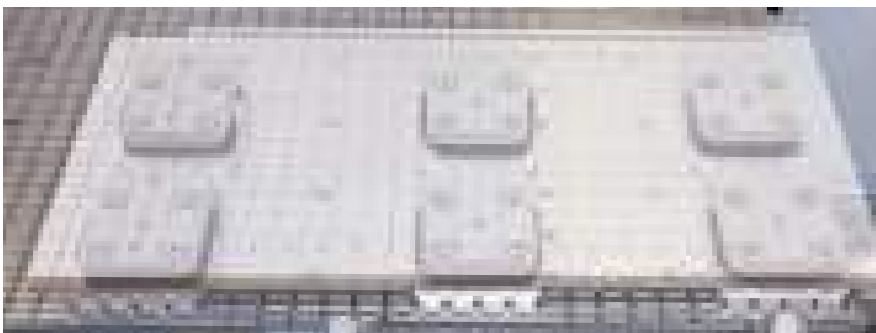
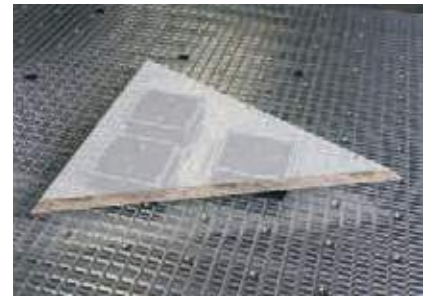

Maxi-Flex system Freely mountable system base plate for vacuum clamp.

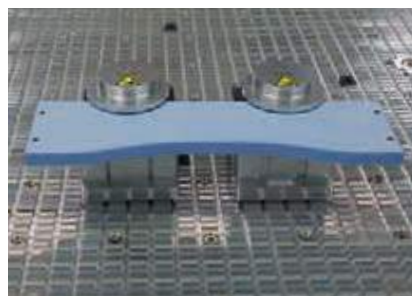

Multi-clamp Vacuum-actuated clamping element for clamping strips and elements.



Fixture using non-standard clamps The aluminium Matrix table with dovetail guides guarantees precise, positive fitting clamping element fixture.

With diverse types of vacuum blocks with different heights it is possible to carry out simple and quick horizontal processing on Matrix tables, e.g. for doors. And when processing technical components and moulded parts, it is also possible to partly dispense with clamping templates.

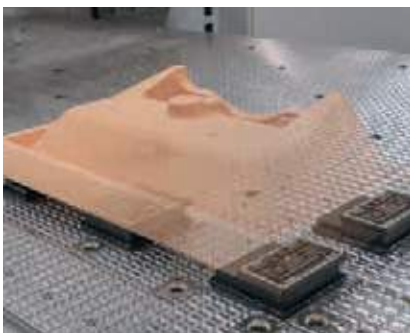

Nesting processing of panel materials: waste-optimized cutting to size and processing in the surface

HOMAG software solutions

The basis for simple and efficient operation

Our processing centers are one thing – the software to operate them conveniently and easily day-to-day is another. HOMAG software and control modules ensure maximum flexibility and operational safety. Naturally with HOMAG:

Interfaces to external programming and construction systems, auxiliary programs for nesting and modules for machine monitoring and performance tracking.

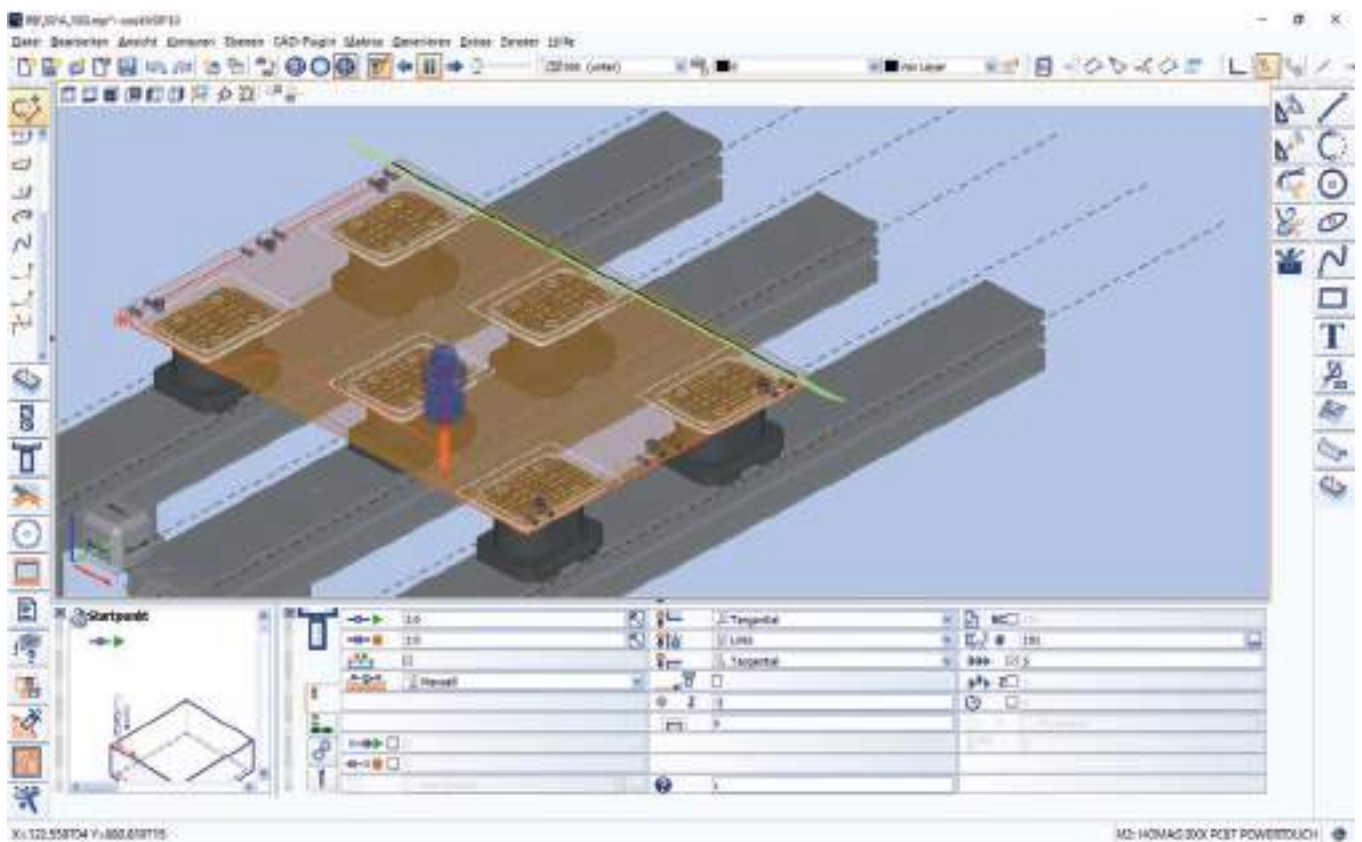

woodWOP – efficient thanks to fast programming

- Fast and intuitive operation thanks to simple, direct navigation
- Select from a choice of variables for flexible variable programming
- Quickly create individual subprograms
- Increased programming security through 3D images of workpieces, processing and clamping equipment
- Very easy to use through infinitely adjustable windows, multi-screen capability, language-neutral input screens, help images, etc.
- The largest online forum for CNC programming is: forum.homag.com



More information
you find on our website in the brochure
»Software from the HOMAG«

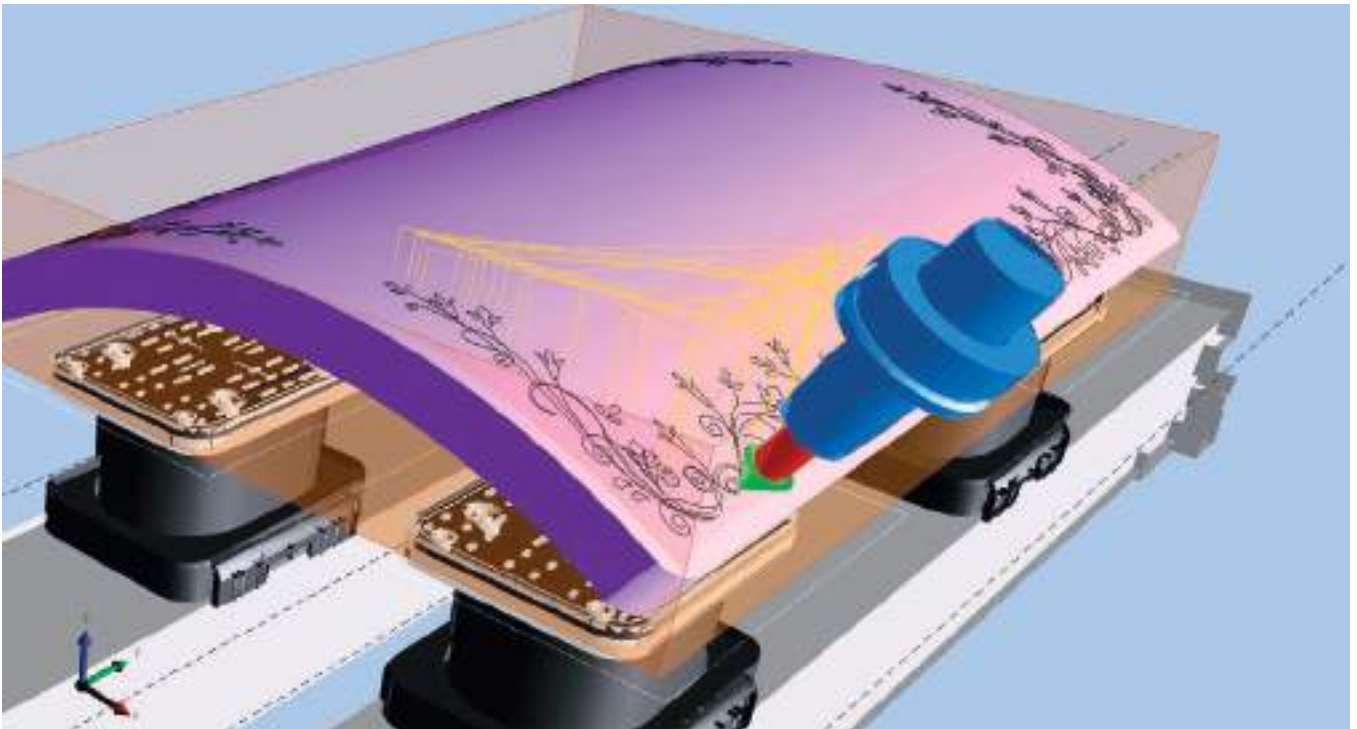

woodWOP CAM-Plugin

- CAD/CAM functions directly integrated into woodWOP
- Easy and fast import of 3D models or creation of 3D surfaces via integrated CAD plugin
- Automatic generation of the milling paths for roughing, finishing and formatting 3D objects
- Safe work, because the milling paths and the overrun movements are displayed graphically and simulated in woodWOP

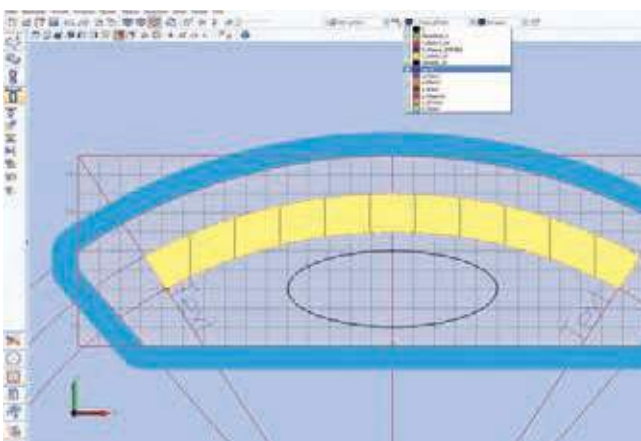

woodWOP CAD-Plugin

- CAD functions integrated directly into woodWOP
- Creation of your own CAD drawings on the machine and the work preparation station
- Import of CAD objects in the formats DXF, IGS, STP, STL

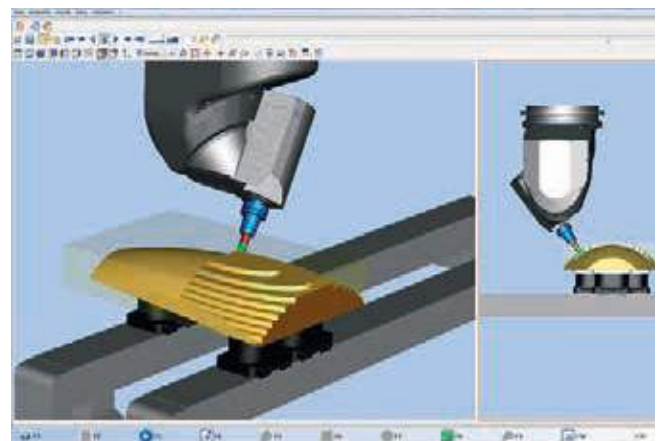

woodMotion – processing simulation of programs

- Optimal program preparation as running-in periods on the machine are reduced
- Simulation of 5-axis processing including material removal
- Display of the actual processing times and collision monitoring between tool and clamping elements
- Simulation based on a virtual 1:1 image of the machine configuration gives a very accurate picture of the real processing



powerTouch PC87 with full touch operation

- 3D view of the machine bed, consoles, suction unit and workpiece
- Simple assignment using drag & drop
- Saving and loading of complete assignment situations
- Automatic location-specific suction unit recommendation with selectable suction unit types
- Manual clamping equipment positioning using touch under consideration of all travel areas



Slot assignment

- Can be operated completely by touch
- Simple assignment using drag & drop
- Preview of the woodWOP programs as a miniature view
- Assignment of parts with different thicknesses
- Saving and loading of complete assignment situations
- 3D view can be freely rotated
- 3D representation of machine bed, consoles, stop cylinders, suction unit and clamp, workpiece and processing

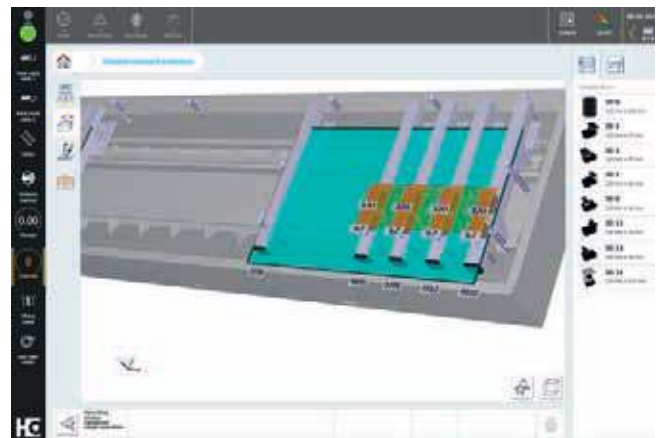

Automatic suction unit recommendation for workpiece or entire table

- Suction unit recommendation with preselection of suction unit types
- Processing tracks as an aid for positioning clamping equipment
- Manual clamping equipment positioning using touch under consideration of all travel areas
- Check of suction units already included in the woodWOP program
- Warning when suction units are not in the correct position

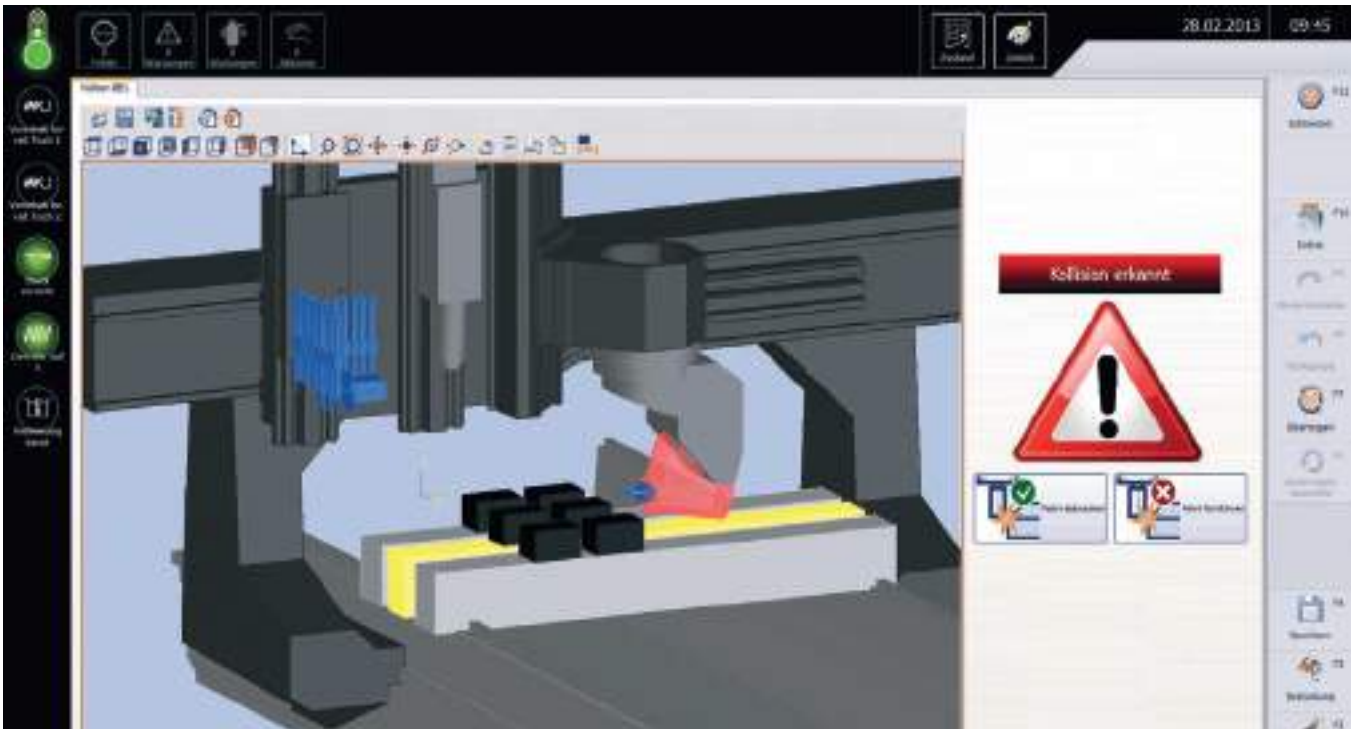

collisionControl – permanent security for your machine

- Monitors for potential collisions between machine components and clamping equipment during processing
- The machine stops automatically in the event of an imminent crash situation
- The crash situation is displayed as a snapshot with colored collision bodies
- The machine is displayed as an active 3D model in live mode



woodScout – help in your language

- Optional powerful diagnostic system
- Graphic display of the malfunction location on the machine
- Clear plain-text error messages in different languages
- Adaptive system through the allocation of causes and measures



Graphic tool data base

- Record quantities and actual operating times on the machine
- 3D representation of the tools and units
- Graphic setup of the tool changer using drag & drop



Machine data acquisition MMR – for a productive environment

- Record quantities and actual operating times on the machine
- Integrated maintenance instructions for optimum time and quantity-based planning, as well as performing maintenance
- Optional professional version allows detailed breakdown and logging of the recorded data

VALYOU

Our Mission, Your Performance.

Fast support:

94% resolution rate
via our hotline

Close to you:

1,350 service experts worldwide

We get things moving:

Over 1,000 worldwide spare parts
shipments each day

No one else has that:

Electronic documentation on over
150,000 machines, available in 28
languages

LIFE CYCLE SERVICES

Improved performance, more efficient processes, faster help, assurance of availability and smarter working.

VAL YOU comes from VALUE ADDED. Our objective is derived from this name: We create added value for your business by helping you get the most out of your processes. Every day.

Apps and digital assistants.

Quick and easy support in your machine environment.

Some people still use pen and paper to create their cutting patterns. But they look at their smartphone if they want to know what the weather is like – instead of looking out of the window. We asked ourselves: why not combine the best of both? Our apps and digital solutions make your everyday work easier: machines, material, tools, cutting patterns, components – you always have everything in your pocket or on your desk.



More information at digital.homag.com





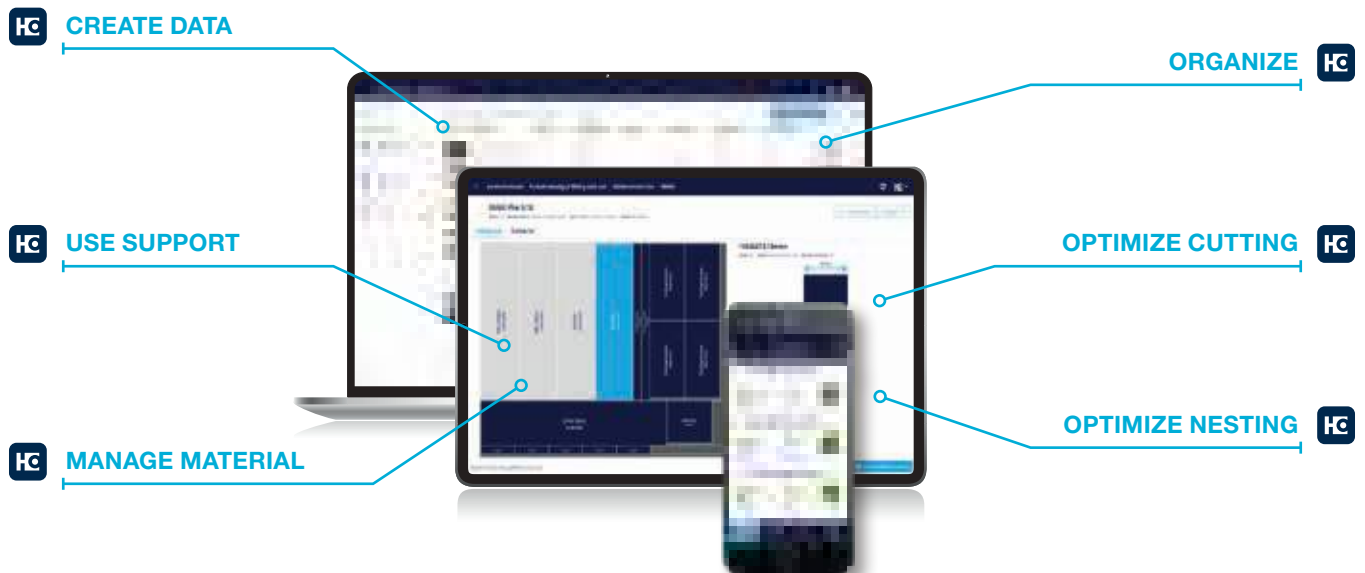

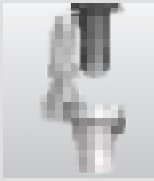

WE HAVE DEVELOPED POWERFUL AND SMART SOLUTIONS FOR YOU:

- ✓ Always low investment
- ✓ Always up to date (no updates necessary)
- ✓ Always easy to use (no complex software)
- ✓ Always helpful

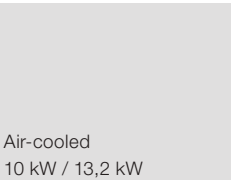

Summary: Configurations

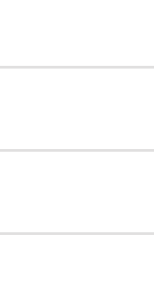
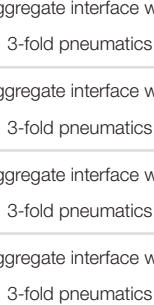
It's your choice. One package available for all current demands. Thus, all requirements are fulfilled.

| | | Spindel | C-axis | Interface Option | Tool changer tool changer | | | | |
|--|----------|---|---|---|---|--|---|---|---------|
| 3-/4-axis = Z 240 mm (1 Z-axis) | Classic |  |  |  |  | | | | |
| | Advanced | | | | | Air-cooled 10 kW / 13,2 kW | ○ | FLEX5 | 8-fold |
| 3-/4-axis = Z 260 mm (2 Z-axes) | Classic |  |  |  |  | | | | |
| | Advanced | | | | | Air-cooled 10 kW / 13,2 kW | ○ | FLEX5 | 8-fold |
| | Premium | | | | | Air-cooled 10 kW / 13,2 kW | ○ | FLEX5 | 14-fach |
| | Solid | | | | | Air-cooled 10 kW / 13,2 kW | ○ | FLEX5 | 14-fold |
| 5-axis = Z 260 mm (2 Z-axes) | Classic |  |  |  |  | | | | |
| | Advanced | | | | | DRIVE5CS Liquid-cooled 10 kW / 12 kW | ○ | Aggregate interface with 3-fold pneumatics | 8-fold |
| | Premium | | | | | DRIVE5CS Liquid-cooled 10 kW / 12 kW | ○ | Aggregate interface with 3-fold pneumatics | 8-fold |
| | Solid | | | | | DRIVE5CS Liquid-cooled 10 kW / 12 kW | ○ | Aggregate interface with 3-fold pneumatics | 14-fold |

- Classic** Universal basic configuration for furniture components and structural elements.
- Advanced** Increased performance in panel processing thanks to more drilling spindles.
- Performance** Fast drilling and universal application with high tool variation.
- Solid** Compact drilling gear and large changer. Ideal for all applications with a focus on routing with high tool variety.



| 10-fold linear changer | Drilling gear | | | | Grooving |
|---|--|-----------------|-----------------|--|----------|
| | Drilling [7500 High-Speed] | | | D125 | |
| | vertical | horizontal in X | horizontal in Y | | |
|  |  | | |  | |
| ✓ | V12 (V8) | 4 | 2 | 0°/90° (0°) | |
| ✓ | V21 | 6 | 4 | 0°/90° | |
| ✓ | V12 | 4 | 2 | 0°/90° | |
| ✓ | V21 (V36) | 6 (4) | 4 (2) | 0°/90° | |
| ✓ | V21 (V36) | 6 (4) | 4 (2) | 0°/90° | |
| ✓ | V12 | 4 | 2 | 0°/90° | |
| ✓ | V12 | 4 | 2 | 0°/90° | |
| ✓ | V21 (V36) | 6 (4) | 4 (2) | 0°/90° | |
| ✓ | V21 (V36) | 6 (4) | 4 (2) | 0°/90° | |
| ✓ | V12 | 4 | 2 | 0°/90° | |

Standard: ✓

Option: ○

Alternatively: ()



WORKING DIMENSIONS

| Y = Workpiece width [mm/inch] | A = 0° with tool diameter 25 mm | A = 90° with tool length 200 mm / with all aggregates | Drilling / Loadable workpiece |
|-------------------------------|---------------------------------|---|-------------------------------|
| | Rear stop | Rear stop | Rear stop |
| 1 Z-axis (Z = 240 mm) | 1,550 / 61,0 | 1,440 / 56,7 | 1,600 / 63,0 |
| 2 Z-axes (Z = 260 mm) | 1,415 / 55,7 | 1,210 / 47,6 | 1,600 / 63,0 |

| X = Workpiece length [mm/inch] | A = 90° with tool length 195 mm /with all aggregates | |
|--------------------------------|--|------------------------|
| | Individual processing | Alternating processing |
| /31 | 3,100 / 122,0 | 1,025 / 40,4 |
| /42 | 4,200 / 165,4 | 1,575 / 62,0 |

| Z = Workpiece thickness [mm/inch] | from console |
|-----------------------------------|--------------|
| 1 Z-axis | 240 / 9,4 |
| 2 Z-axes | 260 / 10,2 |

INSTALLATION DIMENSIONS

| Machine type | | Installation length [mm/inch] | Installation depth [mm/inch] | | | Installation height [mm/inch] |
|-----------------------|-----|-------------------------------|------------------------------|-----------------------------|----------------------------|-------------------------------|
| | | | L | W with 14-fold tool changer | W with 8-fold tool changer | |
| 1 Z-axis (Z = 240 mm) | /31 | 6,850 / 269,7 | – | 3,472 / 136,7 | – | 2,408 / 94,8 |
| | /42 | 7,950 / 313,0 | – | 3,472 / 136,7 | – | 2,408 / 94,8 |
| 2 Z-axes (Z = 260 mm) | /31 | 6,850 / 269,7 | 3,615 / 142,3 | 3,616 / 142,4 | 3,048 / 120,0 | 2,655 / 104,5 |
| | /42 | 7,950 / 313,0 | 3,615 / 142,3 | 3,616 / 142,4 | 3,048 / 120,0 | 2,655 / 104,5 |

CONSOLE TABLE

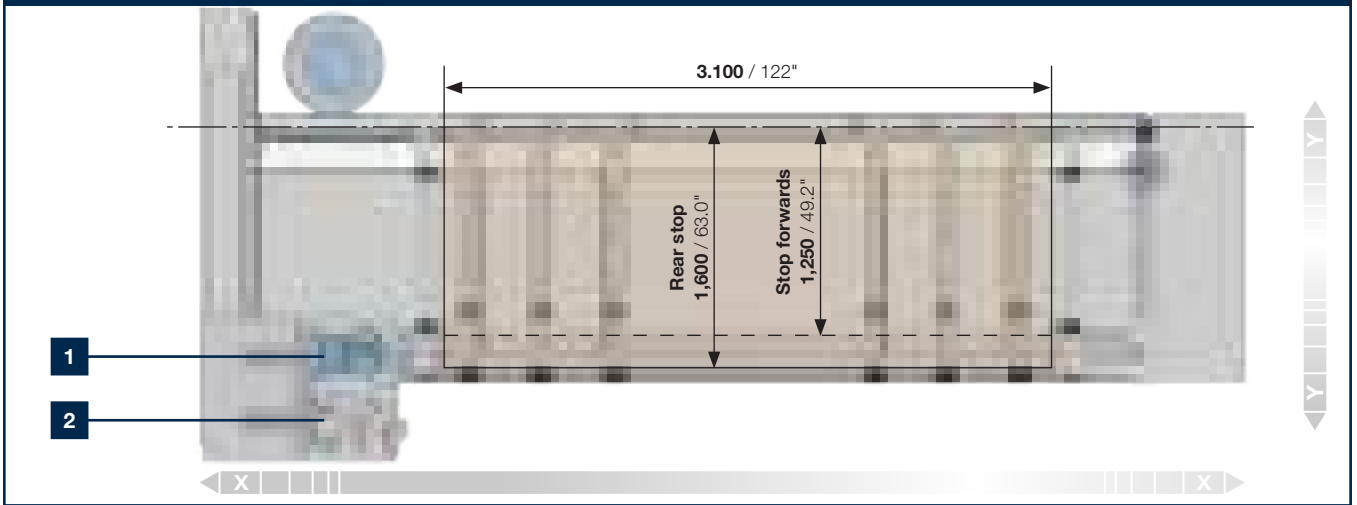

MATRIX TABLE

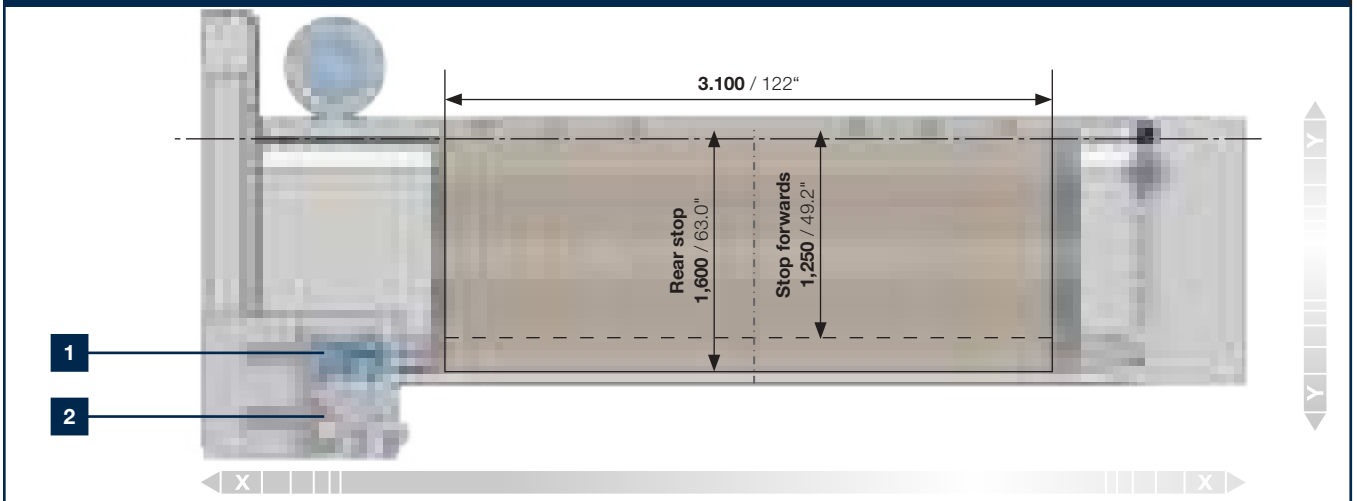

1 Routing spindle

2 Drilling gear

mm / inch



HOMAG Group AG

info@homag.com
www.homag.com

YOUR SOLUTION