



ARTOS SLAT83

THERMAL INSULATED SLIDING SYSTEM
ISI YALITIMLI SÜRME SİSTEMİ

Artos SLAT 83, which has 16 mm thermal insulation, can produce opening solutions up to 8 wings with alternative frame profiles. SLAT 83 stands out with its profile design in multi-point locking enclosures. Suitable for productions at a maximum height of 2.5 meters, SLAT 83 has a carrying capacity of up to 150 kg with its bendable bearing and steel rail. It provides extra comfort with special corner details and elegant mosquito net details that facilitate production.

16 mm ısı bariyerine sahip olan Artos SLAT 83, alternatif kasa profilleri ile 8 kanata kadar açılım çözümleri üretebilmektedir. SLAT 83, çok noktalı kilitleme kabiliyetindeki profil tasarımı ile dikkat çeker. Maksimum 2.5 metre yükseklikteki üretimler için uygun olan SLAT 83, ayarlanabilir rulman ve çelik ray ile 150 kg'a kadar taşıma gücüne sahiptir. İmalatı kolaylaştıran özel köşe bağlantıları ve zarif sineklik detaylarıyla ekstra konfor sağlar.



ARTOS SLAT83

THERMAL INSULATED SLIDING SYSTEM
ISI YALITIMLI SÜRME SİSTEMİ



Frame Profile External Height

Double-Rail Frame (mm)	83 mm
Three-Rail Frame (mm)	127 mm

Clamping Profile External View

Clamping Front View	76,6 mm
---------------------	---------

Dimension Limits

Maximum Vent Weight	75 kg
Maximum Vent Height (H)	240 cm
Maximum Vent Width (W)	110 cm

Glazing Range

Minimum Glass Thickness	20 mm
Maximum Glass Thickness	22 mm

Profile Wall Thickness

Maximum Profile Wall Thickness	1,3 mm
--------------------------------	--------

Glazing Method

EPDM Gasket	✓
-------------	---

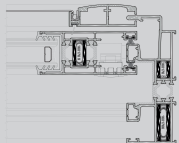
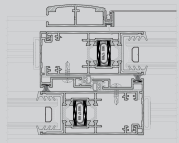
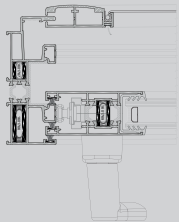
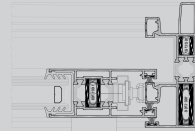
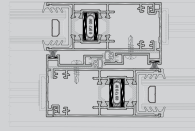
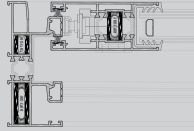
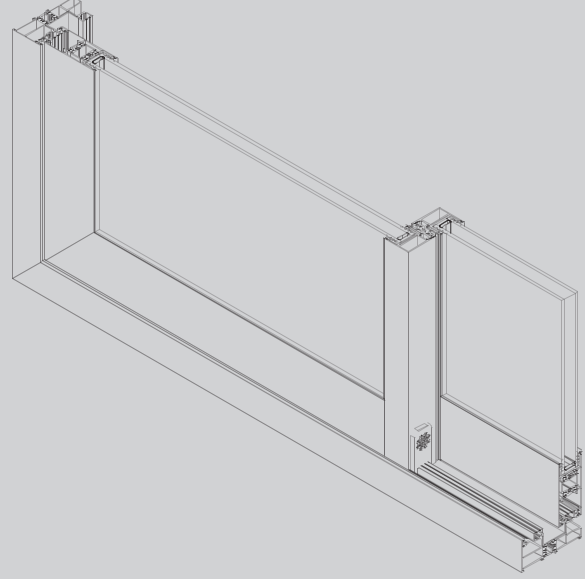

AÇILIM TİPİNG TİPES

