

LET IT FLOW

quicker, cooler, faster...



flosense® 4.0

DIGITAL FLOW MONITOR

flo_sense® 4.0

MANIFOLD



Complete unit with Pressure sensor installed on main inlet / return.

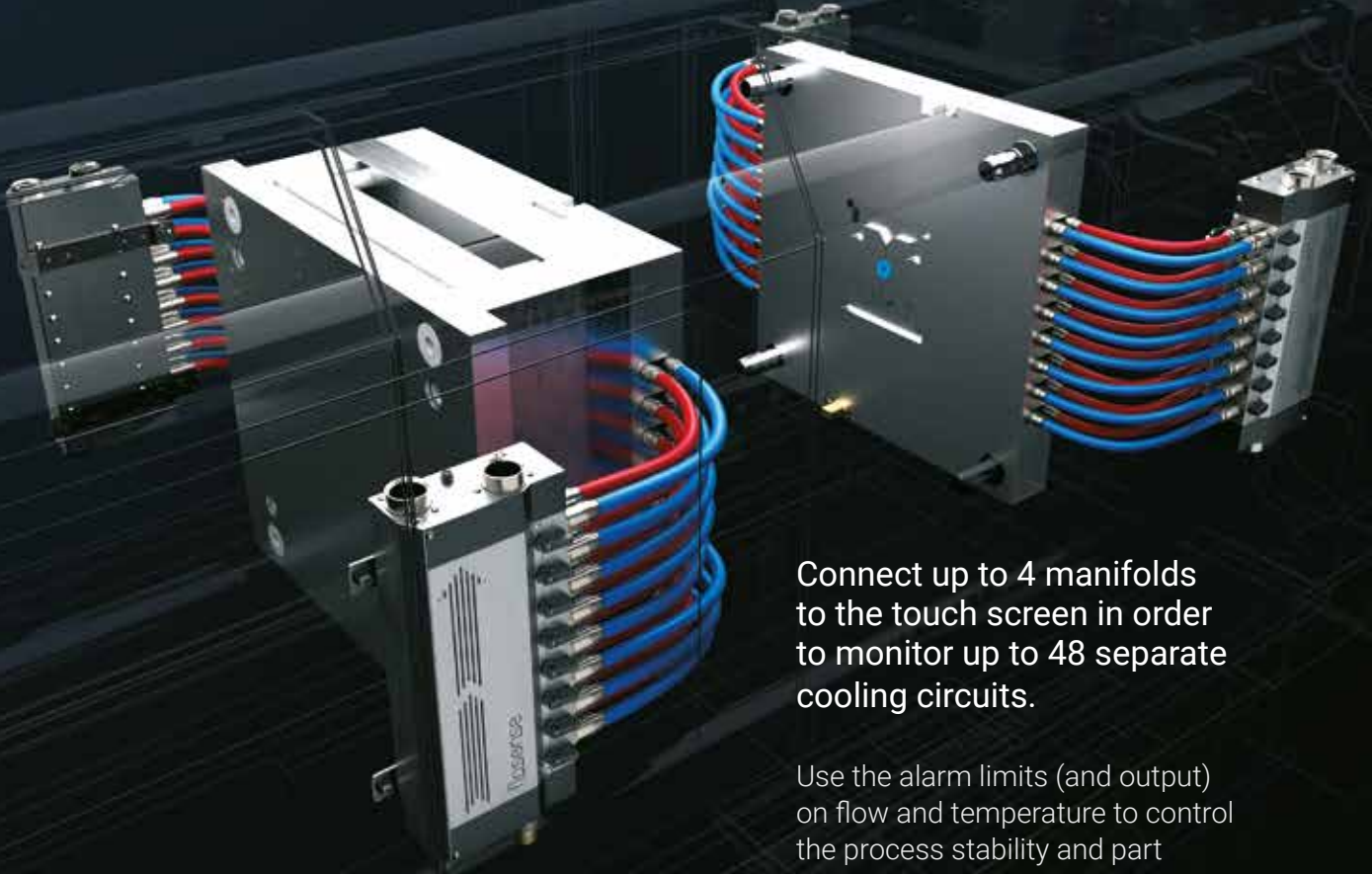

Connect up to 4 manifolds to the touch screen in order to monitor up to 48 separate cooling circuits.

Use the alarm limits (and output) on flow and temperature to control the process stability and part quality.



Upgrade your moulding machine with new digital flow manifold and improve your productivity.

Replacing traditional analogue manual flow regulators with new digital flow manifold will give you many advantages such as:

- Digital monitoring of Flow, Temperature and Pressure
- Alarm Output
- Higher flow capacity
- Higher temperature range
- Data storage and export
- Faster Mould changeovers
- OPC-UA / Euromap interface /

Touch Screen with 4 manifold inputs. With magnetic bracket for easy installation.

Equipped with power, alarm, USB and Ethernet connections.

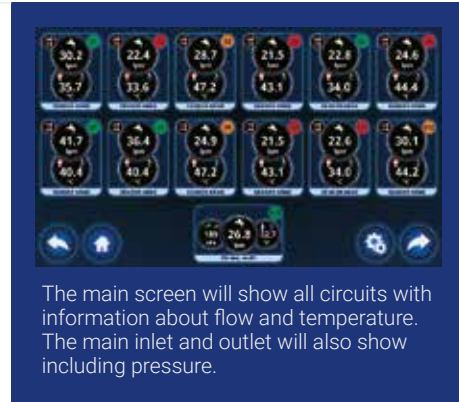

The main screen will show all circuits with information about flow and temperature. The main inlet and outlet will also show including pressure.



Data is stored in the internal memory and can be displayed in graphical view for each circuit. Data can also be exported for external use.



By clicking on a specific circuit you will see detailed information, including delta T (heat transfer) of the specific channel. Also, turbulent flow indicator is included.



The system is equipped with Audit Log to keep track of all events including user ID tracer.

PART NO.	Size	Manifold inputs	Power Connection	Alarm Output	Interface
FS-7100	7,1"	4	12V	Yes	OPC-UA

CONSTRUCTION

Material:

Flow modules: DZR Brass / nickel plated /
Cover: stainless steel

PART NO.	Flow sensor range option (l/m)			Ports	Length / mm /	Width / mm /	Height / mm /	
	0,5-10	1-20	2-40					
F4M4-x-xx	•	•	•	4	220	155	72	120°C
F4M4HT-x-xx	•	•	•	4	220	155	72	160°C
F4M6-x-xx	•	•	•	6	287	155	72	120°C
F4M6HT-x-xx	•	•	•	6	287	155	72	160°C
F4M8-x-xx	•	•	•	8	354	155	72	120°C
F4M8HT-x-xx	•	•	•	8	354	155	72	160°C
F4M10-x-xx	•	•	•	10	421	155	72	120°C
F4M10HT-x-xx	•	•	•	10	421	155	72	160°C
F4M12-x-xx	•	•	•	12	488	155	72	120°C
F4M12HT-x-xx	•	•	•	12	488	155	72	160°C

Ordering Example: Part No. + Flow sensor range (F4M4-1-20)

HT = High Temperature.

Complete unit with Pressure sensor installed on main inlet / return. Connect up to 4 manifolds to the touch screen in order to monitor up to 48 separate cooling circuits.
Use the alarm limits (and output) on flow and temperature to control the process stability and part quality.

Material:

Flow modules: DZR Brass / nickel plated / Cover: stainless steel.

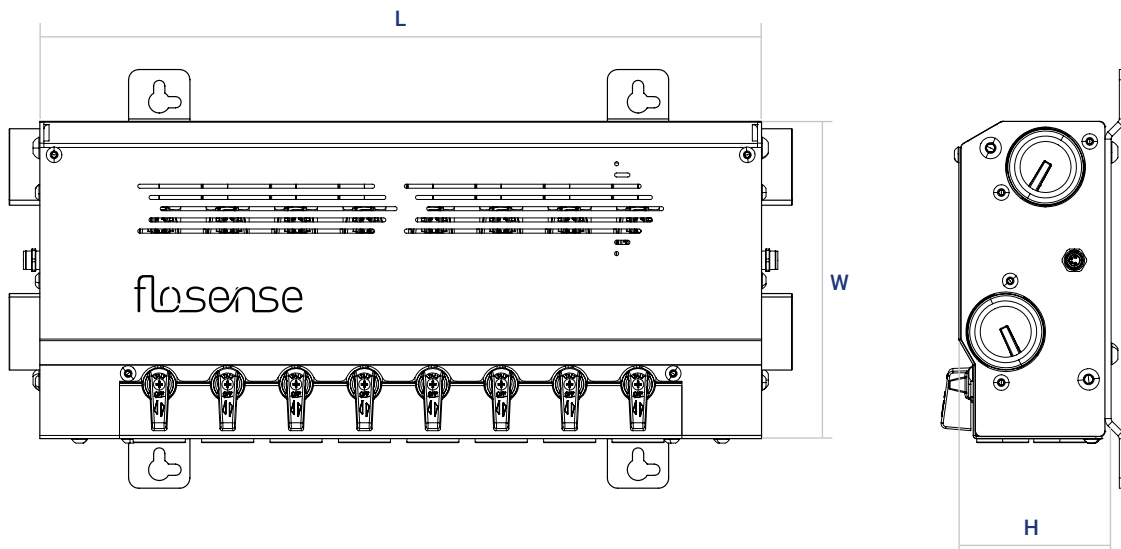

- 01 / Dual Port Ball Valve
- 02 / Top Cover
- 03 / Individual Flow Module
- 04 / Front Cover
- 05 / Flow Circuit

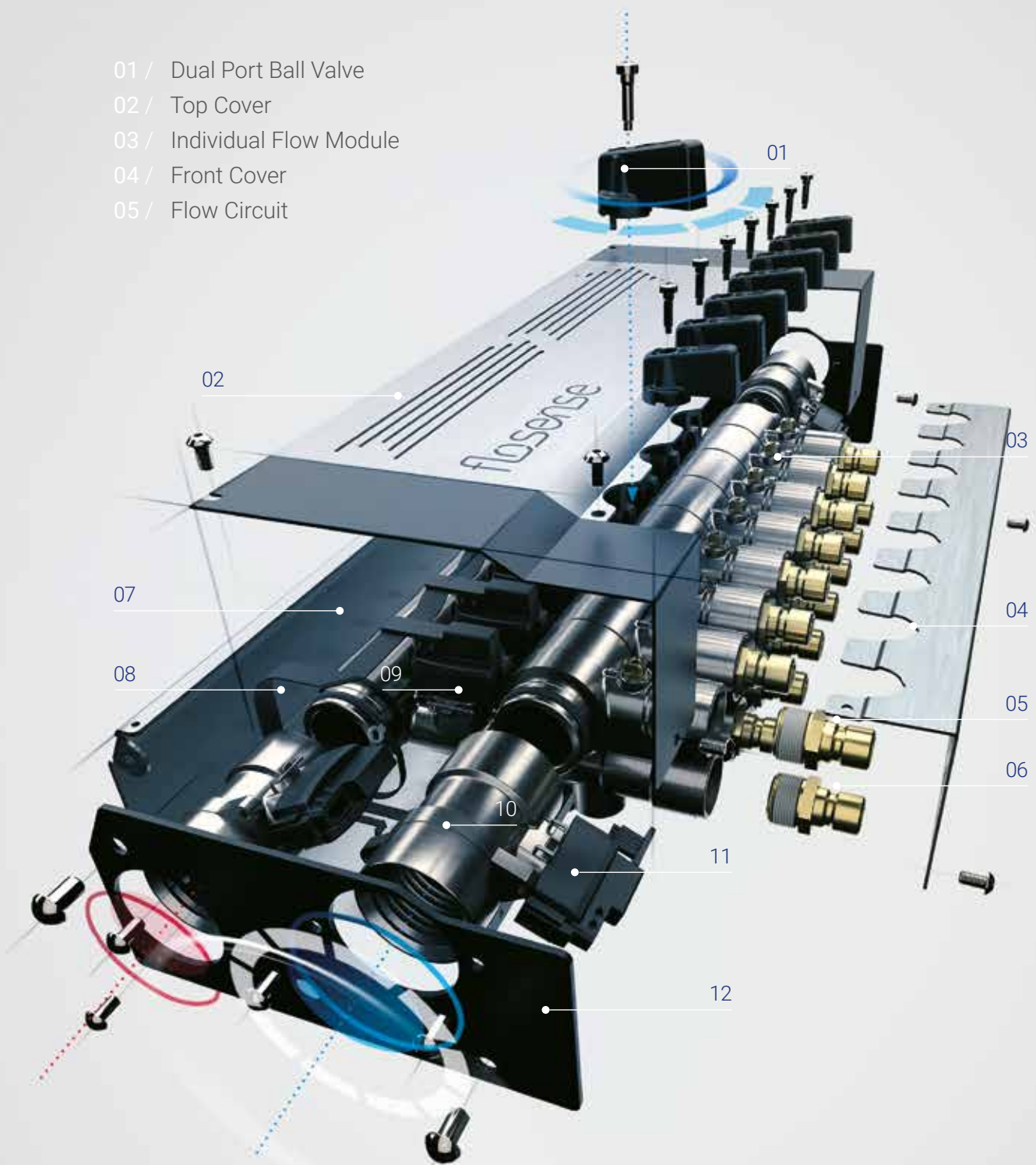

- 06 / Return Circuit
- 07 / Base Frame
- 08 / Cable
- 09 / Flow / Temperature Sensor
- 10 / End Module
- 11 / Pressure / Temperature Sensor
- 12 / End Plate



SYNC



VNC CONNECT

With the inbuilt **VNC Server** it is possible to mirror the Flosense software onto the moulding machine controller (or any other ancillary equipment with VNC Client capability). For maximum flexibility the Flosense display can be mounted at the rear of the moulding machine, close to the manifolds, for ease of setup.

VNC Connect is a very simple integration eliminating the need for specialist software development and allowing the user to always have the very latest in flow monitoring software. With the Flosense software operational from the machine controller this keeps the number of screens on the front of the machine to a minimum.

ACCESSORIES

Manifold / Extension cable

PART NO.	Connection	Length (mm)
FS-3P-EC1000	M8/M8/3P	1000
FS-3P-EC2000	M8/M8/3P	2000
FS-3P-EC5000	M8/M8/3P	5000
FS-3P-EC10000	M8/M8/3P	10000



Blanking Plug

PART NO.	Connection	Seal
SSEC1	1" BSPP	FKM



Port Connector Plugs

PART NO.	Connection	Size/Series
09NRF	R 1/2"	09 EURO Style
13NRF	R 1/2"	13 EURO Style
20NRF	R 1/2"	20 Int. Style
30NRF	R 1/2"	30 Int. Style
08NRF	R 1/2"	French Type Style
F9NRF	R 1/2"	French Matic Style
06NRF	R 1/2"	06 Scandinavian Style
10MF	R 1/2"	10 mm Hosetail
13MF	R 1/2"	13 mm Hosetail
25MF	R 1"	25 mm Hosetail
38MF	R 1"	38 mm Hosetail



Series 09



Series 13



Series 20



Series 30

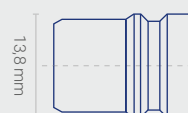

Series 8

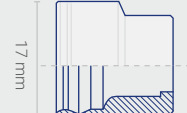

Series 9

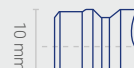

Series 6



SPECIFICATION

MATERIALS	
Modules	Nickel Plated DZR Brass (Corrosion resistant)
Main Feed	R1"
Circuits	R1/2"
Cover	Stainless Steel
DISPLAY	
Type	Touch
Size	7,1"
Voltage	12-24 Volt.
Data	USB + Ethernet
Communications	OPC UA
Internal memory	Up to 30 days data (FIFO)



FLOW	Standard Sensor	HT Sensor
Measuring range	0,5-10 l/min (0,16-3,7 gpm)	0,5-10 l/min (0,16-3,7 gpm)
	1-20 l/min (0,27-5,2 gpm)	1-20 l/min (0,27-5,2 gpm)
	2-40 l/min (0,53-10,4 gpm)	2-40 l/min (0,53-10,4 gpm)
Accuracy	($\pm 1 \sigma$) in water, $\pm 1\%$ FS	($\pm 1 \sigma$) in water, $\pm 1\%$ FS
TEMPERATURE		
Measuring range	0-120°C (32-248°F)	0-160°C (32-320°F)
Accuracy	15-90°C (59-194°F) ± 0.5 K	15-90°C (59-194°F) ± 0.5 K
	0-120°C(32-248°F) ± 1 K	0-120°C (32-248°F) ± 1 K
		120-160°C (248-320°F) ± 2 K
PRESSURE		
Measuring range	0-10 bar (0-145 psi)	
Accuracy	$\pm 2.5\%$ FS	

