

gabbiani g2/gt2

automatic horizontal beam saws

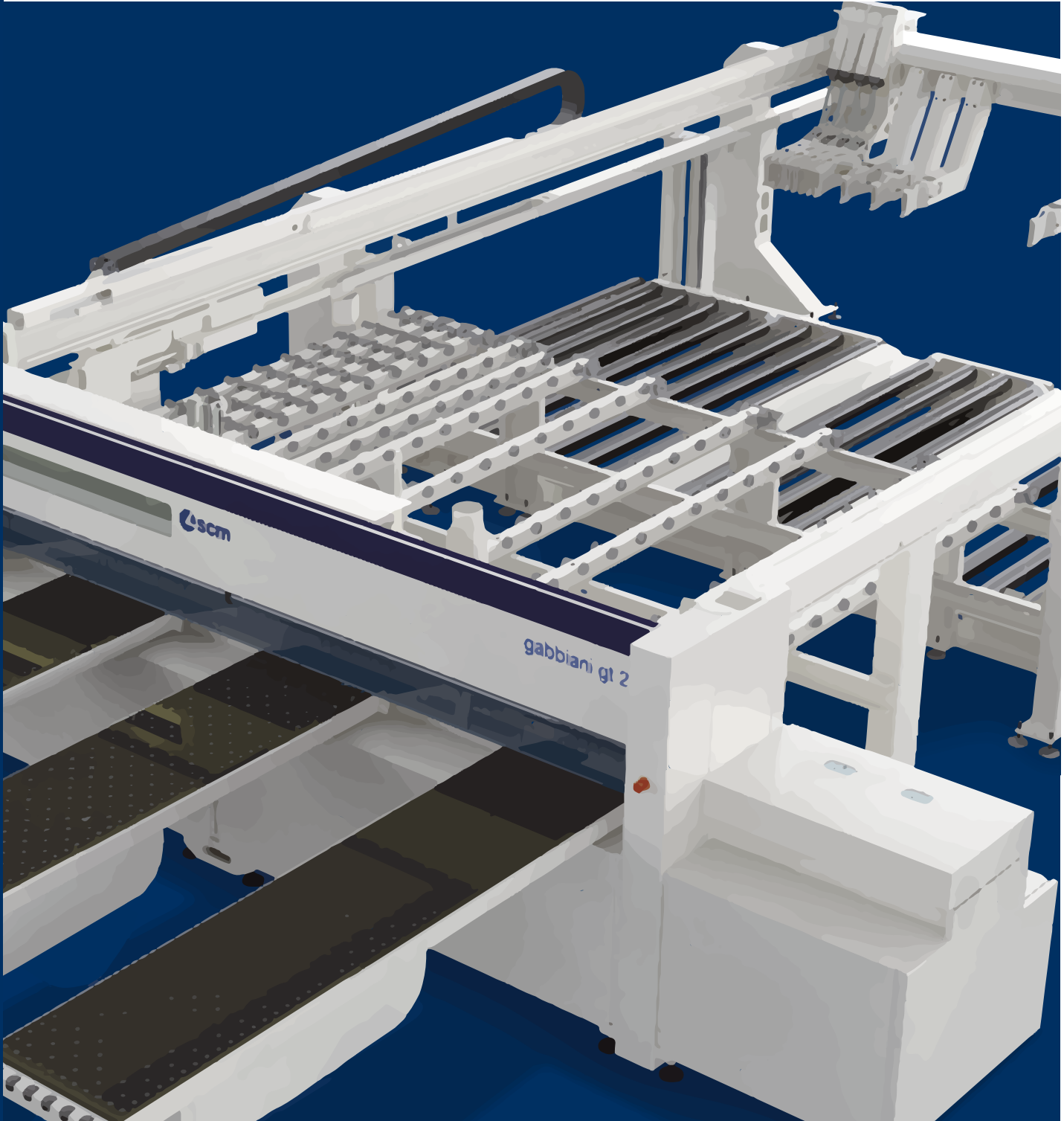



A NEW BOOST IN



PRODUCTIVITY, QUALITY AND PRECISION

SIMPLICITY



Ease of use for machining with dedicated units.

PERFECTION



Immediate cuts with the maximum cleanliness of the working table.

QUALITY



Maximum quality of the finished product thanks the presence of optional designed to preserve the most delicate surfaces

POWER



No cutting limit.
No loading limit.
No limit for integration with lines.

SOFTWARE



Planning and monitoring of the entire sizing process, both on board as well as in the office.

8	PERFECTION AND FLEXIBILITY OF CUT
14	OPTIONAL DEVICES
26	SOFTWARE MAESTRO
34	OVERALL DIMENSIONS

TECHNICAL FEATURES OVERVIEW

TECHNOLOGICAL ADVANTAGES



Maestro Active HMI

Maximum control of production performance, advanced production organization, total control of machine events, webcam



Floating clamps: safe grip at the maximum speed, also when panels are not perfectly planar.



Air floating table: an essential tool

High efficiency air floating table with feeding rollers eases the sliding of heavy or delicate materials. Maximum protection against risks of friction.



Powered side alignment device

Drastic cycle time reduction and better grip of the piece by means of the brushless motor.



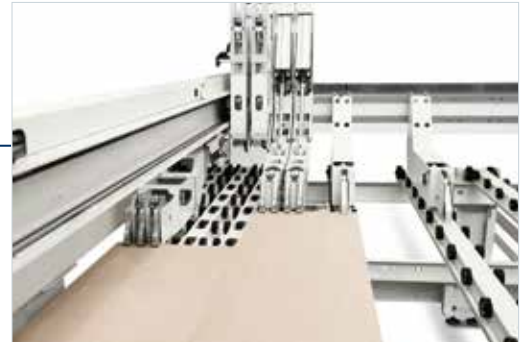
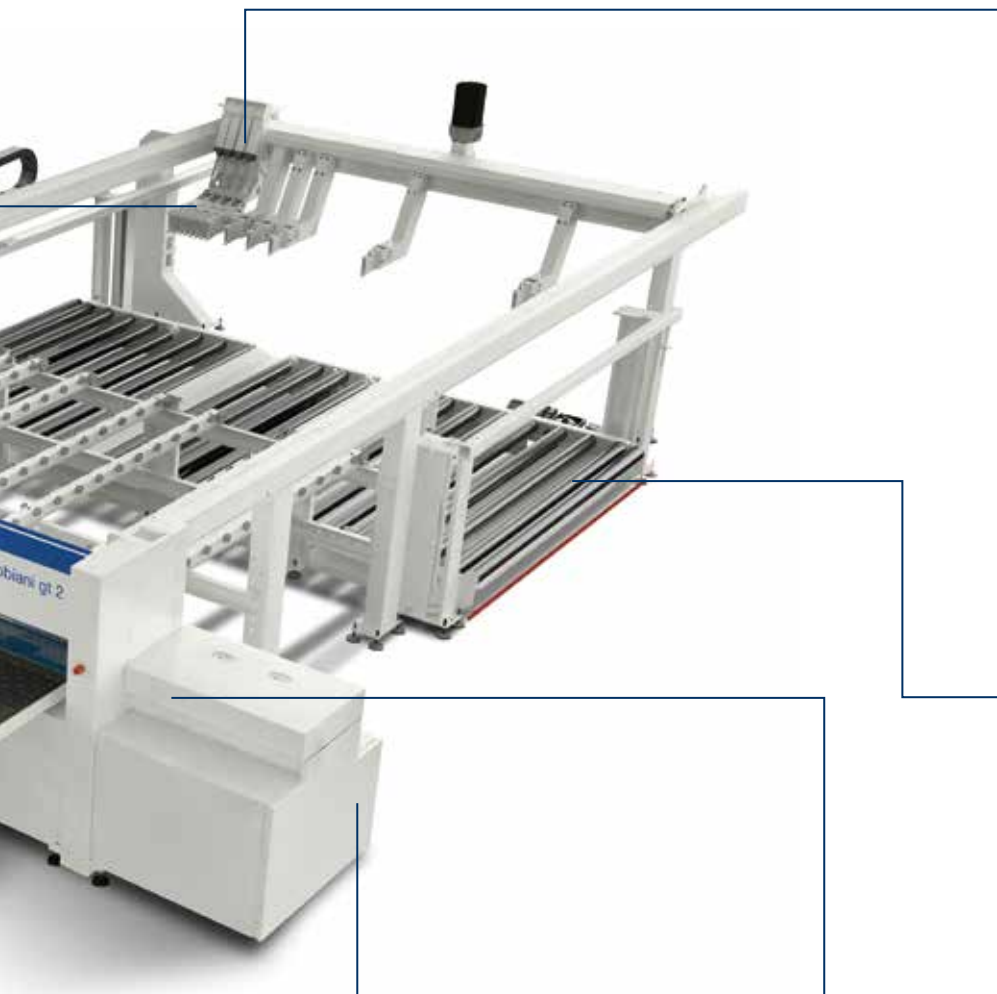

FLEXCUT

Modular FLEXCUT system. It enables the processing of complex cutting patterns in very rapid cycle times.



Loading platform

High customization and maximum versatility according to the user's requirements, with powered roller conveyor with trilateral loading (opt. on gabbiani gt2).



Hi-Tronic vertical stroke device:
top of productivity with the new saw carriage (opt).



SAW-SET: *tool changing has never been so easy. Fast and precise tools adjustment due to the electronic setting (opt.)*

PERFECTION AND FLEXIBILITY OF CUT

THE BASE: THE VERY BEST RESULT IS GUARANTEED

Solid and compact machine base ensures precise carriage movements by providing maximum cutting quality for many years.



AIR FLOATING TABLE: AN ESSENTIAL TOOL

High efficiency air floating table with feeding rollers eases the sliding of heavy or delicate materials.

Maximum protection against risks of friction.

PUSHER WITH BRUSHLESS MOTOR: ALWAYS HIGH PERFORMANCES

The best quality and the maximum working speed thanks to the pusher stroke on rectified round guides. The machine base is composed by sturdy tubular steel with wheels for moving panels, even the heaviest without damaging them.





QUALITY SLIDING ON THE CARRIAGE WITH RECTIFIED ROUND GUIDES:

Speed, maximum linearity and precision that last with our structure.



INVERTER: NO COMPROMISE

The possibility to adjust the main blade speed allows a perfect finish with any panel stack height.



OPTIMISED BLADE HEIGHT: FOR SMART CUT

The main blade projection is automatically adjusted according to the panel thickness to be cut. It always guarantees an optimum cut quality and reduces the machine cycle time (optional).

PERFECTION AND FLEXIBILITY OF CUT



PRESSURE BEAM: MANY QUALITIES IN A SINGLE STRUCTURE

This new structure guarantees a uniform pressure on panels and an optimum extraction of shavings and sawdust with the triple dust conveying system (one on the top applied directly to the pressure beam, one on the bottom applied to the saw carriage and another one on the lateral beam). Absence of maintenance is granted thanks to the mechanical solution studied by SCM which foresees the pressure beam movement on prismatic guides.



REAR PNEUMATIC SIDE ALIGNER FOR CROSS CUTS:

perfect alignment of the piece against the squaring fence and cycle time reduction.



FLOATING CLAMPS WITH SINGLE FINGER:

The special shape of the clamps allows safe grip of panels at the maximum speed and perfect parallelism, even when panels are not perfectly planar.

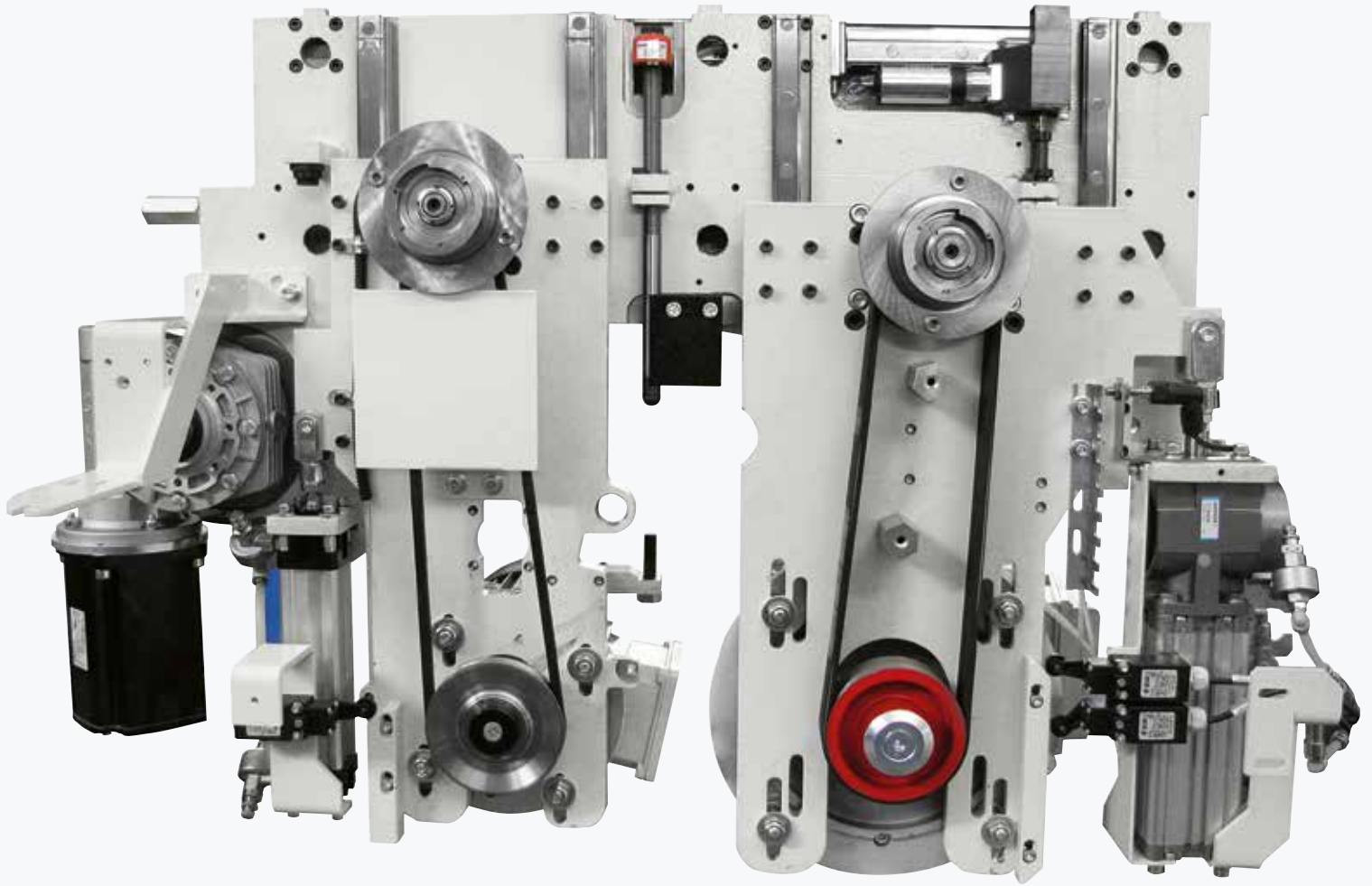

Sturdy saw carriage with independent pneumatic raising of the main blade and scoring blade, on prismatic guides with recirculating ball screws.



OPTIONAL CUT SOLUTIONS FOR EVERY NEED

SCORING UNIT ELECTRONIC ADJUSTMENT: TECHNOLOGY FOR A REAL SUPPORT

The setting from the PC allows the management of a powered system for the scoring unit automatic positioning, drastically reducing the blade set-up time and avoiding any possible errors.

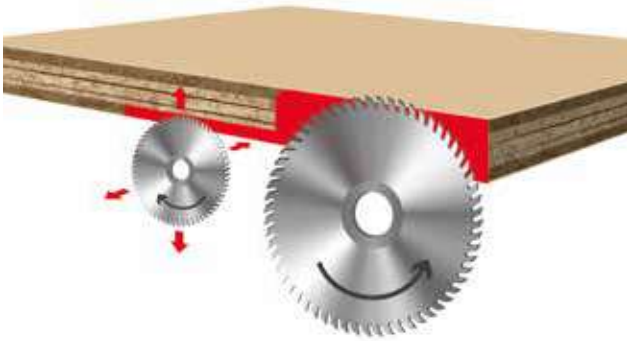

POSTFORMING

Lateral scoring of edged and postformed bars by means of the scoring blade rise.



SLOTS EXECUTION DEVICE: AT THE OPERATOR'S SERVICE

This particular device allows the carrying out of interrupted cuts inside the panel to produce, for example, slotted doors.



EXECUTION OF PANELS DE-TENSIONING CUTS

Device that reduces tensions inside the material on longitudinal cuts guaranteeing cut linearity.

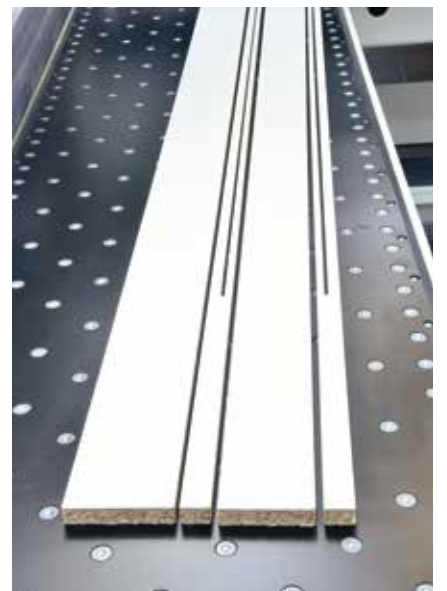

**GROOVING EXECUTION:
PRODUCTION AND FLEXIBILITY**

Grooving execution allows machine customization and makes the machine more productive and versatile.

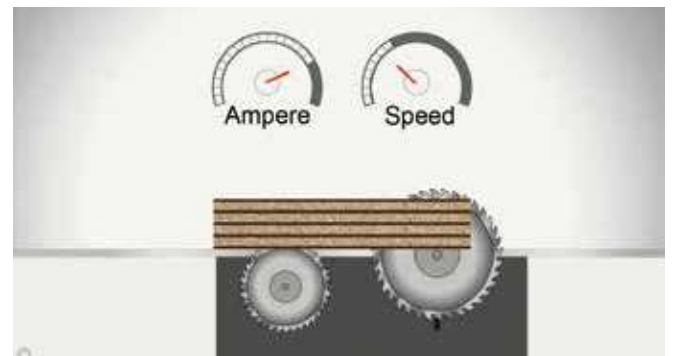
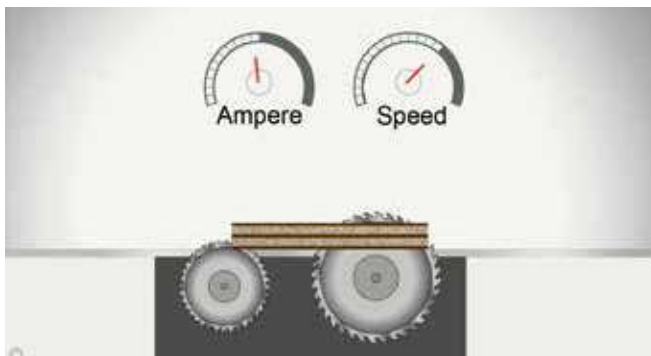
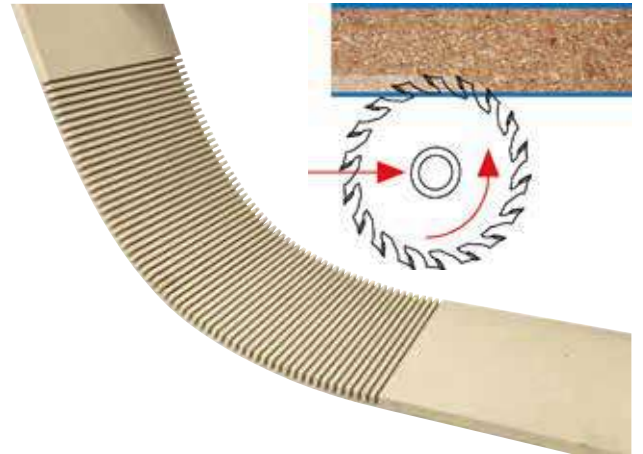

ADAPTIVE CONTROL OF THE SAW CARRIAGE SPEED: TO WORK SAFELY

The automatic monitoring of energy absorption of the motor according to the thickness/type of material and the type of the blade used gives the best results avoiding errors or wastes.



Clamps with on/off pneumatic stops for covered panels with overhanging edges.

OPTIONAL DEVICES



PRISMATIC GUIDES WITH RECIRCULATING BALL SCREWS: IMPROVE MACHINE PERFORMANCE

Minimum friction and automatic lubrication with a remarkable maintenance reduction.

Maximum speed reachable both during the feeding stroke (100 m/min with a single sheet, 50 m/min with a panel stack) and the return stroke (up to 170 m/min).

THE PRESSURE BEAM FOR ANY MATERIAL, EVEN THE SOFTEST ONE

The pressure beam with axis controlled by pc is positioned at the cutting height entered by the operator, ensuring a perfect grip of the piece during cutting operations. The surfaces of materials to be processed (honeycomb, cardboard, and other materials) will stay safe.





ZERO-DUST SYSTEM

Device for table cleaning that prevents the accumulation of sawdust. A modular control curtain is activated at every cut by section, in order to limit the dust emission and guarantee a complete evacuation. This allows for optimal cleanliness inside and outside of the machine with no risk of damaging the moving components of the saw carriage. Placed both on the cross and longitudinal cutting axes (optional).



OPTIONAL DEVICES

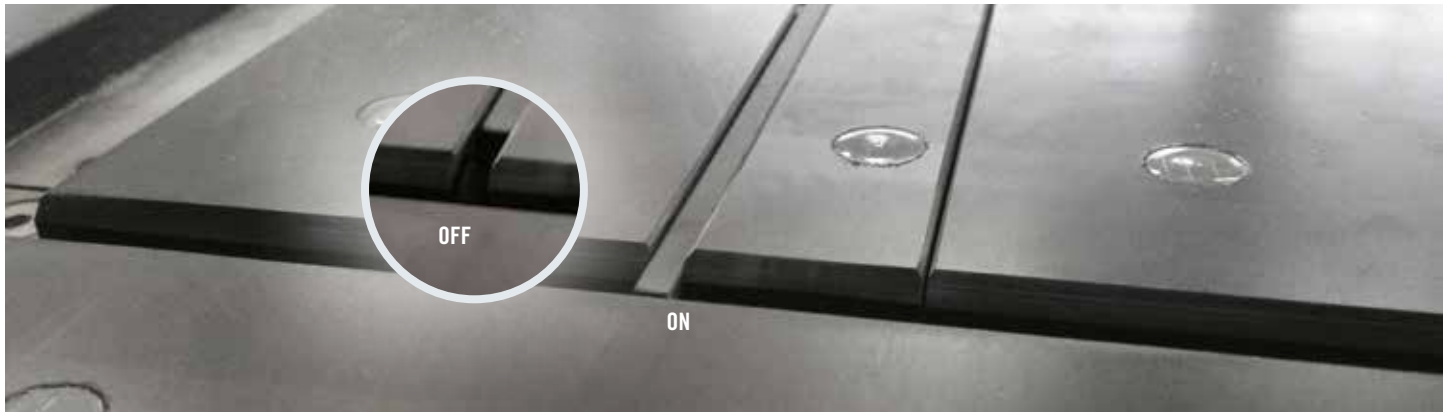

AUTOMATIC CLOSURE OF THE CUTTING LINE: it avoids the fall of waste trim cuts inside the machine.



POWERED SIDE ALIGNMENT DEVICE: drastic cycle time reduction and better grip of the piece by means of the brushless motor.

DEVICE FOR THE SELECTIVE CLOSING OF THE CLAMPS:

the special shape of the clamps allows a safe panel grip at the maximum speed, while the selective closing device prevents ruining panels which edges are exactly positioned in correspondence of the clamps working area.





OPTIONAL CUT SOLUTIONS



RAPID BLADES LOCKING/UNLOCKING: MACHINING SAFETY IN A REDUCED TIME

This system provides safe and constant blades locking and unlocking, due to the pneumatic system which minimizes the stand-by times for blade changeovers.

SAW-SET: TOOL CHANGING HAS NEVER BEEN SO EASY

In a few seconds the "SAW-SET" device carries out fast and precise tools adjustment due to the electronic setting, allowing an intuitive use of the machine and a productivity increase.



video saw set

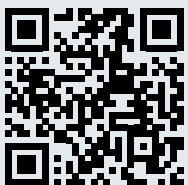

AKE DEVICE

Rapid locking/unlocking of the scoring blades with “AKE” mechanical flanges “EASYFIX” (“AKE” patent) allowing a quick and easy change of the blades. The tightening is ensured both with high blade-motor power and machining of the hardest materials.



“HI-TRONIC VERTICAL STROKE” DEVICE: TOP OF PRODUCTIVITY WITH THE NEW SAW CARRIAGE

The device allows an optimum finishing and precision cut even at high speed. The device includes:

- optimized blade stroke
- fast blades unlocking with AKE mechanical flanges
- self-learning pressure beam
- post-forming
- scoring blade electronic adjustment
- electronic mortising device
- cuts out “windows”



FLEXIBILITY AND PRODUCTIVITY

FLEXCUT

The modular FLEXCUT system enables the processing of complex cutting patterns in very rapid cycle times.

Incomparable precision.

The use of brushless motors sliding on prismatic guide with recirculating balls screw reduces mechanical parts friction and guarantees best precision.

The extreme flexibility of these devices is also ensured by the presence of the main pusher grippers, which can be excluded from the working area, so that strips with different widths can be secured and as a result any type of different cutting can be performed without limiting the stroke.

**INCREASING OF PRODUCTIVITY UP TO 40% AND SPACE SAVING UP TO 20%
THANKS TO THE SIMULTANEOUS EXECUTION OF BOTH RIP AND CROSS CUTS.**

SIMULTANEOUS EXECUTION OF TWO-DIFFERENTIATED CUTS

Devices consisting of a mobile grippers unit whose stroke is completely independent due to the two independent pushers which enable the following operations:

- cross and rip cuts
- cross cuts on side-by-side bars
- cross cut during the platform loading of a following longitudinal cut

FLEXCUT 1/S

Effective panels movement with the use of the triple “finger” clamp.



FLEXCUT 1/D

Extreme flexibility of the device because the mobile unit is fitted with two grippers with double finger, one of which can be excluded, in this way guaranteeing a wide variability in the width of the strips that can be gripped.

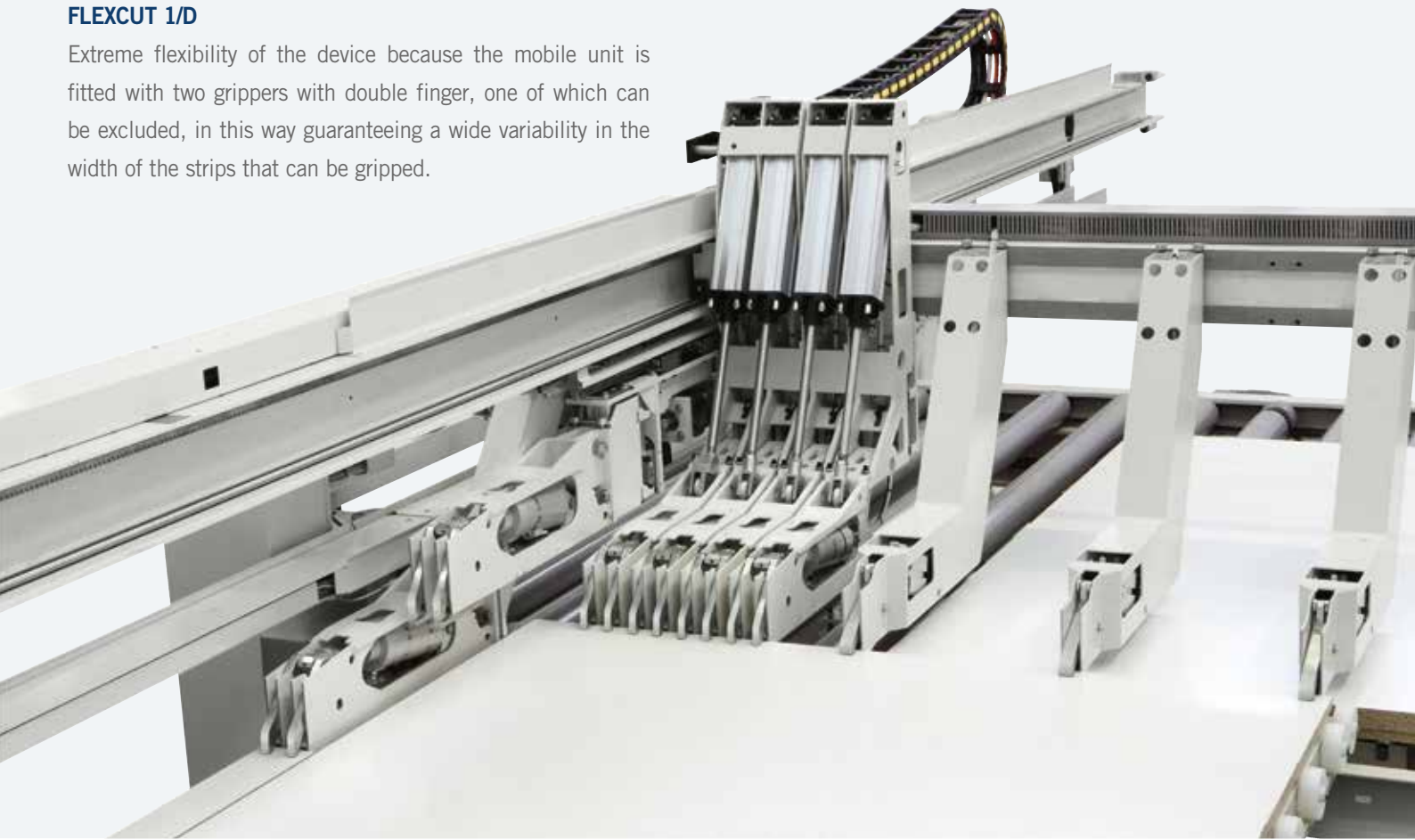

AUTOMATIC LABEL PRINTER ON ADDITIONAL PUSHER

Automatic labeling in masked time allows all relevant data to be transmitted to the workpiece before the cutting process. The application of the label takes place optimally upstream of the cutting process because it has a dust-free surface.



LOADING PLATFORM

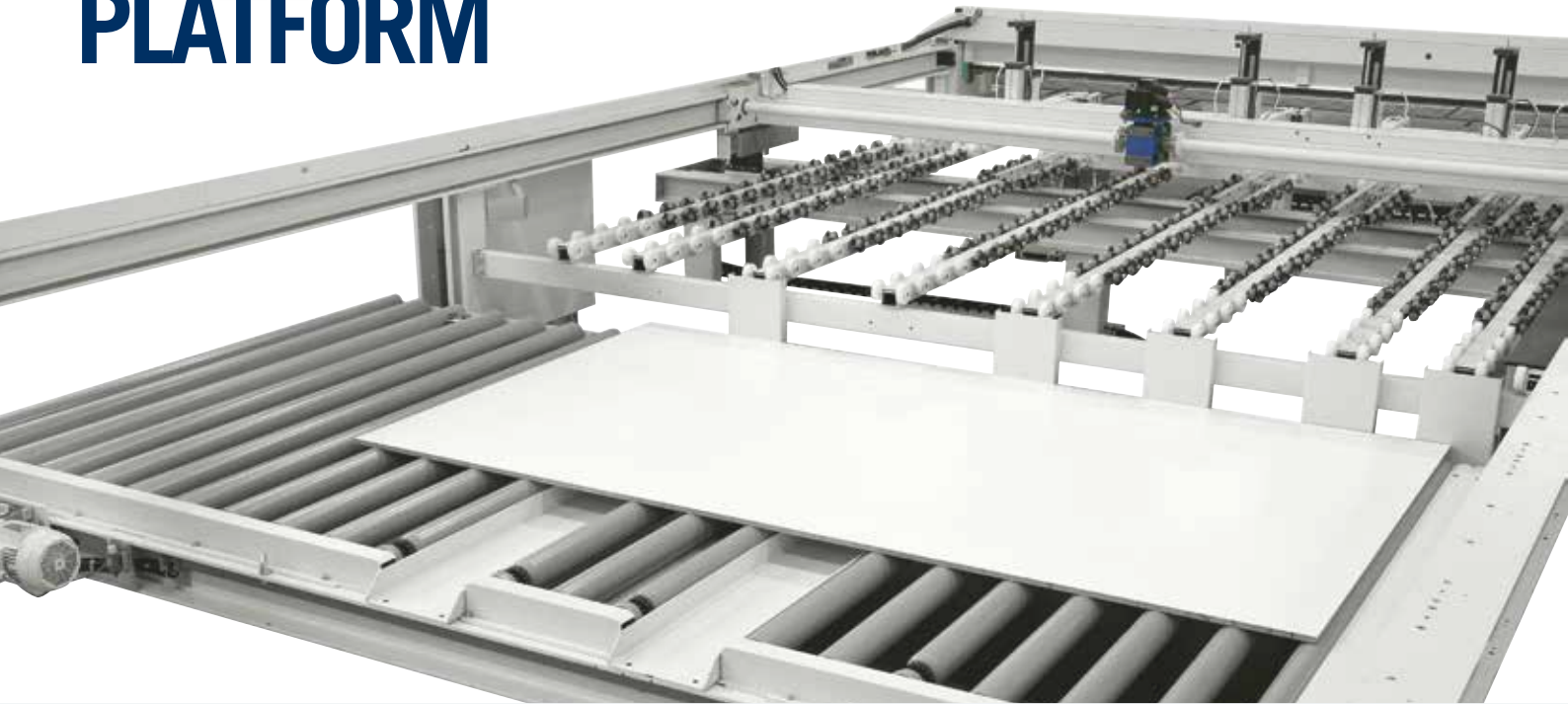

LOADING PLATFORM: WHEN STURDINESS AND PRECISION MAKE THE DIFFERENCE

The lifting system running on 4 large trapezoidal screws is able to maximize the load capacity, with any material and format, always ensuring a parallel lifting of the panels stacks.

In this way machine downtimes are avoided achieving maximum productivity.

PRELOADING ROLLER CONVEYORS: SPACE IS NOT A PROBLEM ANYMORE

One or more preloading roller conveyors allow the endless running of the saw. Loading and unloading systems of the “half stack” and the baseboard or pallet handling offer effective solutions to space and production needs.

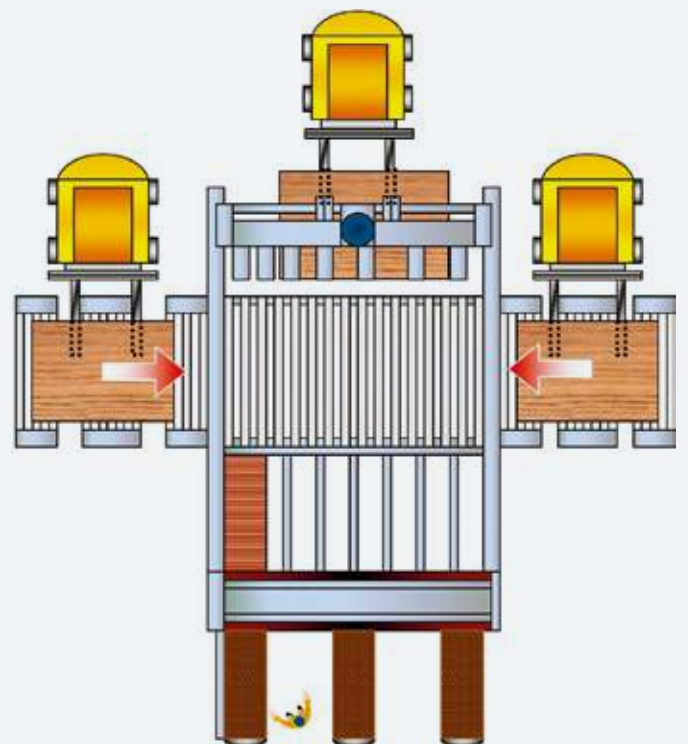
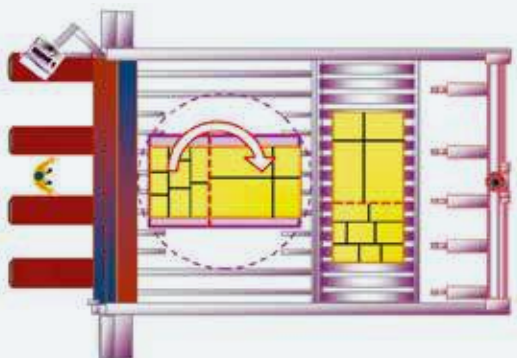



AUTOMATIC HEAD-CUT MANAGEMENT DEVICE: PRODUCE FASTER

A sturdy metallic frame holds up the panels stack during the rotation cycle.

The main pusher automatically moves the panels stack from the loading rear table to the center of the rotating table.

The system automatically manages the cutting of the “Slave” section and the reintroduction and rotation of the “Master” section.

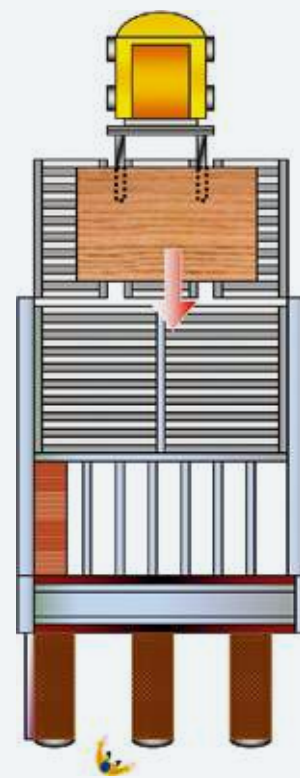
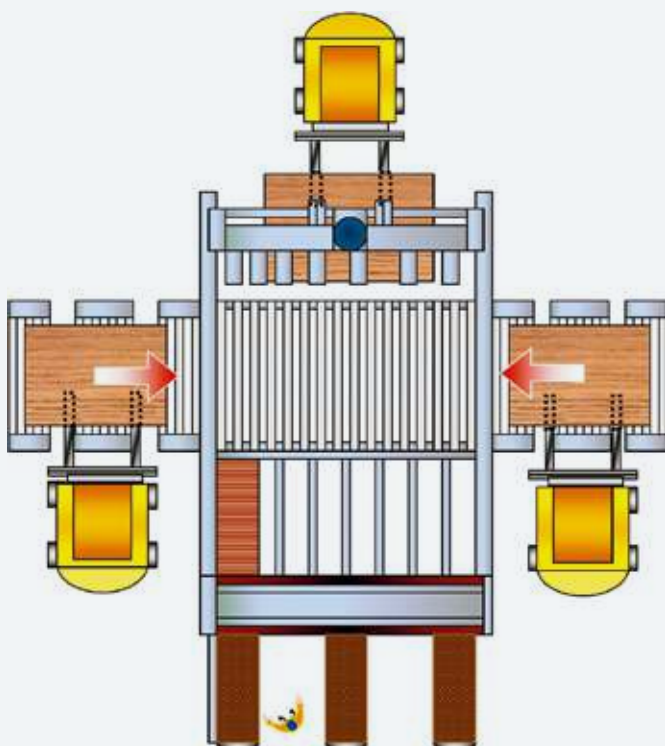

AUTOMATIC LOADING OF THIN AND DELICATE PANELS



AUTOMATIC LOADING SYSTEM OF THIN PANELS: GABBIANI EXPERIENCE AT CUSTOMER DISPOSAL

Precise and effective device which ensures the automatic loading of thin panels with thickness ranging between 3 and 10 mm.



THE DEVICE FORESEES THE MACHINE WORKTABLE WITH CLOSURE COVERS

For the thin panels stack loading/unloading it is compulsory a support panel (25 mm minimum thickness). The minimum panel stack which can be loaded and aligned is 15 mm.





**SUCTION CUP LOADING SYSTEM:
THE PERFECT SOLUTION FOR PANELS WITH DELICATE COATING**

The suction cup loading system is integrated in the machine to guarantee minimum space requirements.

The suction device takes the single panel and puts it down in masked time in the alignment station inside the machine.

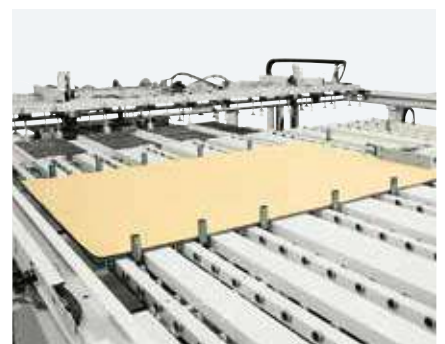
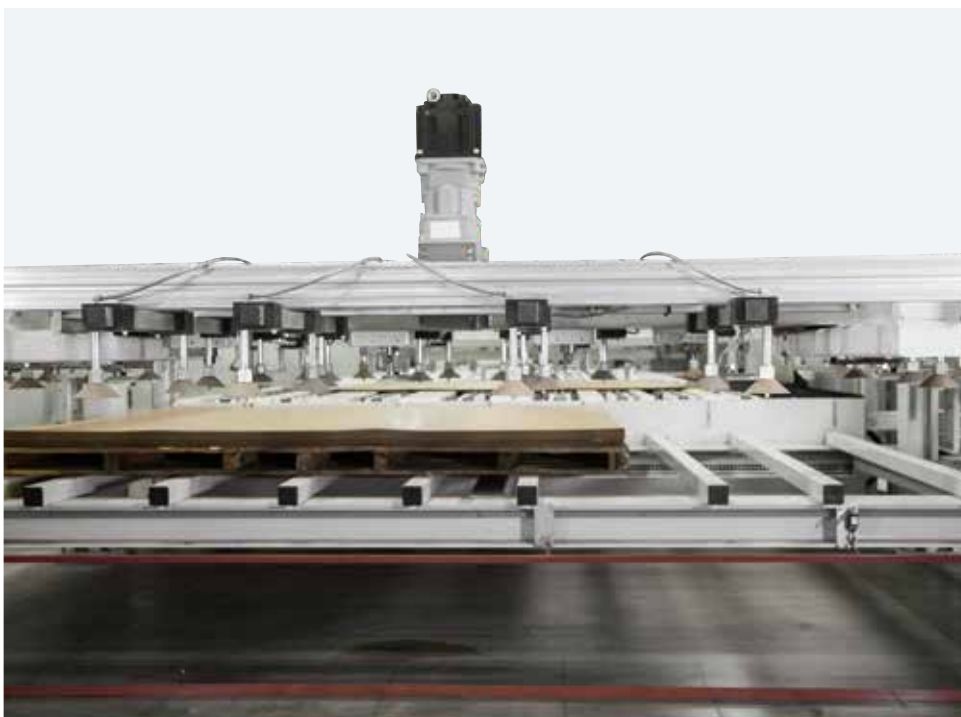

M Maestro Digital Systems

SMART SOFTWARE AND DIGITAL SERVICES TO ENHANCE PRODUCTIVITY OF WOODWORKING AND FURNITURE INDUSTRIES.

cutting lists



optimized cutting patterns

Maestro office

Office



Factory

Maestro active

optimized cutting patterns



cutting

SOFTWARE

Simple, smart and open.

Maestro software are tailored on the machine technology as well as on the entire process. All Maestro software share a common mission:

easy to use, so that any operator can easily and confidently learn and use the software

smart, with algorithms and computing modules aiming at the best possible result

open in order to integrate existing software, and provide customer the coverage of all his process

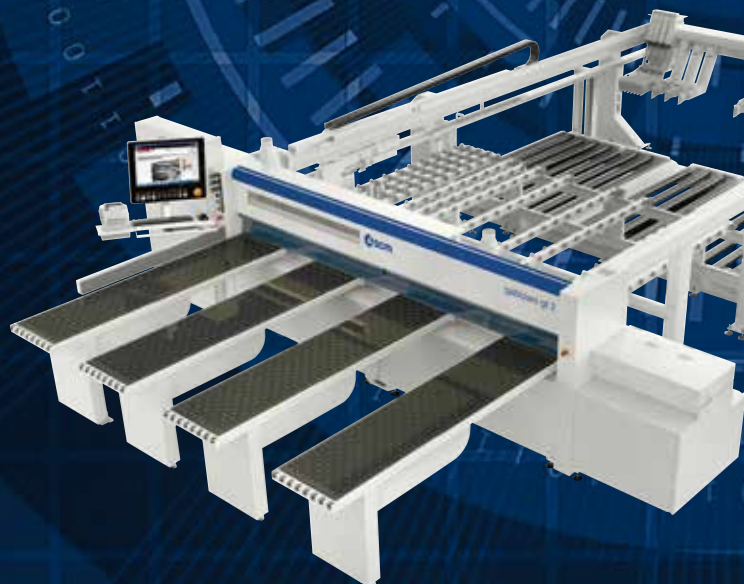

SCM accompanies woodworking companies throughout their whole process combining machines with matching software solutions and digital services, with a constant strive to enhance company productivity.

The software solutions powered by SCM are developed to optimize machine usage as well as the entire process, providing integration with the different software existing in the company.

DIGITAL SERVICES

Transforming the way it delivers services to its customers through digital technologies and particularly, the IoT platform that collects and analyses data coming from the machine, **SCM created a world of services enabled by Maestro connect.**

Meaning that connecting an SCM machine through Maestro connect will let customer subscribe a program of fast-evolving services and access a wide range of benefits that even go beyond the machine experience and will support and assist you through the whole life-cycle of your machine.

Maestro connect IoT Platform

1
Machine monitoring,
KPIs, early warning

2
Maintenance
equipment

3
Predictive
maintenance

4
Report and historical
data export to MES

5
Warranty
extension

6
Augmented remote
support

7
Smart learning,
SELF-HEALING,
video tutorials

8
Asset management
with e-shop SCM
Spare Parts





SCM LINEAR CUTTING OPTIMIZATION PROGRAM

In the office **Maestro optiwise** and **Maestro pattern office** provide support during the design and optimization phases. **Maestro pattern office** is the standard optimization program that can be used from the office for simple and efficient creation of cutting programs. **Maestro optiwise** is the linear cutting optimization program created for production management directly from the office. Depending on users' parameters, it automatically generates the cutting patterns, identifying the best solution among different results.



SOFTWARE

Office

TO EACH HIS OWN OPTIMIZATION SOFTWARE

Maestro pattern office is the standard optimization program for all SCM machines. **Maestro optiwise** is the professional software for controlling the entire costing and optimization process of the beam saw.

ADDITIONAL FUNCTIONS



Maestro pattern office

Maestro pattern office is the office version of the standard optimization program for all SCM machines. Maestro pattern office is the result of the integration between Maestro pattern - the standard optimization program on all SCM beam saws controls – and Maestro pattern import.



Maestro optiwise

Maestro optiwise is the professional software supplied by SCM for beam saws management. The main strengths are:

- Improved user experience: The user can easily and effectively carry out all raw material optimization operations.
- Increased efficiency: Improved user-experience enables required tasks to be performed in less time, increasing productivity
- Less effort for customization: the application is designed with a modular architecture that allows it to be easily adapted to each customer's production logic.
- Faster user learning: The application is a useful and simple tool that allows users to be productive in the shortest possible time.
- Multi-machine management: The application is able to manage optimizations and create machine programs for single-blade panel saws and angular systems.



Maestro converter cut

Maestro converter cut is the module that allows to integrate any type of cutting optimization programs with SCM beam saws through PTX file (minimum release 1.14).

Maestro active cut

Maestro active is the new operator interface software which has been unified across all SCM technologies. A single operator can easily and confidently run multiple machines due to controller and interface consistency: regardless the machine, Maestro active maintains the same look&feel, with many identical icons and navigation buttons, thus ensuring the same approach to interaction.

EASE OF USE

The new interface has been specifically designed and optimized for immediate use via touch screen. Graphics have been redesigned for simple and comfortable navigation, with tablet-like icons on touch screen controller.

"ZERO" ERRORS

Improved productivity thanks to integrated help and recovery procedures that reduce the possibility of error from the operator's side.

SOFTWARE

Factory

Maestro active cut

A REVOLUTIONARY APPROACH TO INTERACT WITH YOUR SCM MACHINE

FULL CONTROL OF PRODUCTION PERFORMANCES

The creation of customizable reports by operator, shift, program, forecast period (and much more) allows to monitor, optimize and improve the production performance.

FULL MACHINE AWARENESS AND KNOWLEDGE MANAGEMENT SYSTEM

Maestro active allows to record the times related to setup, maintenance, training and other events, tracing all the activities in a database. The operator's know-how is also stored and made available to other people inside the organization thanks to the possibility to comment and document all production events or notifications.

ORGANIZE YOUR PRODUCTION

Maestro active allows to create different users with different roles and authorizations (e.g.: operator, maintainer, administrator, ...). Any user can only execute the functions whose permissions have been assigned to him. It is also possible to define the work shifts on the machine and then detect activities, productivity and events that occurred in each shift.

OPTIMIZATION FUNCTION ON BOARD MACHINE

Maestro pattern is the linear cutting optimization program for user who wants to optimize cutting patterns with a few simple clicks.

SUPPLEMENTARY MODULES



Maestro pattern import

Maestro pattern import is the optional plug-in module which enables Maestro pattern importing production data directly from an MS Excel file.



Cut utility

Cuts editor for panels de-tensioning: software program that reduces tensions inside the material on longitudinal cuts; additional optimisation functions; off-cuts stock management: identification and automatic insertion of the off-cuts for a future use.



Cut editor

Labels printing software, panels editor, editor for Macro machining creation.



Cut manager

Simulator for cycle time calculation, simulated execution of the cutting diagrams of single or multi orders in 2D mode; priority-based and date-based scheduling of the order; advanced report.

A WORLD OF SERVICES FOR GREATER EFFICIENCY

Maestro connect

CONNECT YOUR MACHINE AND GAIN ACCESS TO A WORLD OF SERVICES

Connecting your machine through Maestro Connect will let you subscribe a program of fast-evolving services. You will access a wide range of benefits that even go beyond the machine experience and will support and assist you through the whole life-cycle of your machine.

FASTER SERVICE INTERVENTION AND PROBLEM RESOLUTION

Maestro Connect provides real time data and Health Records of the Machine also to SCM Service drastically reducing its troubleshooting time.

WORKING ALWAYS IN PERFECT CONDITIONS

Maestro Connect can provide a full kit of sophisticated sensor devices to detect and warn the operator in case of alarming conditions of the machine.

DIGITAL SERVICES

SMART MAINTENANCE: DOWN TIME REDUCTION

Maestro Connect reduces maintenance downtime thanks to:

- Automatic maintenance notifications and scheduling, to prevent failures and work in the best conditions of use
- Direct connection to SCM Service thanks to an automatic ticket opening function

SMART MACHINE: ANYTIME, ANYWHERE AWARENESS

Connecting your SCM machine also means having your machine always at hand.

Immediate instant notifications in case of alarms or downtimes allow customers to immediately take an action thus optimizing his productivity.

SMART MANAGEMENT: PRODUCTION PERFORMANCE OPTIMIZATION

Reports and KPIs allow further analysis thus increasing Customer Knowledge about his performance and results.

SMART PARTS: FAST PARTS REPLENISHMENT

Repairs are scheduled proactively since the system provides Spare Parts suggestions and a direct Integration with Smart Parts e-shop.

SMART LEARNING: EXECUTE WORK AND RECEIVE PROBLEM SOLVING SUPPORT

Maestro connect provides an intuitive Problem Solving Management System to help the operator to self solve any issue.

SMARTECH: FASTER AUGMENTED SUPPORT

Maestro connect allows augmented reality support by means of Smartech: the head-wearable computers with wireless connectivity that will bring the interaction between customer and SCM service to a higher level.

SMART WARRANTY: YOUR MACHINE ALWAYS IN PERFECT CONDITIONS

Together with scheduled maintenance contracts, you can take care of your asset by doubling the warranty from 1 year to 2 years* for complete peace of mind!

* Please read the complete contract to understand terms and conditions.

CONSOLE EYE-M

gabbiani g2/gt2
automatic horizontal beam saws



*"console
eye-M "*
Video



INTEGRATED SOLUTIONS

FLEXSTORE ELR STORAGE FULLY INTEGRATED IN THE BEAM SAW: OPTIMISING HAS NEVER BEEN SO EASY

flexstore elr is the SCM solution for the **needs of companies making items to order** with “just-in-time” production: processing orders quickly, keeping costs down and high quality and productivity standards.

flexstore elr is the automatic storage system which is able to serve beam saws, guaranteeing precision, **high component quality** and great **reliability**.



The excellent materials management permits high productivity and flexible machining.

It ensures:

- material savings thanks to management of material remaining after machining
- maximum flexibility for multi-function cells
- optimized material management in the production process: less space occupied, without compromising on efficiency
- reduced risk of damage to material thanks to the absence of sliding movements
- full traceability for batch 1 production with automatic labelling
- machines with integrated production process
- reduced order execution times



SECURE AND PRECISE PANEL TRANSFER.

The suction cup arm automatically adapts to the different lengths and widths of the panels to be picked up.

INTEGRATED PANEL SAWS WITH ANTHROPOMORPHIC ROBOT

The main advantages of automatic operation with robot are reduced labor cost; Increased productivity, quality, and production without shift limits. The switch to manual mode allows handling of all materials that cannot be handled by the robot due to size and/or other characteristics (thin materials), and the possibility of parcel cutting.

Video gt2 with robot



OVERALL DIMENSIONS

gabbiani g 2

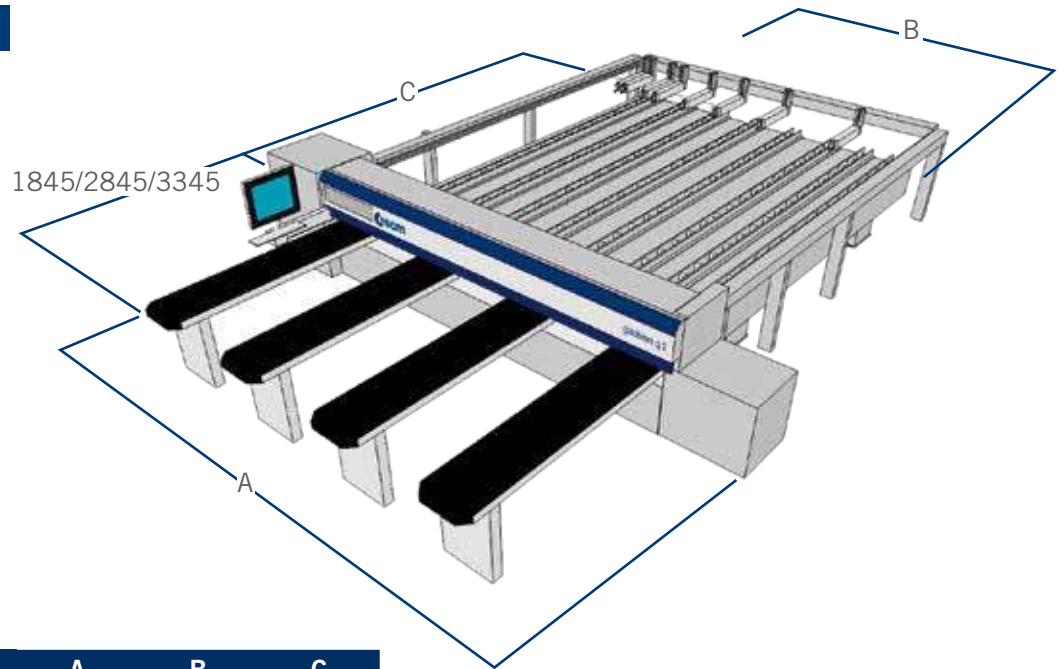

Cutting dimensions	A	B	C
3200 x 3200	5663	3761	4567
3800 x 3800	6263	4361	5279
4500 x 4300	6963	5061	5780

gabbiani gt 2

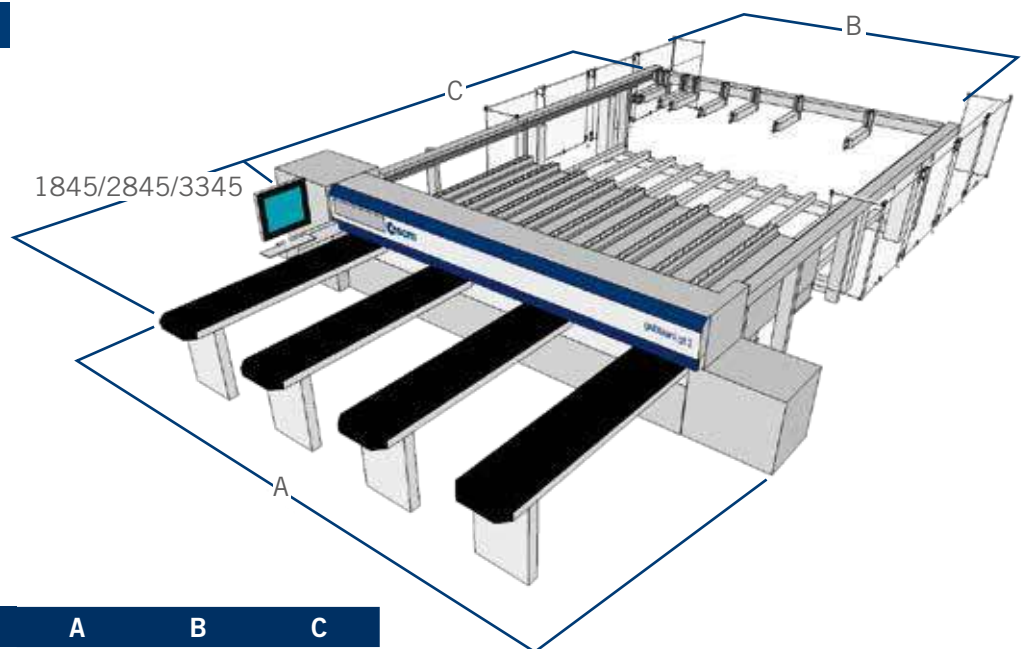

Cutting dimensions	A	B	C
3200 x 1850	5663	4513	6740
opt. 3200 x 2440	5663	4513	8100
3800 x 1850	6263	5113	6740
opt. 3800 x 2440	6263	5113	8100
4500 x 2440	6963	5813	8100

gabbiani gt 2 with rotating table

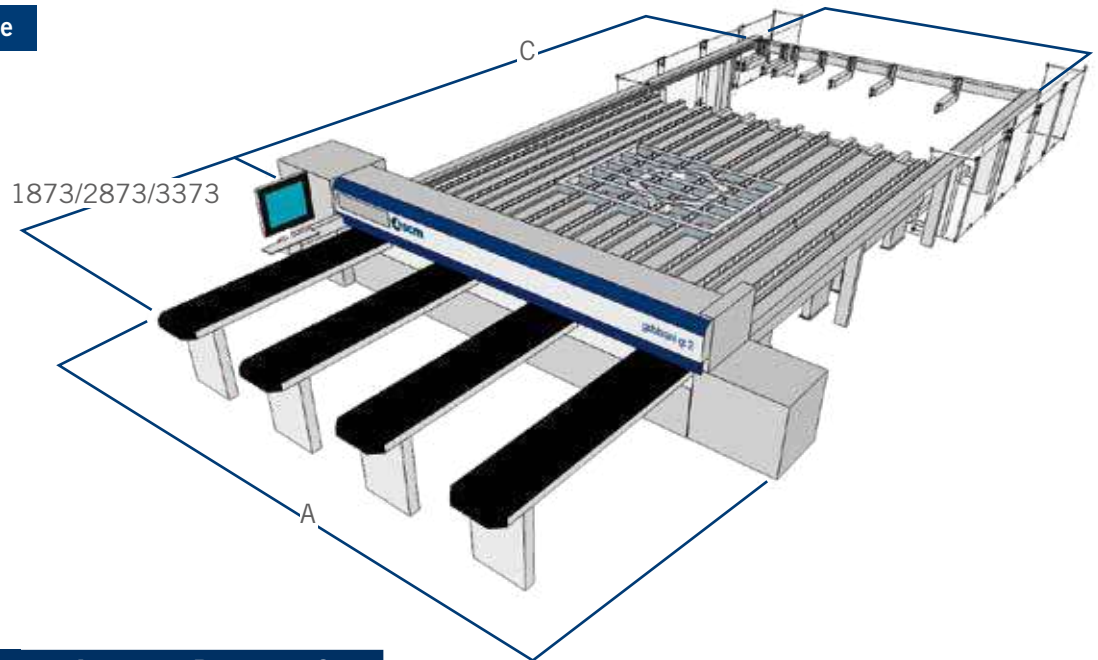

Cutting dimensions	A	B	C
3200 x 2440	5663	4513	10747
3800 x 2440	6400	5113	10747
4500 x 2440	7100	5813	10747



**SAVENERGY
LOWER CONSUMPTION = LOWER COSTS**

SavEnergy allows the use of **power only when it is required**, making things operate only when they are really necessary. It means the machine automatically enters “stand-by” mode when there are no panels to be machined at any particular time. Year saving up to 10% (optional).

**COMPANY WITH
QUALITY SYSTEM
CERTIFIED BY DNV
= ISO 9001 =**

The technical data can vary according to the requested machine composition. In this catalogue, machines are shown with options. The company reserves the right to modify technical specifications without prior notice; the modifications do not influence the safety foreseen by the CE Norms.

Maximum noise levels measured according to the operating conditions established by EN 1870-13:2012
Acoustic pressure in process 85 dbA (measured according to EN ISO 11202:2010, uncertainty K = 4 dB)
Acoustic power in process 103 dbA (measured according to EN ISO 3746:2010, uncertainty K = 4 dB)
Even if there is a correlation between above mentioned “conventional” noise emission values and average levels of personal exposure of operators over eight hours, these last also depend on the real operating conditions, duration of exposure, acoustic conditions of the working environment and presence of further noise sources, this means the number of machines and other adjacent processes.



SERVICE AND MAINTENANCE



TRAINING SERVICE



SPARE PARTS



DIGITAL SERVICES

SCM OFFERS A FULL RANGE OF **HIGHLY SPECIALISED SERVICES** WITH A QUALITY AND RELIABILITY THAT STEM FROM 70 YEARS OF EXPERIENCE IN THE INDUSTRY.

From installation and production start-up to services and maintenance. From training to the supply of specific original spare parts: **we provide solutions designed around you!**

CONTACT

SCM SERVICE

via Emilia 77 - 47921 Rimini - Italy
tel. +39 0541 700100
scmservice@scmgroup.com
www.scmwood.com

SCM SPAREPARTS

Via Emilia, 61 - 47921 - Rimini - Italy
tel. +39 0541 674111
spareparts@scmgroup.com
www.scmwood.com



My Scm

WE'LL GO THE EXTRA MILE FOR YOU



SERVICE AND MAINTENANCE

- Remote support
- Scheduled maintenance contracts
- Warranty extension



TRAINING SERVICE

- Courses for machine operators
- Software and programming courses
- Training in production start-up



SPARE PARTS

- Recommended spare parts list
- E-shop
- Interactive spare-parts catalogues
- Repairs on electronic parts, glue tanks and electro-spindles



DIGITAL SERVICES

- Maestro Connect - IoT platform to be constantly connected with your machines
- Smartech - assistance with augmented reality
- My Scm portal - opening of service ticket and single point of access to the apps and Services tools

THE STRONGEST WOOD ARE IN OUR DNA

SCM. A HERITAGE OF SKILLS IN A UNIQUE BRAND

70 years of success gives SCM the centre stage in woodworking technology. This heritage results from bringing together the best know-how in machining and systems for wood-based manufacturing. SCM is present all over the world, brought to you by the widest distribution network in the industry.

70 years history

3 main production sites in Italy

300.000 square metres of production space

20.000 machines manufactured per year

90% export

20 foreign branches

400 agents and dealers

500 support technicians

500 registered patents

In SCM's DNA also strength and solidity of a great Group. The SCM Group is a world leader, manufacturing

SCM GROUP, A HIGHLY SKILLED TEAM EXPERT IN INDUSTRIAL MACHINES

INDUSTRIAL MACHINERY

Stand-alone machines, integrated systems and services dedicated to processing a wide range of materials.



WOODWORKING TECHNOLOGIES



TECHNOLOGIES FOR PROCESSING
COMPOSITE MATERIALS, ALUMINIUM,
PLASTIC, GLASS, STONE, METAL

TECHNOLOGIES



industrial equipment and components for machining the widest range of materials.

AND COMPONENTS

INDUSTRIAL COMPONENTS

Technological components for the Group's machines and systems, for those of third-parties and the machinery industry.

HITECO

SPINDLES AND TECHNOLOGICAL
COMPONENTS

es

ELECTRIC PANELS

steelmec

METALWORK

scmfonderie

CAST IRON



SCM GROUP SPA
via Casale 450 - 47826 Villa Verucchio, Rimini - Italy
tel. +39 0541 674111 - scm@scmgroup.com
www.scmwood.com



00L0380033A