

morbidelli m100/m200

numerical controlled machining centres



THE AFFORDABLE ALL-IN-ONE TECHNOLOGY

UNDERSTAND THE NEEDS TO BE...



... ALL RESPONSIVE



**EVERYTHING
YOU ALWAYS
DREAMED OF A
CNC MACHINING
CENTRE BUT
WERE TOO
AFRAID TO ASK**

FREEDOM

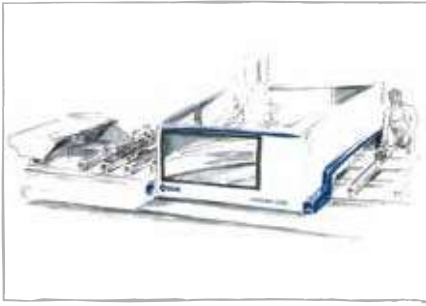

Optimizing the space in your factory thanks to the PRO-SPACE solution.

Accessible and ergonomic 360° all around, no floor obstructions: all the components are within the base.

Total safety and freedom to load large panels (as wide as 2200 mm) due to the work table being entirely accessible.

TOP QUALITY

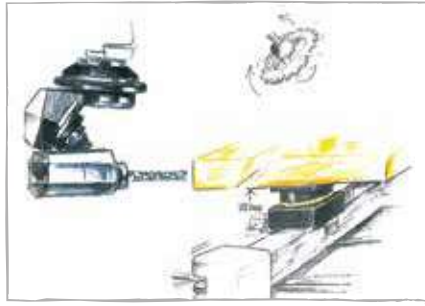

Unique to the market: up to 4 types of units to fit different working groups.

Unrivalled finishing with new direct drive **JQX (Just Quality eXtreme)** 5-axis electrospindle.

Reduced maintenance, thanks to the **RO.AX (Rotoaxial spindle technology)** drilling bits. It is recommended only after more than 1000 hours of work.

60% of time saved on drilling cycles with the new drill-bits designed to guarantee the best effectiveness on all types of material.

FASTER

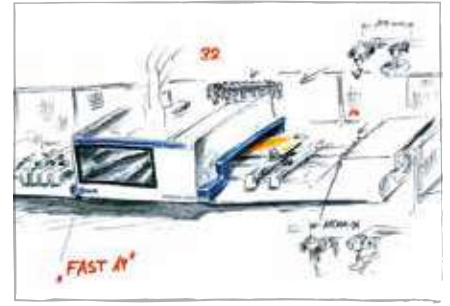

Beyond imagination, up to 60 tools always available on board make the machine the best in its class.

Less than 15" for the tool change with the 14 position **FAST** tool changer.

ALL

FLEXIBLE

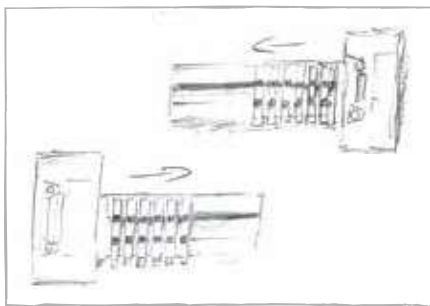

From panel to furniture, from kitchen doors to windows. The right solution configured for all your needs and your investment plan.

Zero idle times for set-up operations and no compromise for the machine performance with the versatility and free configurability of the **TV FLEXDRIVE** and **TV FLEXMATIC** work tables.

No limit for the work piece machining with thickness up to 180 or 250 mm on 75 mm vacuum pods.

Maximum integration with Cargo system for the automatic loading and unloading of panels.

CLEAN

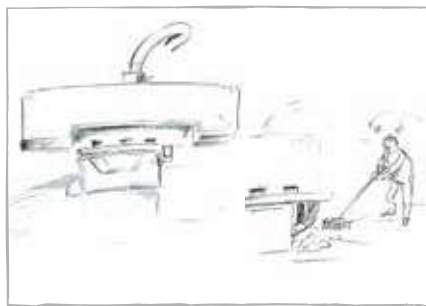

No problem with dust or shavings thanks to the intelligent solution of the dust collection box located in an ergonomic position.

Free space on the floor with the vacuum pump integrated in the machine base.

READY



1 technician, 1 day and the machine is up and running!

44

MAESTRO software

46

Technical data

100 REASONS TO BUY, 200 REASONS

EXCLUSIVE FEATURES

9



All at your fingertips thanks to the TECPAD 7" colour remote control with touch-screen.

10

Free access, having the cable-holder chain enclosed within the machine frame.

11



Rapid working cycles with the 14 position FAST tool changer.

8

Intuitiveness and easiness with the APPS included in the Maestro software for the production of doors, stairs, furniture and furnishing elements.

7

Integrated electrical cabinet with air conditioner.

6¹

Zero idle times for set-up operations and no compromise for the machine performance with the versatility and free configurability of the TV FLEXDRIVE and TV FLEXMATIC work tables.

TO ENJOY

morbidelli m100/m200

numerical controlled machining centres

12



Wide availability of tools thanks to the TRC rear chain tool changer with 32 positions.

1



- Total flexibility with an operating group configurability unique to the market.
- Unrivalled finishing with new direct drive JQX (Just Quality eXtreme) 5-axis electrospindle.
- 60% of time saved on drilling cycles with the new drill-bits designed to guarantee the best effectiveness on all types of material.
- Reduced maintenance, thanks to the RO.AX (Rotoaxial spindle technology) drilling bits. It is recommended only after more than 1000 hours of work.

2



TRB tool changer with 14 positions.

3



Free space on the floor with the vacuum pump integrated in the machine base.

5

100% of the working area covered by all the units of the operating group.

6²



Very high flexibility with the multi-function work table made of extruded aluminium, extremely stiff, designed to maintain a perfect planarity over time, even after repeated mechanical stresses; it is ideal also for nesting machining.

4



No problem with dust or shavings thanks to the intelligent solution of the dust collection box located in an ergonomic position.



EVERYTHING YOU ALWAYS DREAMED OF A CNC MACHINING CENTRE BUT WERE TOO AFRAID TO ASK

FREEDOM OF MOVEMENT



ALL FREEDOM

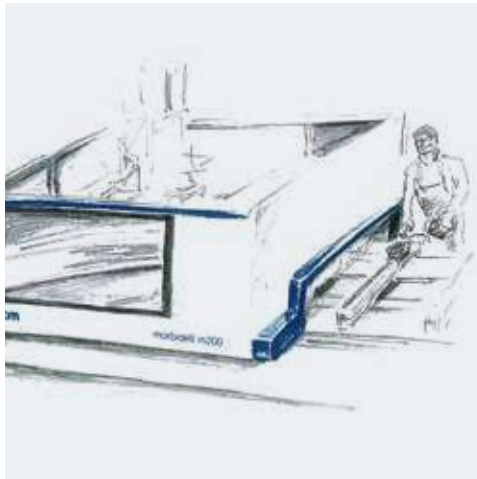

Optimizing the space in your factory thanks to the PRO-SPACE solution.

Accessible and ergonomic 360° all around, no floor obstructions: all the components are within the base.

Total safety and freedom to load large panels (as wide as 2200 mm) due to the work table being entirely accessible.

MINIMUM OVERALL DIMENSIONS MAXIMUM SAFETY AND FLEXIBILITY

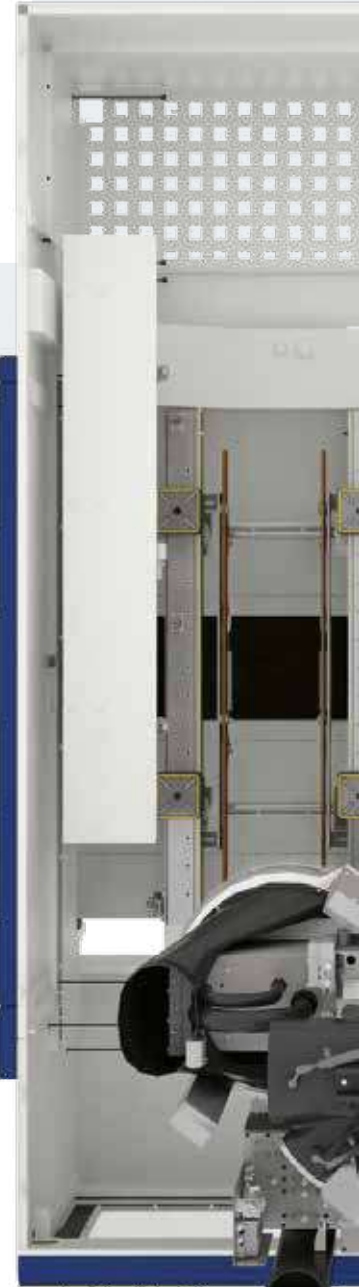

“PRO-SPACE” PROTECTIONS

Loading zone completely free to reduce the space occupied to the minimum.

The absence of perimeter protections facilitates the work table access on all the sides of the machine.

morbidelli m100/m200

numerical controlled machining centres

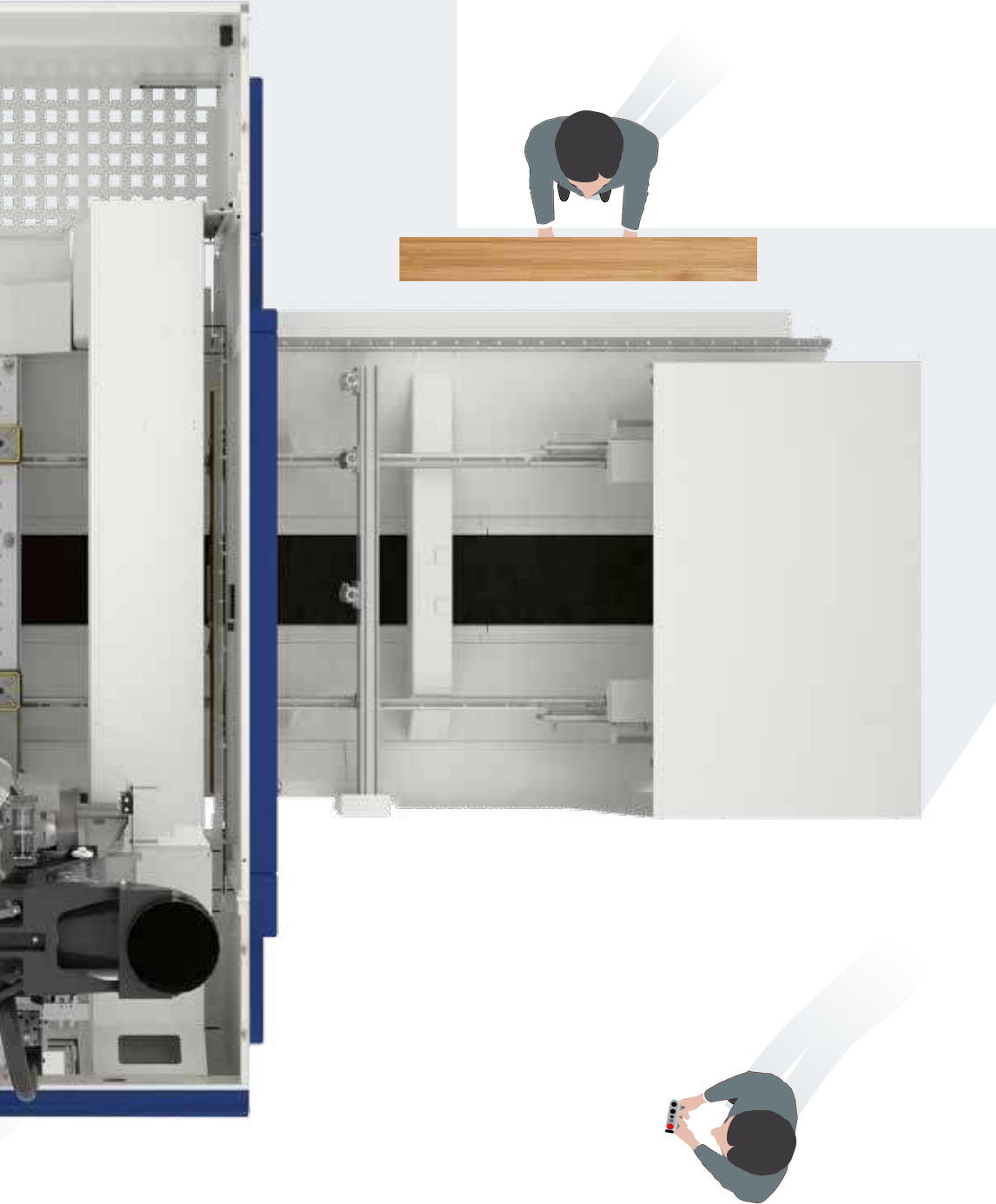

SAFETY SYSTEMS

GUARANTEED SAFETY: BUMPERS PROTECTIONS

Fully safe machining with the bumpers safety system with lock the machine in case of accidental contact with the operator.



MINIMUM OVERALL DIMENSIONS MAXIMUM SAFETY AND FLEXIBILITY: PRO-SPACE PROTECTIONS

Loading zone completely free to reduce the space occupied to the minimum. The protections allow the machine to be used with a feed speed up to 25 m/min in X direction.

The absence of perimeter protections facilitates the work table access on all the sides of the machine.

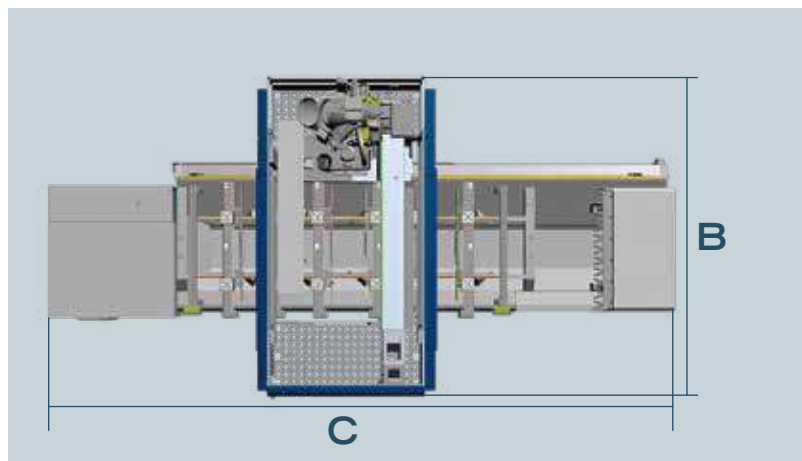

TOTAL FREEDOM AND HIGH PRODUCTIVITY: PRO-SPEED PROTECTIONS

Protection system for the machine use to the maximum speed of 60 m/min. When the operator enters into the loading area, which is delimited by the front photocell barrier, the machine automatically reduces the speed; when the operator leaves the loading area the system restores the maximum speed.

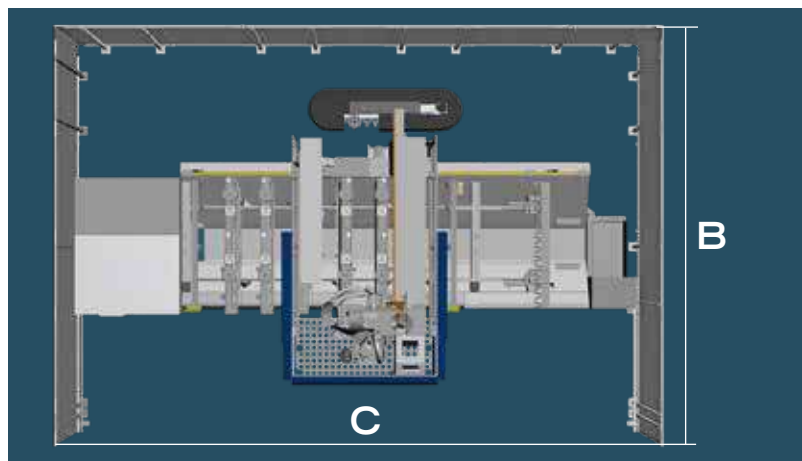

OVERALL DIMENSIONS

morbidelli m100/m200

numerical controlled machining centres

		A	B		C	
			PRO-SPACE	PRO-SPEED	PRO-SPACE	PRO-SPEED
MORBIDELLI M100 WORK TABLE						
Working area 3110 x 1320	mm	2780	3156 (4156*)	4720	6715 (7065*)	7300
Working area 3710 x 1320	mm	2780	3156 (4156*)	4720	7315 (7665*)	7900
Working area 5510 x 1320	mm	2780	3156 (4156*)	4720	9115 (9465*)	9700
Working area 3110 x 1620	mm	2780	3456 (4456*)	5020	6665 (7015*)	7300
Working area 3710 x 1620	mm	2780	3456 (4456*)	5020	7265 (7615*)	7900
Working area 5510 x 1620	mm	2780	3456 (4456*)	5020	9065 (9415*)	9700
MORBIDELLI M200 WORK TABLE						
Working area 3110 x 1620	mm	2820	3562 (4562*)	5020	6670 (7020*)	7300
Working area 3710 x 1620	mm	2820	3562 (4562*)	5020	7270 (7620*)	7900
Working area 5510 x 1620	mm	2820	3562 (4562*)	5020	9070 (9420*)	9700

* It includes the operating area

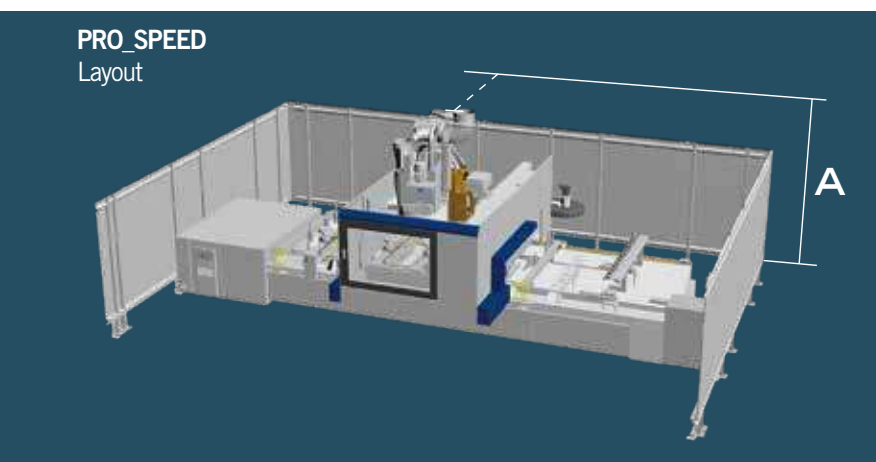
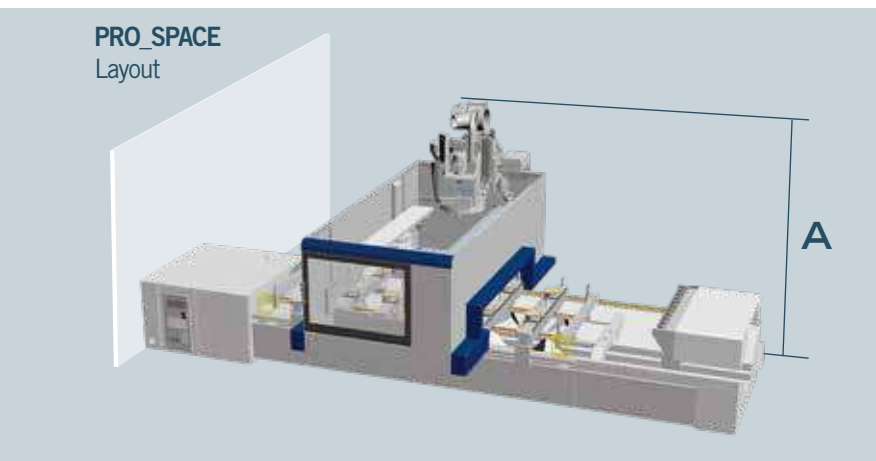

5 AXES AT HAND



ALL TOP QUALITY

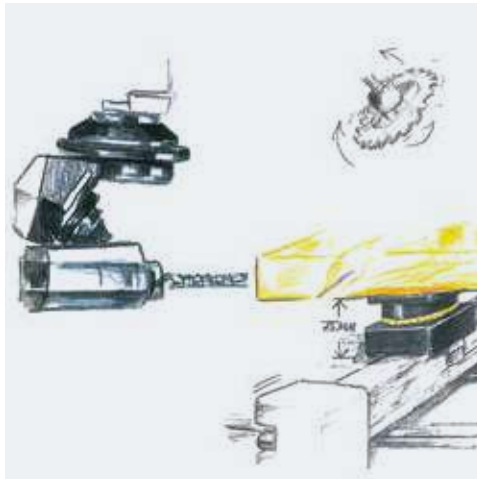

Unique to the market: up to 4 types of units to fit different working groups.

Unrivalled finishing with new direct drive **JQX** (Just Quality eXtreme) 5-axis electrospindle.

Reduced maintenance, thanks to the **RO.AX** (Rotoaxial spindle technology) drilling bits. It is recommended only after more than 1000 hours of work.

60% of time saved on drilling cycles with the new drill-bits designed to guarantee the best effectiveness on all types of material.

MACHINING UNIT: DRILLING UNIT

The higher drilling capacity in its category: up to 21 vertical spindles, 12 horizontal spindles and an independent blade unit.
60% of time saved on drilling cycles with the drill-bits designed to guarantee the best effectiveness on all types of material.

INDESTRUCTIBLE AND WITH LOW MAINTENANCE

The sturdiness of drilling heads is proven by the reduced maintenance costs: it is recommended only after more than 1000 hours of work.

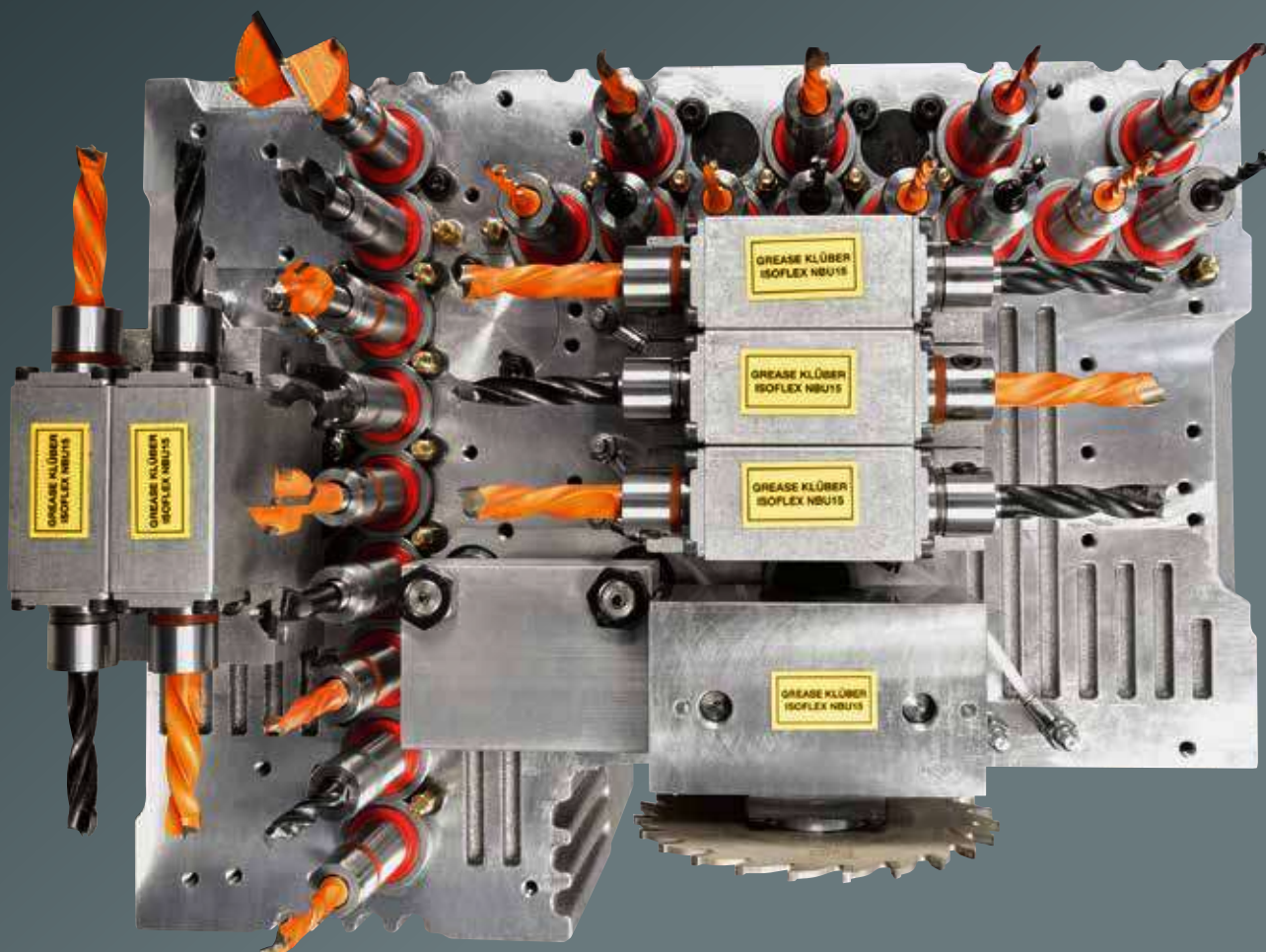



EVEN MORE PERFORMING

The drilling unit can be provided with an independent Z-axis, allowing the tool change in hidden time.



THE PERFECT DRILLING



RO.AX SPINDLE

Zero play during machining with the new RO.AX technology (Rotoaxial spindle technology), the most efficient spindle on the market with rotation speeds up to 8000 rpm.

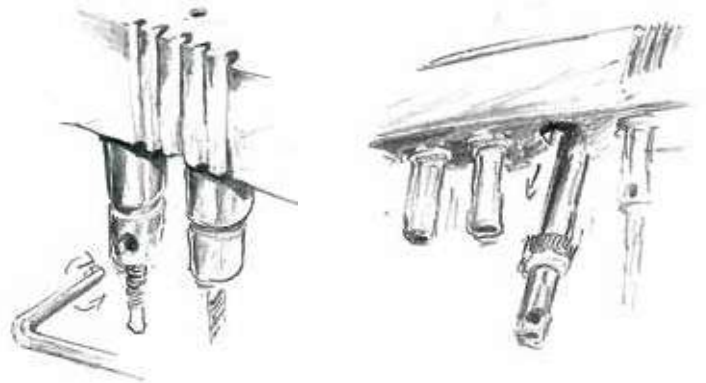

High performance drilling units thanks to the spindles with innovative design. The new drilling spindle offers optimal solutions to achieve the highest quality of finishing and the maximum speed of the whole execution:

- **more than 50% increase in rigidity:**
rod spindle diameter from 20 mm
- **reduction of vibrations and guaranteed drilling quality on all materials:**
rod spindle guide system with special roll bearings
- **lower operation noise and more rigidity:**
absence of radial friction between spindle and rotating bearings
- **reduced maintenance costs:** new system to disassemble the spindle
- **more reliability:** less components employed



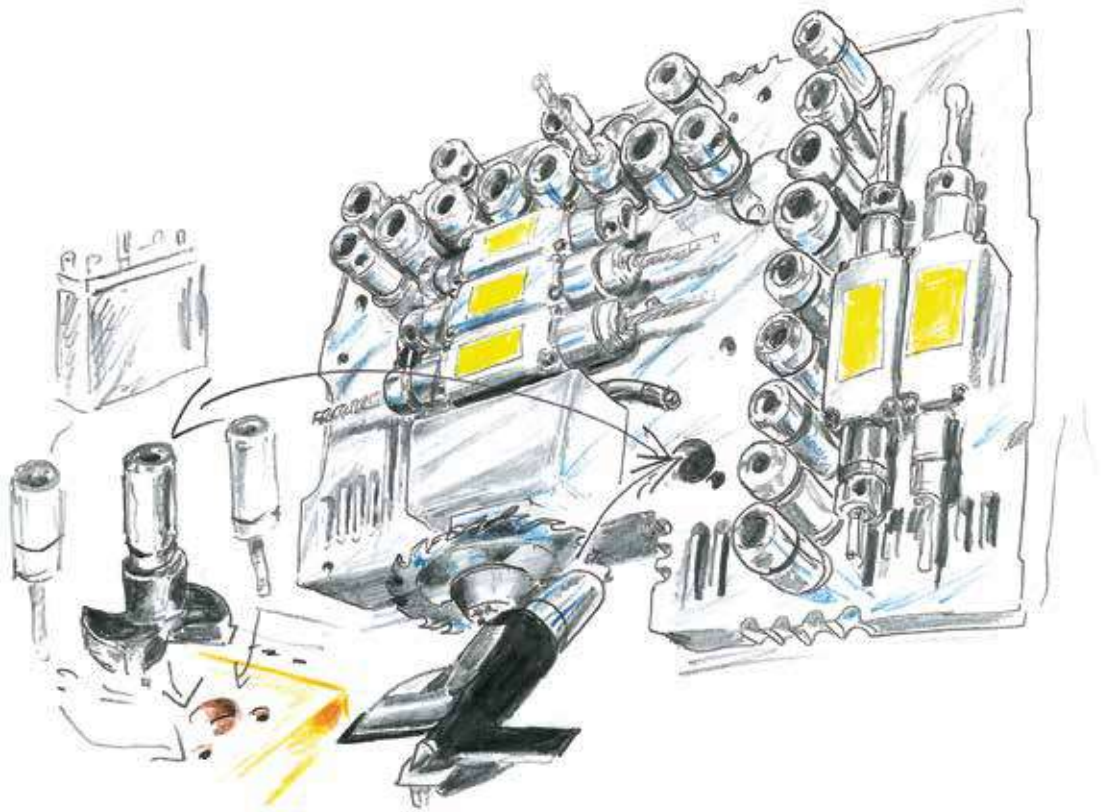

**HINGE DRILLING:
ONE STEP WORTH THREE!**

Possibility to carry out 3 simultaneous drillings with a single head integrated in the main drilling unit.

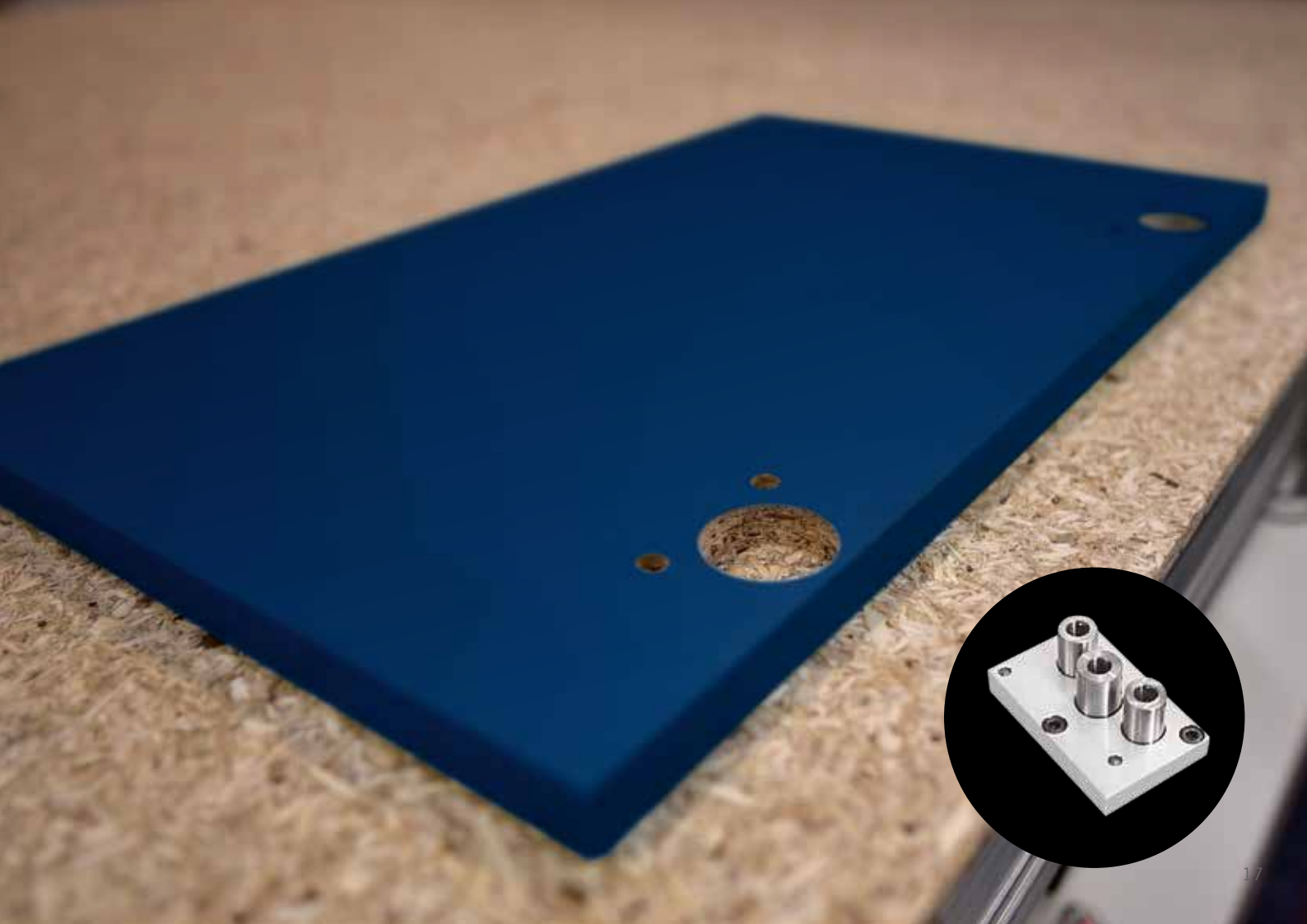

UNIVERSAL, HIGH SPEED ROTATION

TO PRODUCE OBJECTS
WITH ANY KIND
ON SHAPE ON ANY
KIND OF MATERIAL

JQX ELECTROSPINDLE

Very high finishing quality with the **JQX** (Just Quality eXtreme) 5-axis electrospindle, with direct drive and up to 12 kW power, which ensures total absence of vibrations even with large material removals at high speeds. The lightweight structure and the excellent price/quality ratio make this electrospindle ideal for those looking for a flexible and practical product but with high level performance.

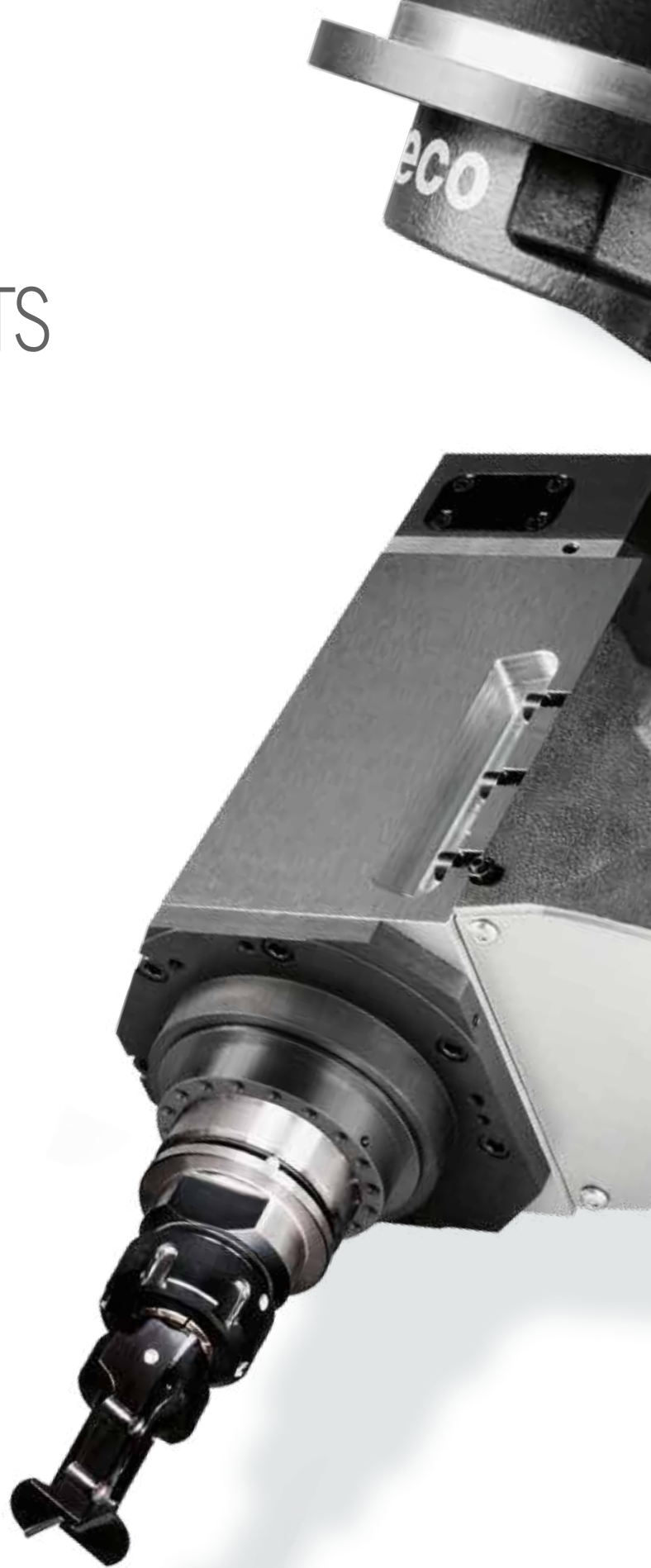

morbidelli m100/m200

numerical controlled machining centres

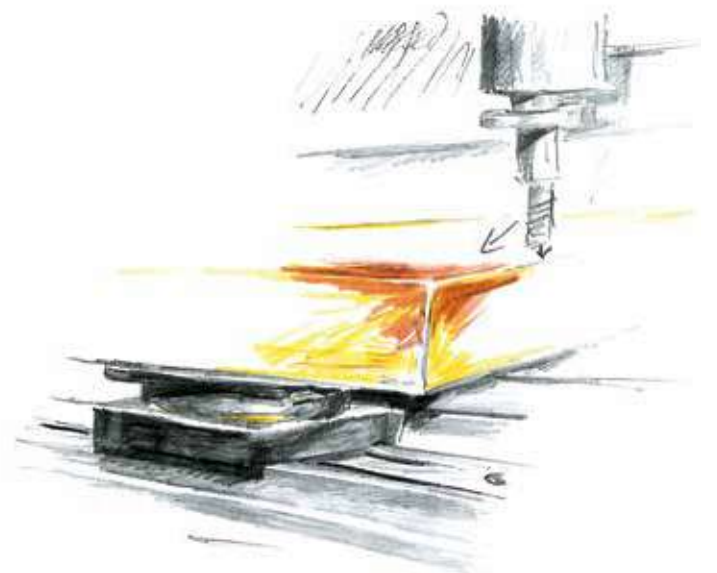

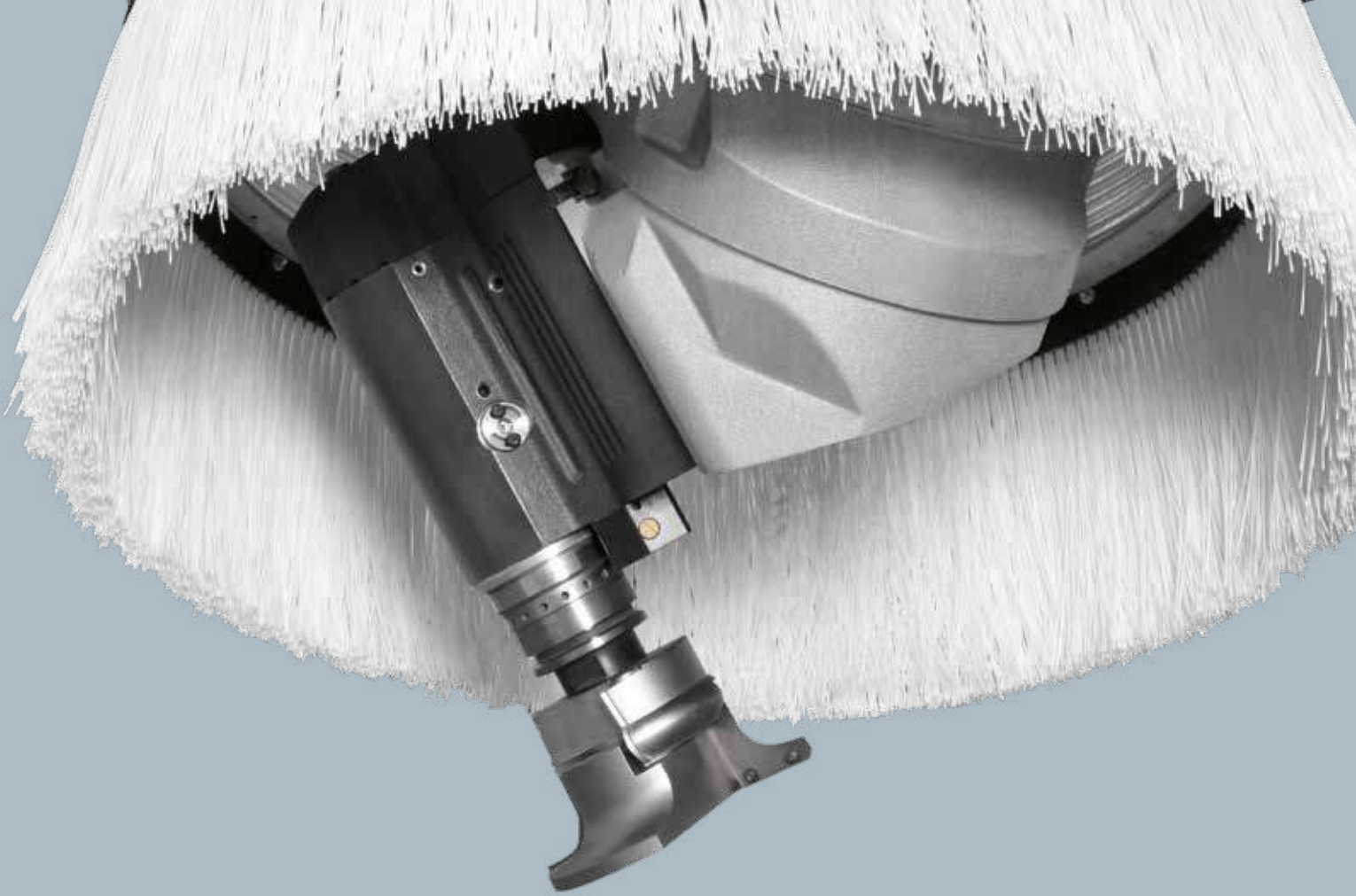

POWERFUL AND COMPACT: PRISMA KT/KS ELECTROSPINDLE

High performance with Prisma KT and KS electrospindles, the top in its category in terms of power and torque at all RPMs. High quality finish even on heavy machining with the exclusive TTS (Total Torque System) locking system, that provides the spindle with the rigidity of a 3-axis unit.

SUPERIOR TECHNOLOGY FOR MACHINING WITH 5 AXES:

PRISMA ELECTROSPINDLE

Reduced maintenance, maximum flexibility and optimal finishing quality with the BEL.TECH technology (Belt technology system), the belt transmission system which eliminates vibration and heat from tools to the motor. This system (in use on the spindle for machining metals) due to the compact structure, allows easy operations in limited spaces.

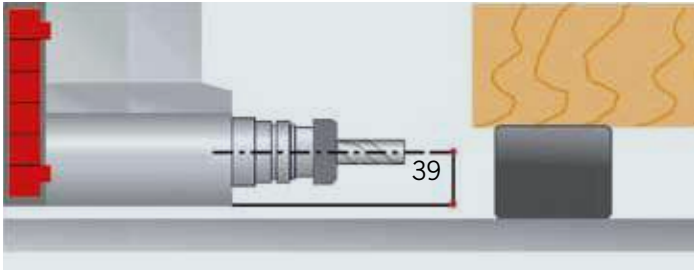

5-axis machining unit geometry allows it to operate at angles of up to 10° below the work piece supporting surface.

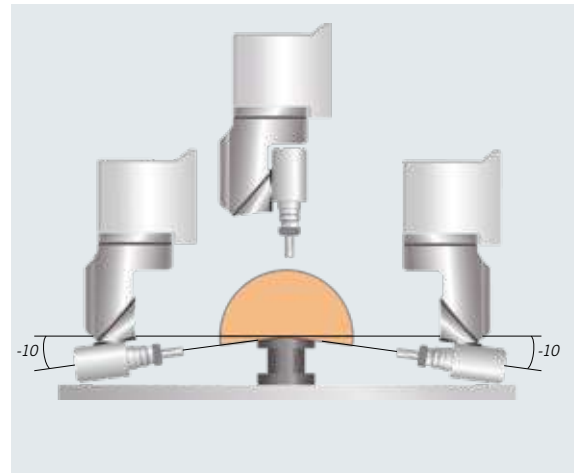



Optimal machining precision with the 3-axis electrospindle up to 24.000 rpm.

Easy grooves machining on the sides of the furniture thanks to the integrated blade unit.

Production of doors and other horizontal machining that require heavy duty routing (grooves, hinge or lock recesses), with high precision and speed, by means of the two outlet horizontal spindle.

Higher efficiency and working time reduction with the 4,5 kW additional routing unit.

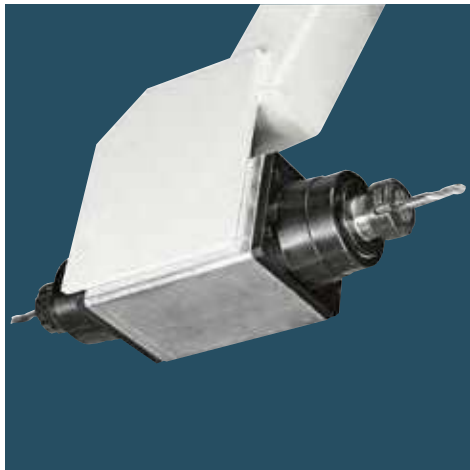

DRILLING AND DOWELLING IN A SINGLE OPERATION: HI. LOCK DEVICE

Work pieces finished and ready for the assembling with the HI. LOCK (High locking system) dowel insertion unit, the device that can manage the insertion of dowels on a machining centre.

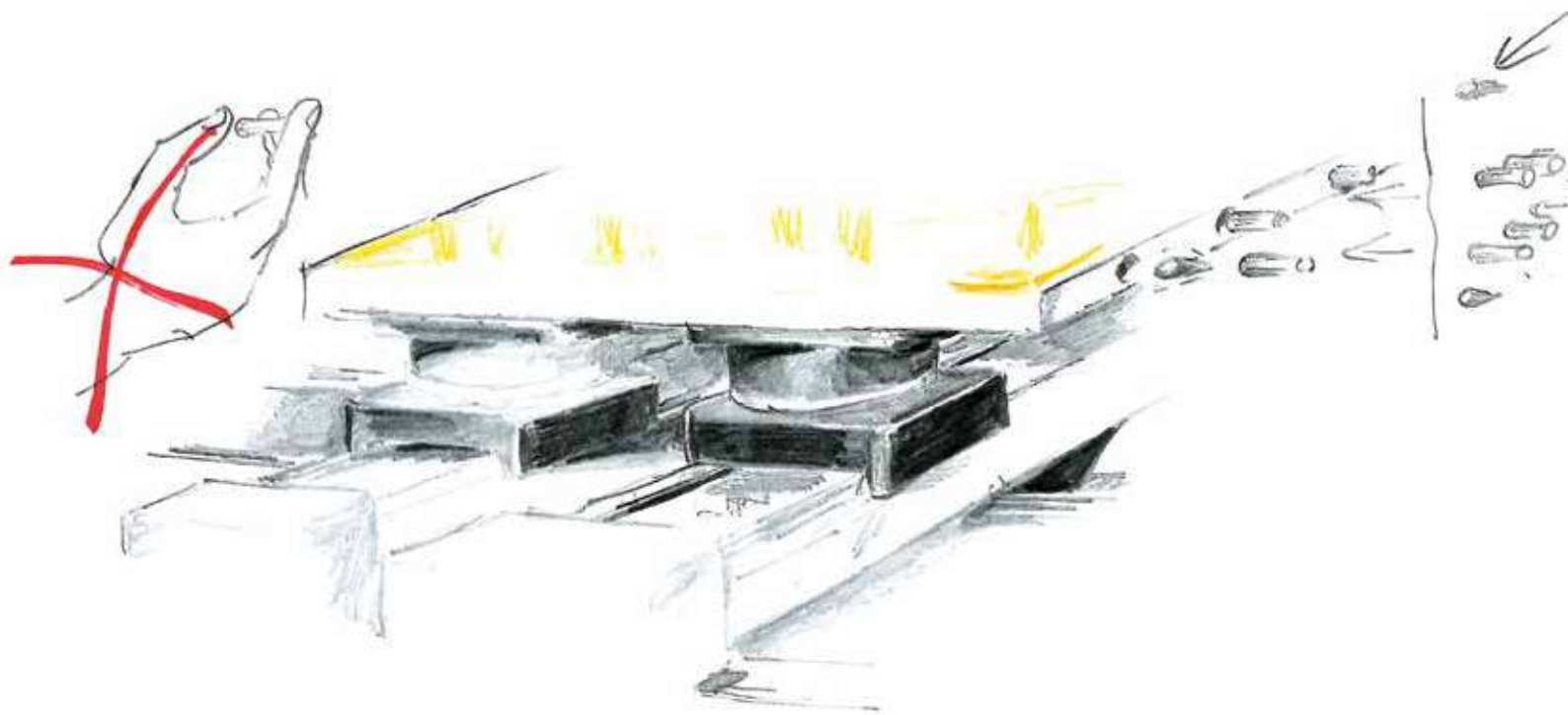

Optimization of productivity with no more time wasting for cleaning operations, thanks to the use of glue capsules, contrary to traditional dowelling devices where it is necessary to remove the remaining drying glue from the various components after a temporary production-stop.

Glue capsule



REDUCTION OF WORKING TIMES

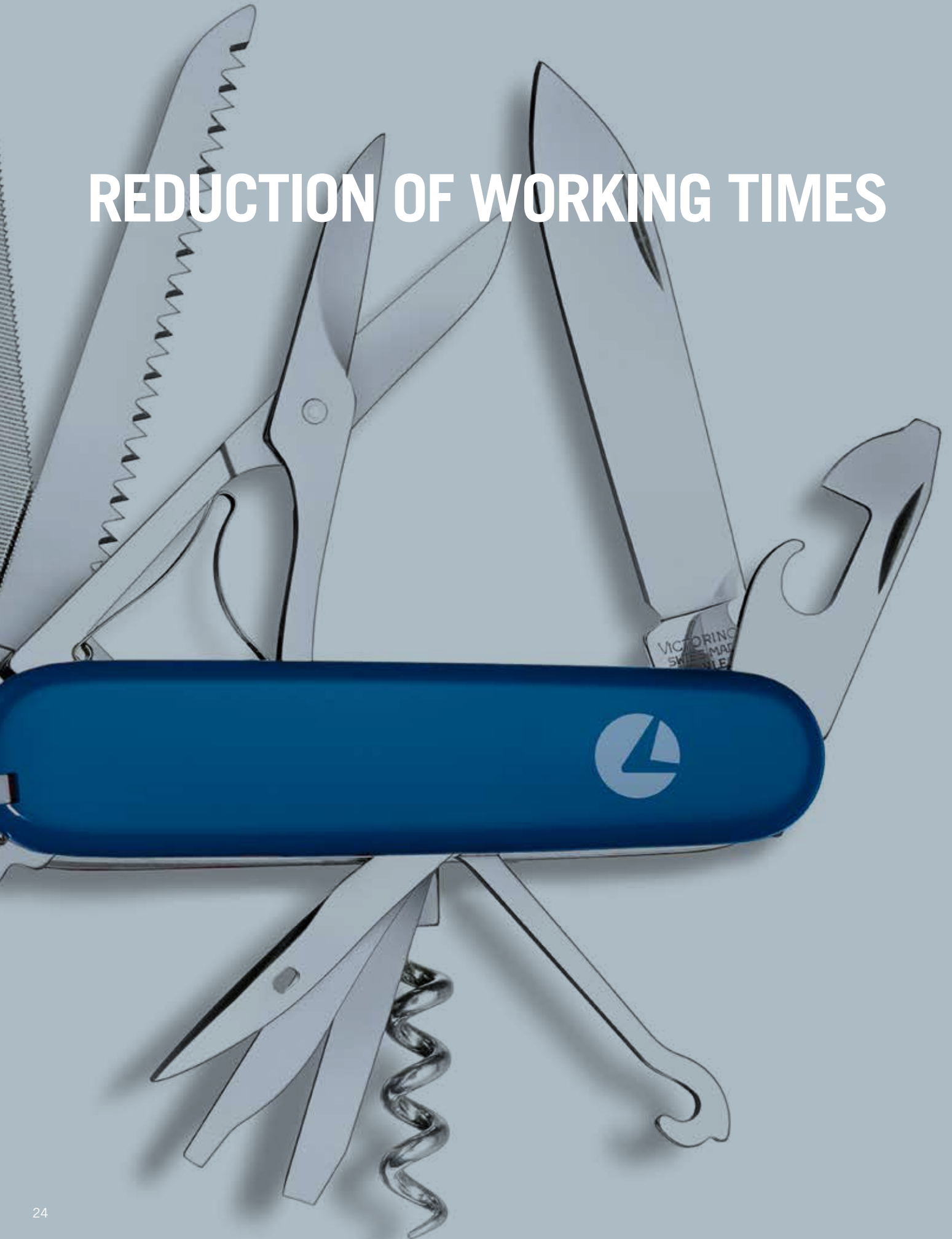

ALL FASTER

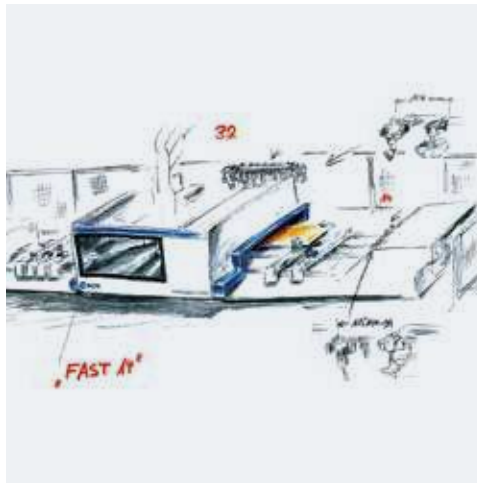

Beyond imagination, up to 60 tools always available on board make the machine the best in its class.

Less than 15" for the tool change with the 14 position **FAST** tool changer.



ALL AT YOUR SPINDLE FINGERTIPS!

UP TO 60 TOOLS ALWAYS AVAILABLE ON BOARD
MAKE THE MACHINE THE BEST IN ITS CLASS

NO IDLE TIME for the tool change from a machining process to another one with the 14 position **FAST** tool changer.

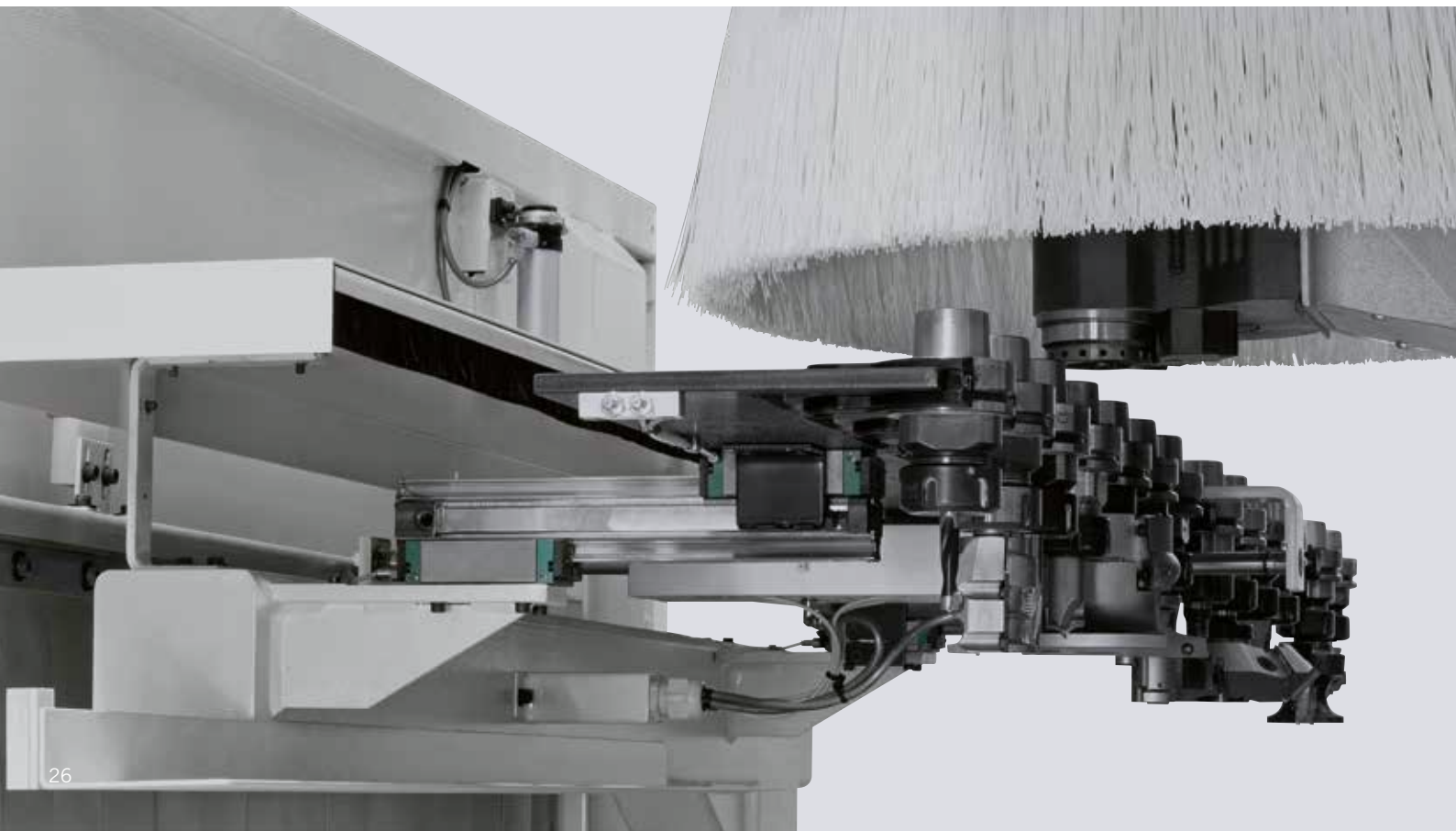

morbidelli m100/m200

numerical controlled machining centres



The **"VELOCE"** on-board tool changer with 12 or 16 positions, equipped beside the electrospindle, allows the tool change in hidden time.
It is also available with the additional **"pick-up"** for saw-blade.

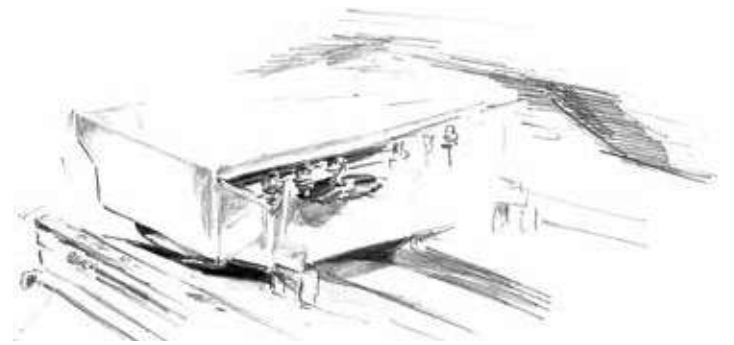

Wide range of tools available to the operator with the rear tool changers up to 32 positions.



TRB side tool changer with 11 or 14 positions.



EVERYTHING YOU ALWAYS DREAMED OF A CNC MACHINING CENTRE BUT WERE TOO AFRAID TO ASK

INIFINITE WAYS OF BEING

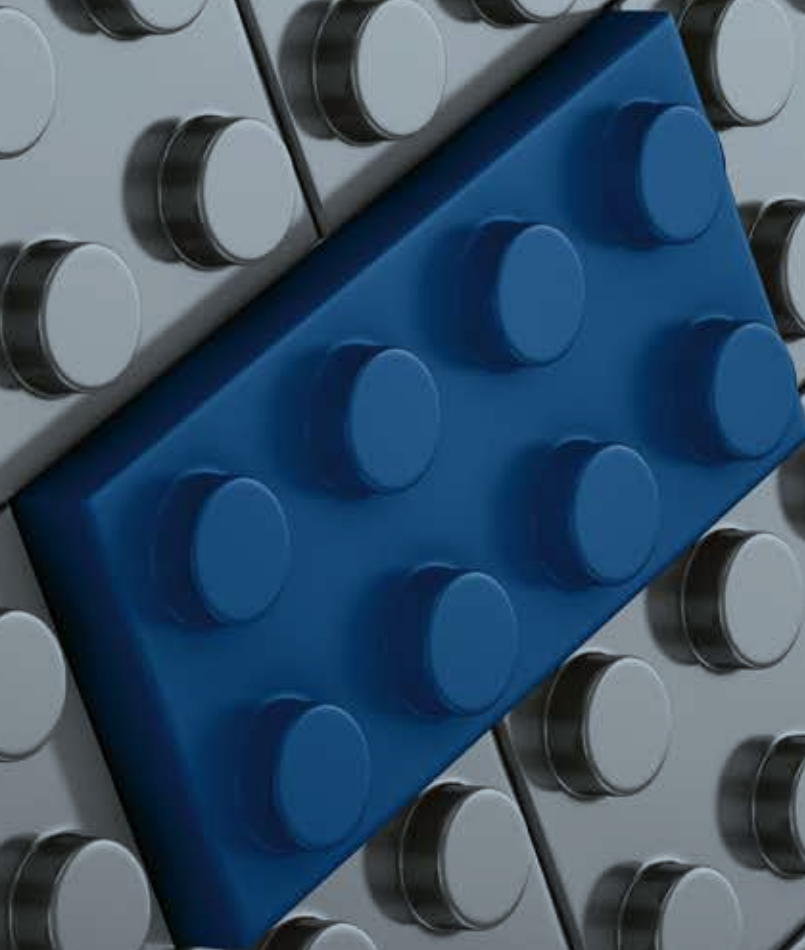

ALL FLEXIBLE

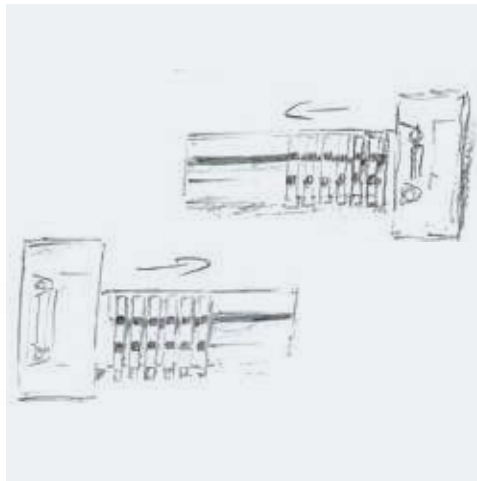

From panel to furniture, from kitchen doors to windows. The right solution configured for all your needs and your investment plan.

Zero idle times for set-up operations and no compromise for the machine performance with the versatility and free configurability of the **TV FLEXDRIVE** and **TV FLEXMATIC** work tables.

No limit for the work piece machining with thickness from 180 and 250 mm on 75 mm vacuum pods.

Maximum integration with Cargo system for the automatic loading and unloading of panels.

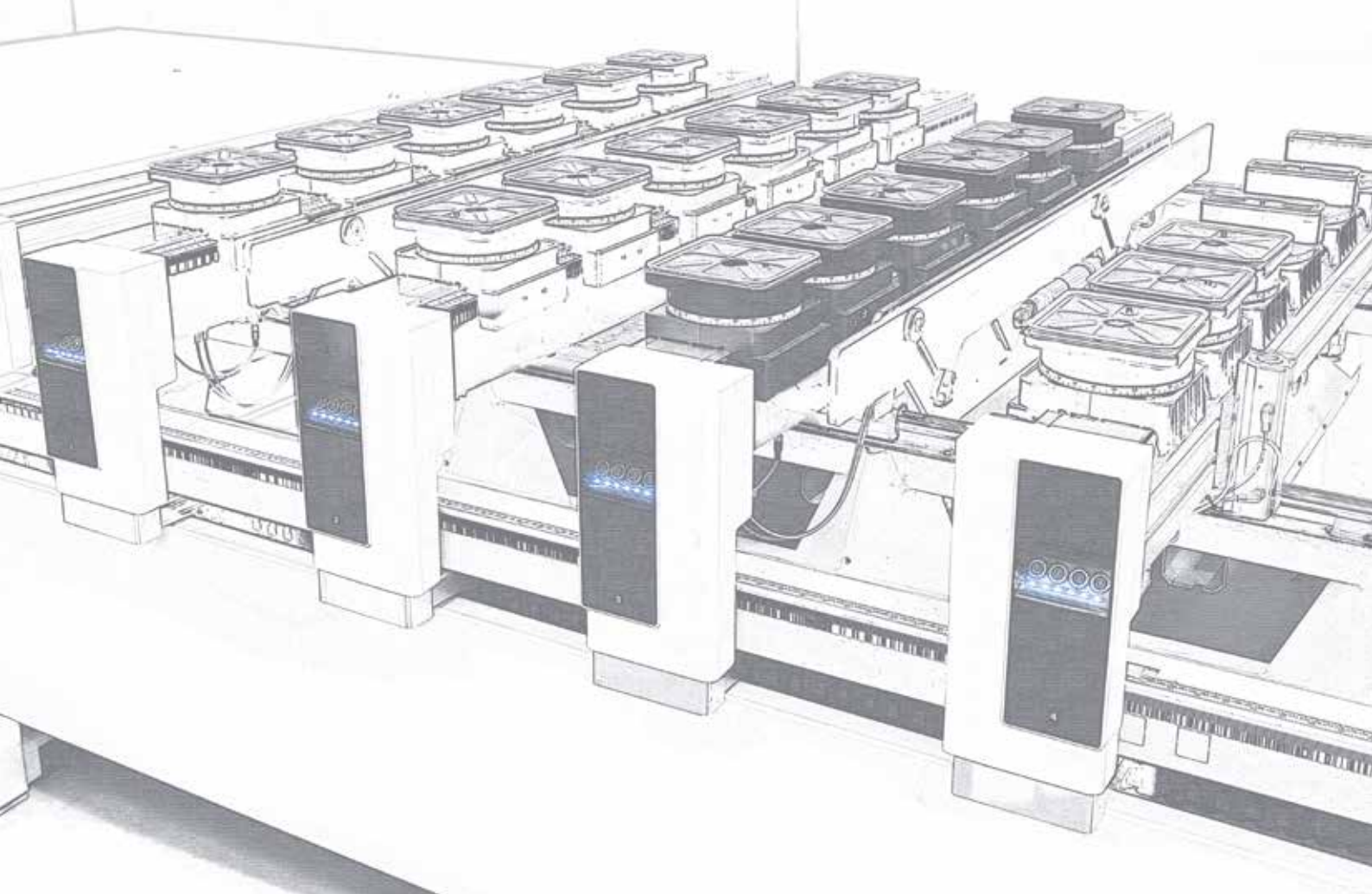

RELIABLE, FAST AND USER FRIENDLY: **FLEXDRIVE WORKTABLE**

Thanks to an innovative positioning technology, **FLEXDRIVE** allows to manually set up a work table through LED light indicators positioned both on bars and locking systems.

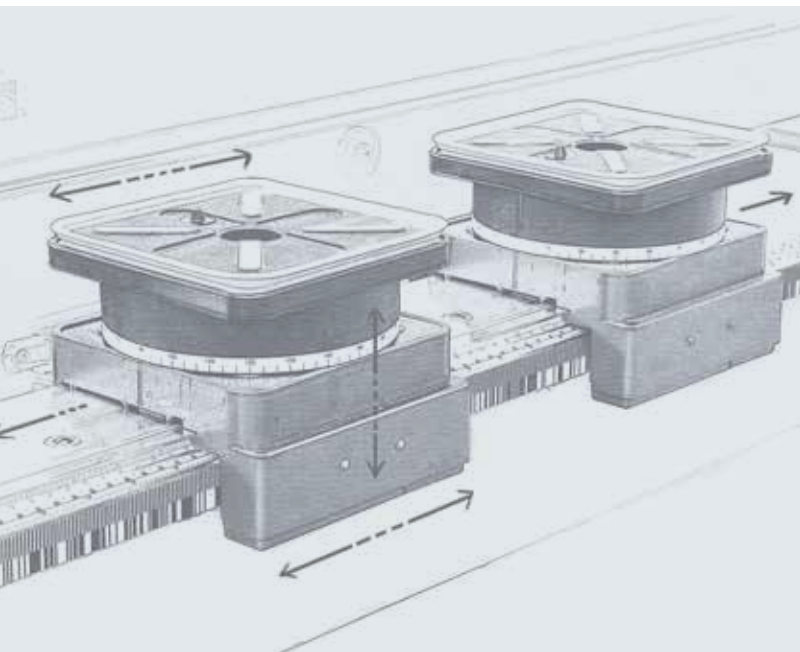

- **Reliable.** No mistakes in the locking systems positioning thanks to the automatic verification: if the set-up is not correct, the program won't start.
- **Fast.** Minimized set-up times thanks to the lights that guide the operator by indicating the exact position of the bars and locking systems (pods and clamping devices).
- **User friendly.** There is no need for an expert operator: LEDs make the machine intuitive and easy to set.

morbidelli m100/m200

numerical controlled machining centres

REMOVE



- Bar with central red LED: one or more locking systems must be removed.
- Locking systems with fixed red LEDs: locking systems to be removed.

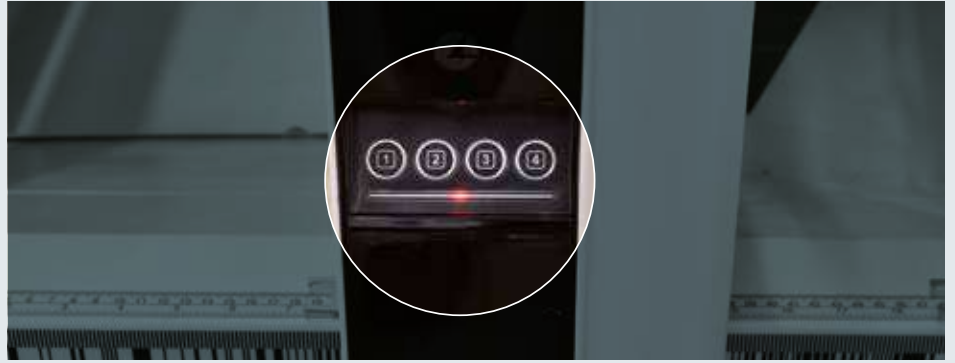

ADD



- Bar with central blue LED: one or more locking systems must be added.



MOVE



- The fixed green LEDs start flashing more and more as the correct bar position is approached. When the target position is reached, the blue strip on the bar lights up.

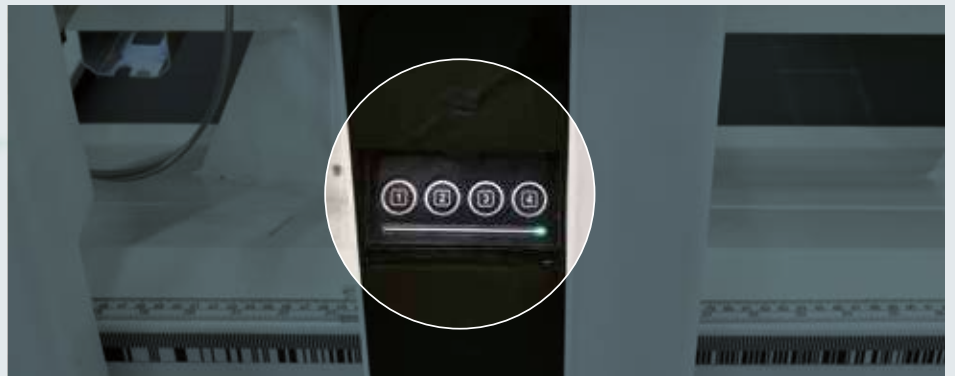

- Locking systems work in the same way: when the target position is reached, the double green LED lights up.

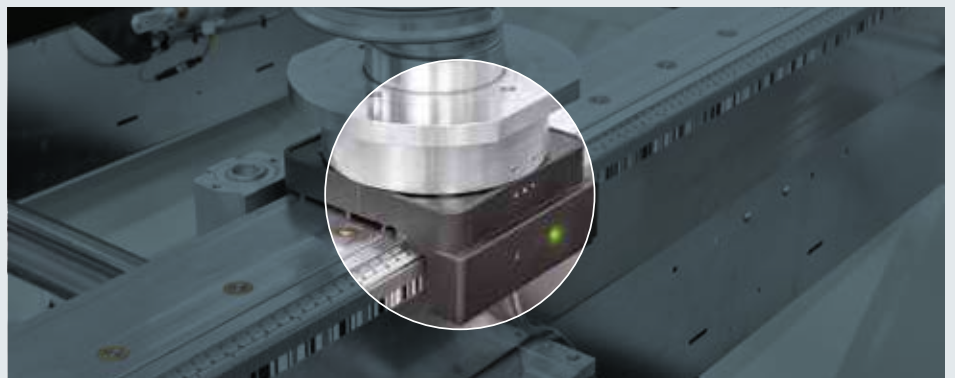

COMPLETED SET-UP



When the set-up is finished, LEDs of both locking systems and bars set to "completed" status:

- Bars: Blue LEDs
- Locking systems: LEDs off



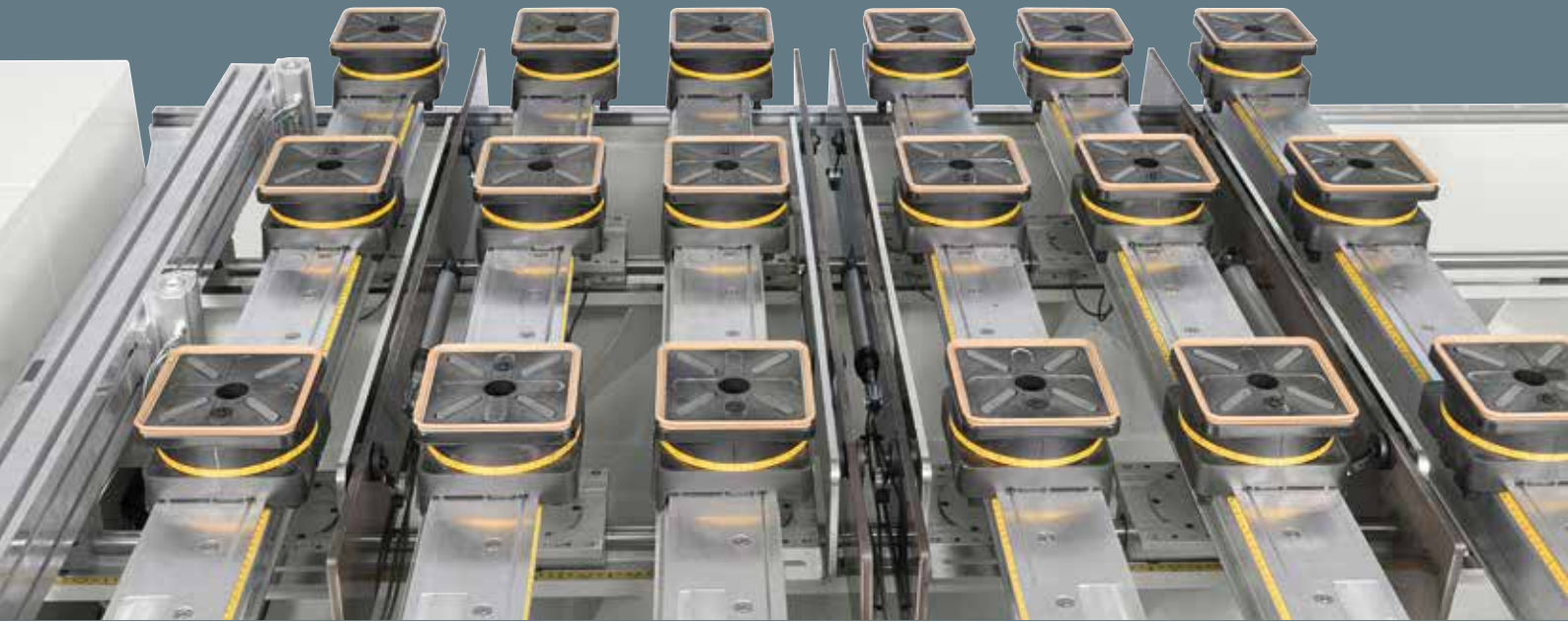

TOTAL CUSTOMISATION: TV FLEXMATIC RAILS WORK TABLE

Automatic work table that allows the management up to 6 vacuum pods on a single rail, according to the dimensions and shape of the work piece to be machined, in order to always have the best holding without risks of collision.

Available also with manual version (**TV FLEX**).

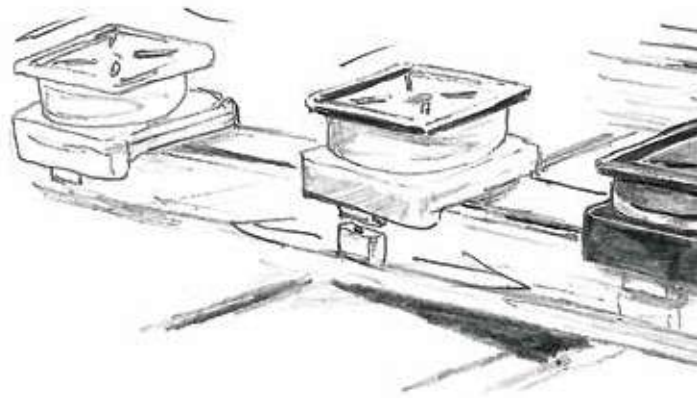

morbidelli m100/m200

numerical controlled machining centres



It is possible to add or remove vacuum pods or clamps with a simple movement of the hand; the number and the position are automatically detected.

No problem for the sliding of vacuum pods or clamps thanks to the blowers positioned along the whole rail that guarantee a constant cleaning.

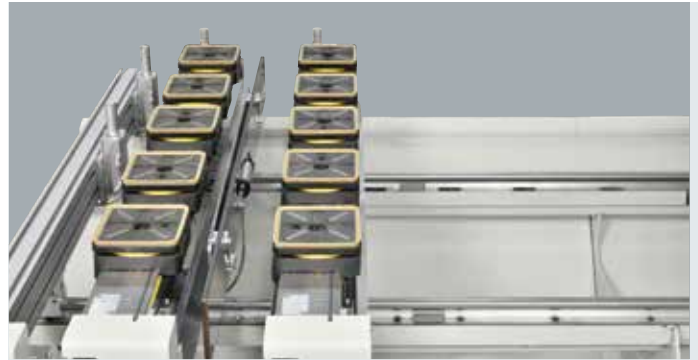
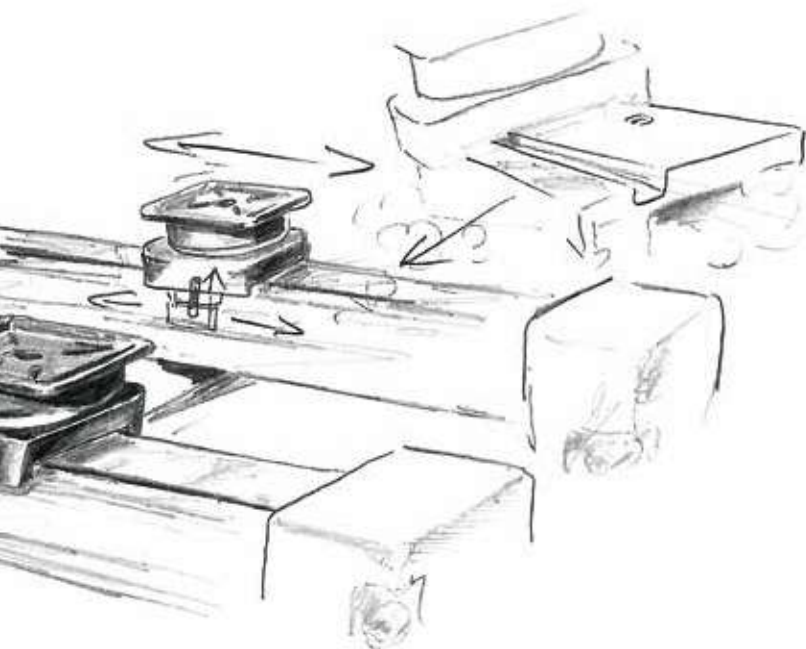

From a single panel can be obtained more elements and automatically re-position them to carry out all machining without interrupting the production cycle; at the end the work pieces are returned to the initial position to facilitate the unloading from the work table.

TV FLEXMATIC RAILS WORK TABLE

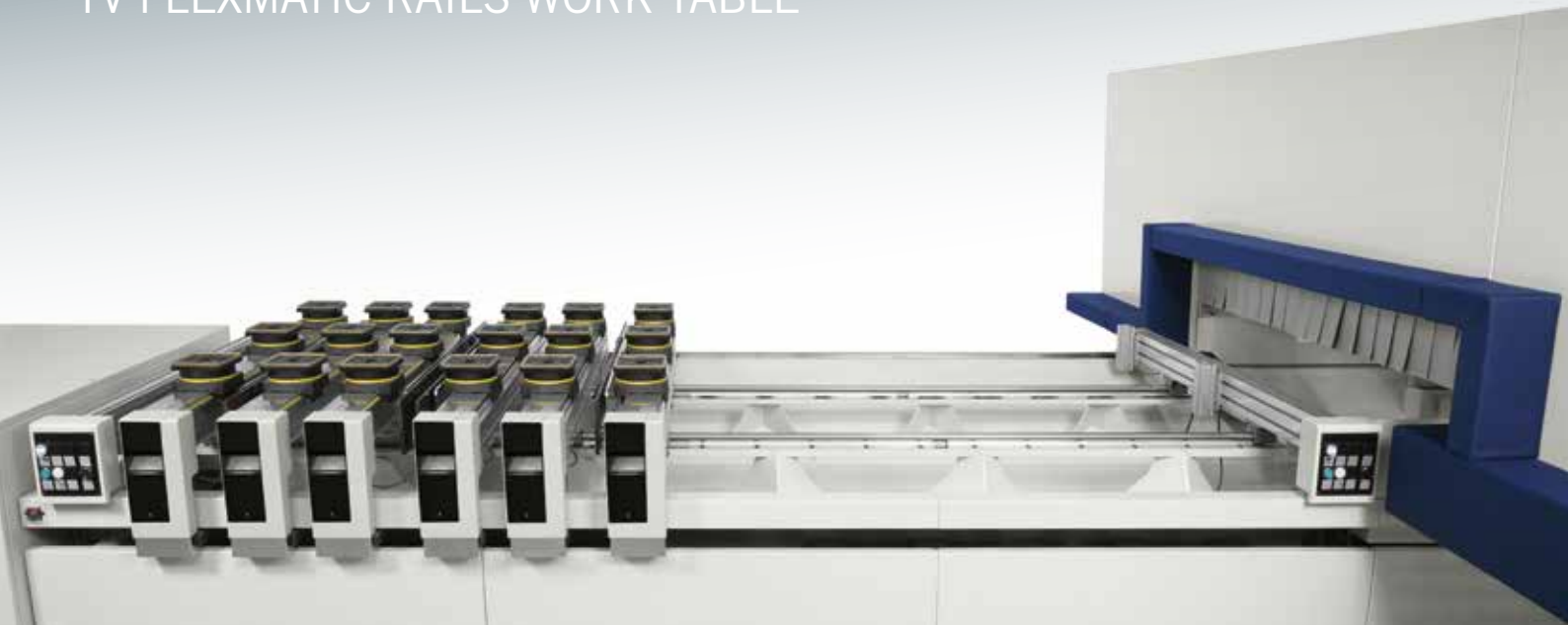

NO LIMITS ON RAILS POSITIONING: TOTAL COVERAGE OF THE WORK TABLE

IDEAL FOR LARGE SIZE PANELS

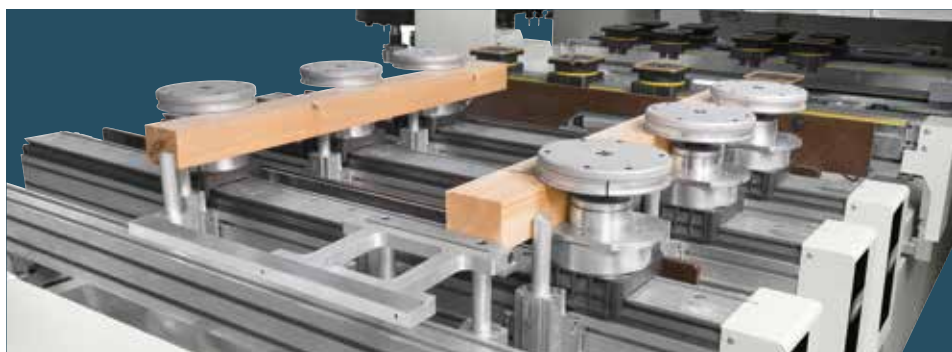

Simple and quick work table set-up also for the manual version.



morbidelli m100/m200

numerical controlled machining centres

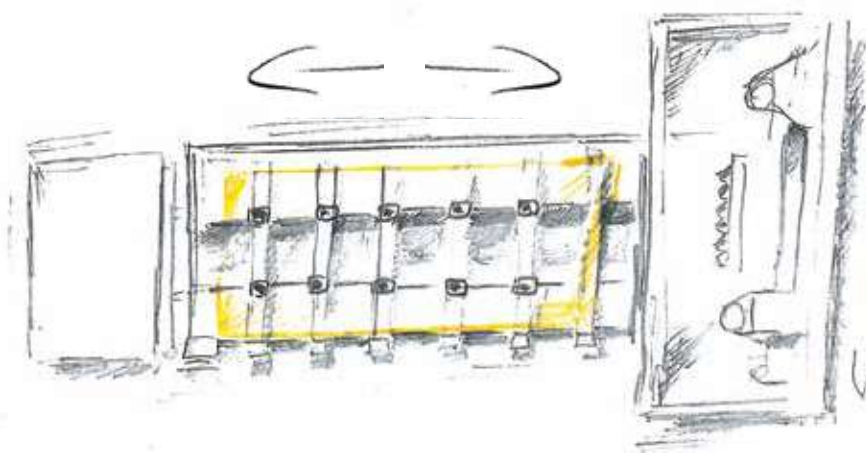
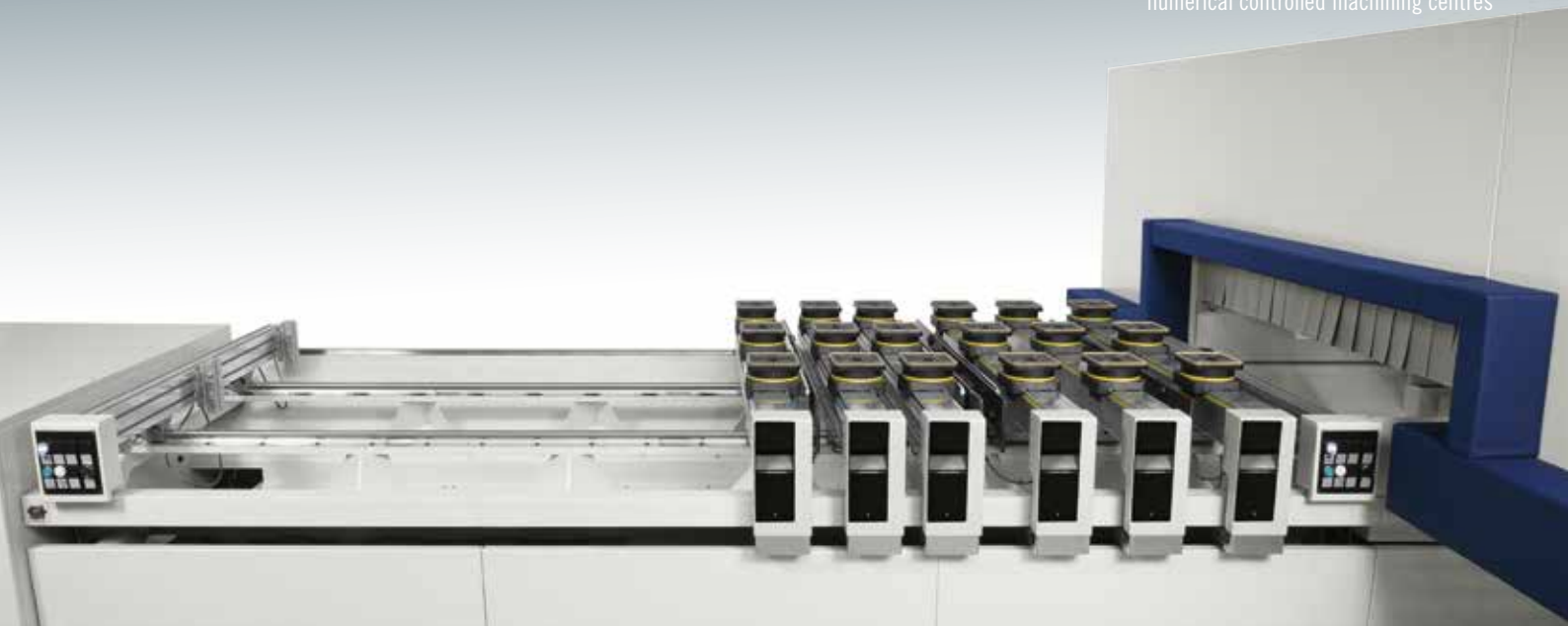

Comfortable pushbutton to have at your fingertips all the necessary commands for the programs execution.



Easy positioning of heavy work pieces and large panels with the lifting support.



VERY HIGH FLEXIBILITY: MULTI-FUNCTION WORK TABLE

Extremely stiff work table made of extruded aluminium, designed to maintain a perfect planarity over time, even after repeated mechanical stresses. It is ideal also for nesting machining.

Optimal work piece holding with the high capacity vacuum up to 1200 m³/h (50 Hz).

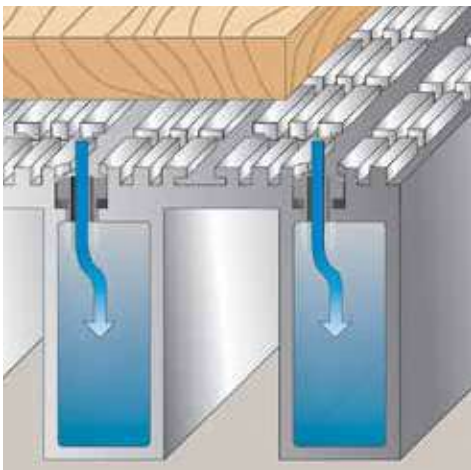

morbidelli m100/m200

numerical controlled machining centres

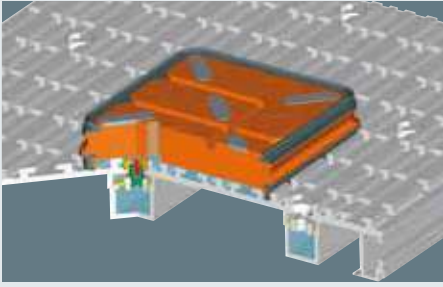

Easy and quick positioning of locking accessories such as MPS vacuum pods and the practical MODULSET system with the surface channels structure.

It is possible to fix custom references thanks to the exclusive "T-shaped" grooves available on the work table.

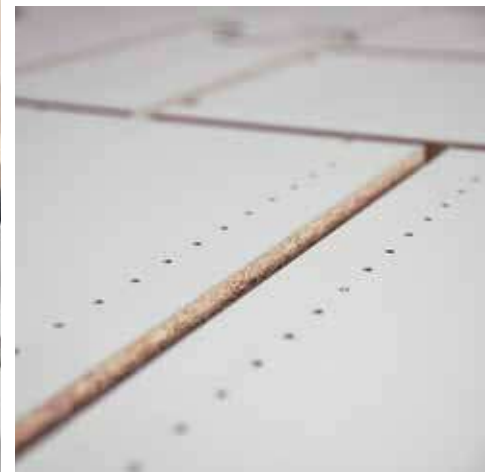
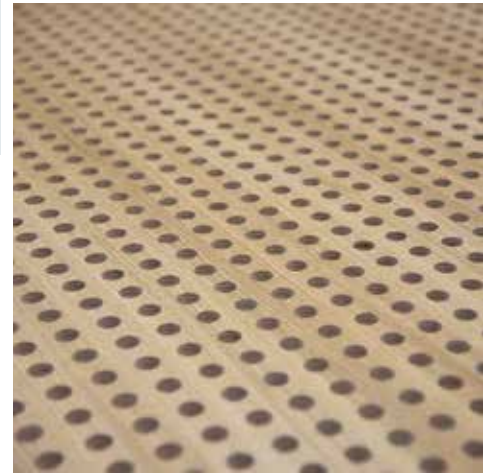

CARGO

PATENTED AUTOMATIC LOADING AND UNLOADING SYSTEM

PENDULUM MACHINING FOR HIGHEST PRODUCTIVITY OF DOORS AND PANELS

Fully automated solution that does not require operator supervision.



morbidelli m200

numerical controlled machining centre



Two stations; one for loading and one for unloading, easily accessible even with a forklift truck.



Maximum positioning accuracy on the work table thanks to the panel pre-alignment system directly on the loading stack.



Unrivalled ease of use; machine and Cargo system managed directly with Maestro active.



Cargo's flexible arm allows the continuous loading and unloading of workpieces in masked time, while the machine carries out the processing in the opposite area.

EVERYTHING YOU ALWAYS DREAMED OF A CNC MACHINING CENTRE BUT WERE TOO AFRAID TO ASK

SWEEP AWAY THE WORRIES

ALL CLEAN

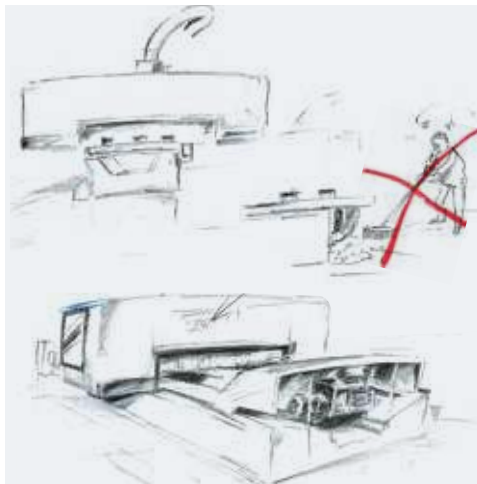

No problem with dust or shavings thanks to the intelligent solution of the dust collection box located in an ergonomic position.

Free space on the floor with the vacuum pump integrated in the machine base.

SPACE? NO PROBLEM!

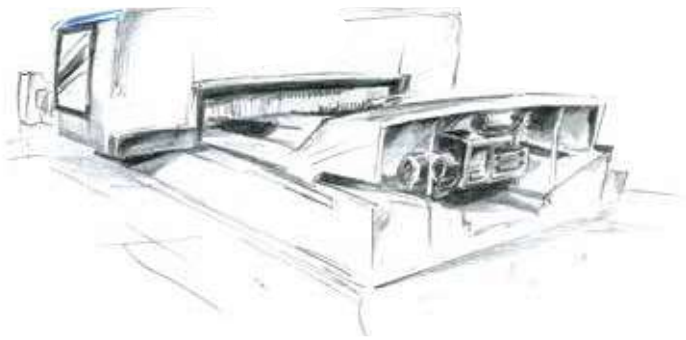

Free access without obstacles on the floor, cable-holder chain and vacuum pump integrated in the machine base.

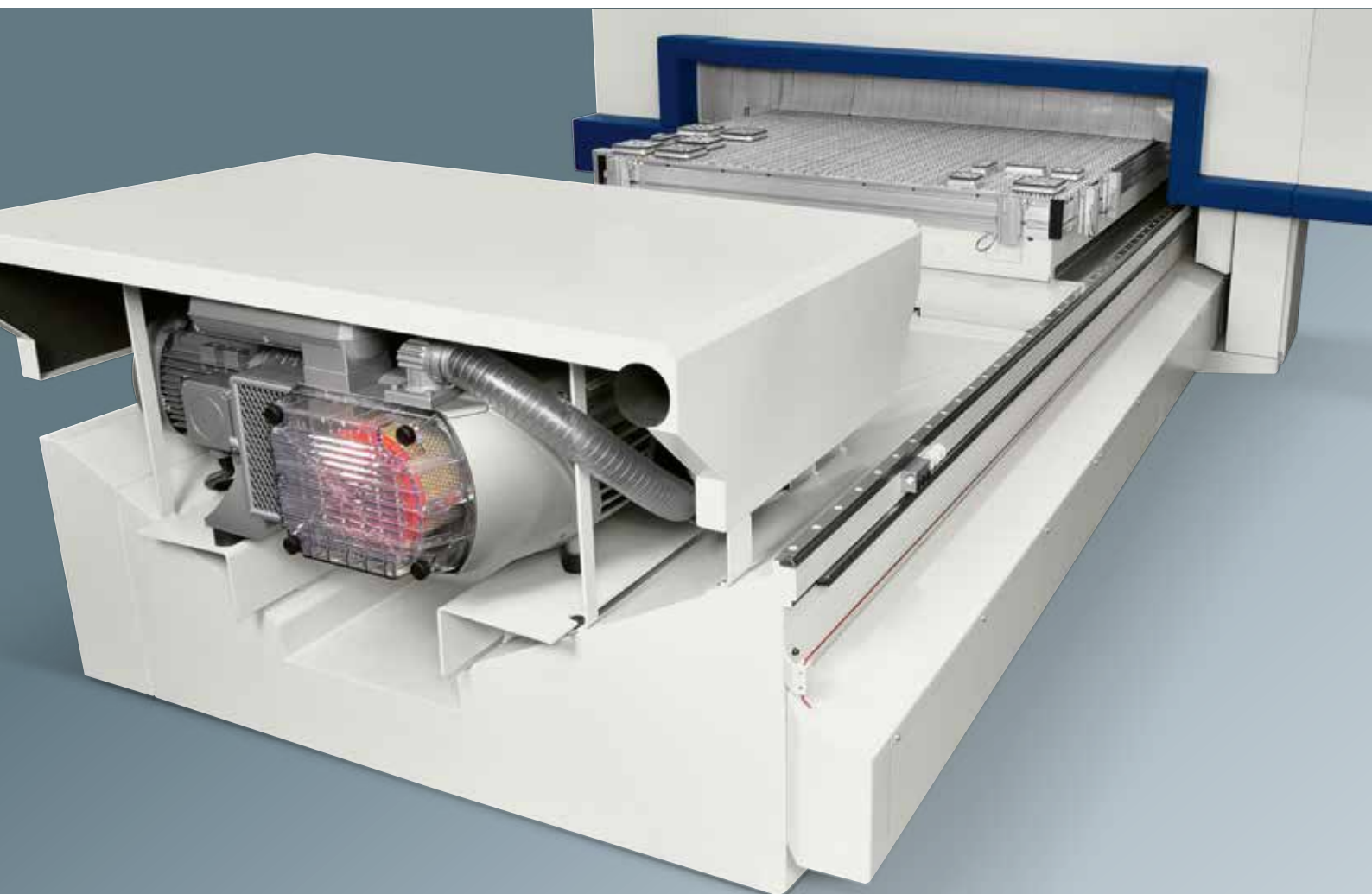

morbidelli m100/m200

numerical controlled machining centres



Rapidity and ergonomics to equip and do maintenance to the operating group thanks to the practical frontal opening.

No problem with dust or shavings thanks to the dust shavings conveyor belt equipped with exhaust outlet and the dust collection box located in an ergonomic position.



M Maestro Digital Systems

SMART SOFTWARE AND DIGITAL SERVICES TO ENHANCE PRODUCTIVITY OF WOODWORKING AND FURNITURE INDUSTRIES.

design > programming and data generation

Maestro office

Office

Factory

Maestro active

cutting > routing drilling

SOFTWARE

Simple, smart and open Maestro software are tailored on the machine technology as well as on the entire process. All Maestro software share a common mission:

easy to use, so that any operator can easily and confidently learn and use the software

smart, with algorithms and computing modules aiming at the best possible result

open in order to integrate existing software, and provide customer the coverage of all his process.



SCM accompanies woodworking companies throughout their whole process combining machines with matching software solutions and digital services, with a constant strive to enhance company productivity.

The software solutions powered by SCM are developed to optimize machine usage as well as the entire process, providing integration with the different software existing in the company.

DIGITAL SERVICES

Transforming the way it delivers services to its customers through digital technologies and particularly, the IoT platform that collects and analyses data coming from the machine, **SCM created a world of services enabled by Maestro connect.**

Meaning that connecting an SCM machine through Maestro connect will let customer subscribe a program of fast-evolving services and access a wide range of benefits that even go beyond the machine experience and will support and assist you through the whole life-cycle of your machine.

Maestro connect IoT Platform

1
Machine monitoring,
KPIs, early warning

2
Maintenance
equipment

3
Predictive
maintenance

4
Report and historical
data export to MES

5
Warranty
extension

6
Augmented
remote support

7
Smart learning,
SELF-HEALING,
video tutorials

8
Asset management
with e-shop SCM
Spare Parts



SOFTWARE

Maestro lab

From the office, the Maestro lab design and programming system ensures that all machining can quickly and easily be programmed.

Transforming an idea into a finished product has never been easier.

More than 150 already integrated apps allow to generate cnc programs with just a few mouse clicks.



Office

THE SOFTWARE THAT SIMPLIFIES THE WORK

CAD/CAM programming software to design all the production processes. Developed in Windows environment it ensures easy programming with an advanced, simple and intuitive sketching environment that features all the tools necessary to design the parts, tools management and the relative machining operations.

All the procedures are contained in a perfectly integrated and high performance software.

SUITE



Maestro pro view

3D Simulator that allows users access to a three dimensional model of their machine in their office and view the operations that will be carried out during the production in advance on their PC.



Maestro 3D

The module integrated in the Maestro suite is designed to program three dimensional objects on 5-axis machining centres.



Maestro apps

Maestro apps is a library of programming functions that are always available and easy to use, developed by SCM for the production of parts for doors, windows, stairs, furniture and furnishings.



Maestro msl connector

Connector for third-parties with design software.



Maestro nesting

The module integrated in the Maestro suite provides all the functions necessary to manage the "nesting" process: from a simple "rectangular" piece to the most varied and complex "free form" geometrical shapes.



Maestro label

Integrated module to manage label's models, which develops labels by inserting texts, images, parameters and the main barcode formats.



Maestro active cnc

Maestro active is the interface that the operator easily uses on all SCM machines: Maestro active interface software maintains the same look&feel, the same icons and the same approach to interaction.

EASE OF USE

The interface has been specifically designed and optimised for immediate use via touch screen, for a simple and comfortable navigation.

“ZERO” ERRORS

Improved productivity thanks to integrated help and recovery procedures that reduce the possibility of operator error.

Factory

A REVOLUTIONARY APPROACH TO INTERACT WITH YOUR SCM MACHINE

FULL CONTROL OF PRODUCTION PERFORMANCES

The creation of customisable reports by operator, shift, program, forecast period (and much more) allows to monitor, optimise and improve the performance.

FULL MACHINE AWARENESS AND KNOWLEDGE MANAGEMENT SYSTEM

Recording of maintenance, training and other events, tracing all the activities in a database. The operator's know-how is also stored and made available to other people inside the organisation thanks to the possibility to comment and document all production events or notifications.

ORGANIZE YOUR PRODUCTION

Creation of different users with different roles and authorisations (e.g.: operator, maintainer, administrator, ...). Possibility of defining the work shifts on the machine and then detect activities, productivity and events that occurred in each shift.

TOTAL QUALITY OF THE FINISHED PRODUCT

The quality of finished piece is no longer put at risk by worn tools. The new Maestro active Tool Life Determination system sends notification messages as the tool reaches its end of life and recommends its replacement at the most appropriate time.

TOOLS? NO PROBLEM!

Maestro active guides the operator during the tool change phase, taking into account the programs to be executed.

A WORLD OF SERVICES FOR GREATER EFFICIENCY

Maestro connect

CONNECT YOUR MACHINE AND GAIN ACCESS TO A WORLD OF SERVICES

Connecting your machine through Maestro connect will let you subscribe a program of fastevolving services. You will access a wide range of benefits that even go beyond the machine experience and will support and assist you through the whole life-cycle of your machine.

FASTER SERVICE INTERVENTION AND PROBLEM RESOLUTION

Maestro connect provides real time data and Health Records of the Machine also to SCM Service drastically reducing its troubleshooting time.

WORKING ALWAYS IN PERFECT CONDITIONS

Maestro Connect can provide a full kit of sophisticated sensor devices to detect and warn the operator in case of alarming conditions of the machine.

DIGITAL SERVICES

SMART MAINTENANCE: DOWN TIME REDUCTION

Maestro connect reduces maintenance downtime thanks to:

- Automatic maintenance notifications and scheduling, to prevent failures and work in the best conditions of use
- Direct connection to SCM Service thanks to an automatic ticket opening function

SMART MACHINE: ANYTIME, ANYWHERE AWARENESS

Connecting your SCM machine also means having your machine always at hand. Immediate instant notifications in case of alarms or downtimes allow customers to immediately take an action thus optimizing his productivity.

SMART MANAGEMENT: PRODUCTION PERFORMANCE OPTIMIZATION

Reports and KPIs allow further analysis thus increasing Customer Knowledge about his performance and results.

SMART PARTS: FAST PARTS REPLENISHMENT

Repairs are scheduled proactively since the system provides Spare Parts suggestions and a direct Integration with Smart Parts e-shop.

SMART LEARNING: EXECUTE WORK AND RECEIVE PROBLEM SOLVING SUPPORT

Maestro connect provides an intuitive Problem Solving Management System to help the operator to self solve any issue..

SMARTECH: FASTER AUGMENTED SUPPORT

Maestro connect allows augmented reality support by means of Smartech: the head-wearable computers with wireless connectivity that will bring the interaction between customer and SCM service to a higher level.

SMART WARRANTY: YOUR MACHINE ALWAYS IN PERFECT CONDITIONS

Together with scheduled maintenance contracts, you can take care of your asset by doubling the warranty from 1 year to 2 years* for complete peace of mind!

** please read the complete contract to understand terms and conditions.*

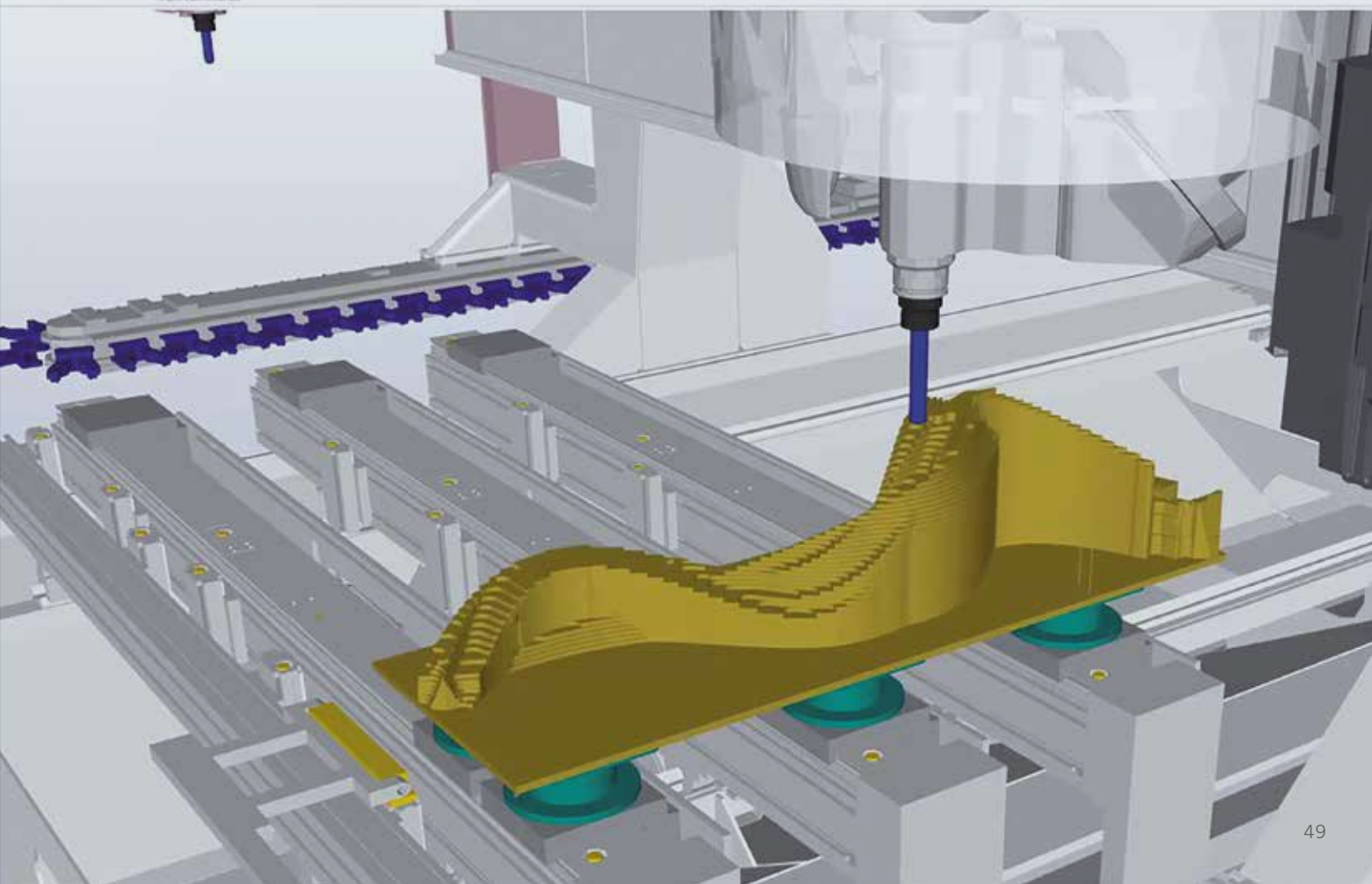
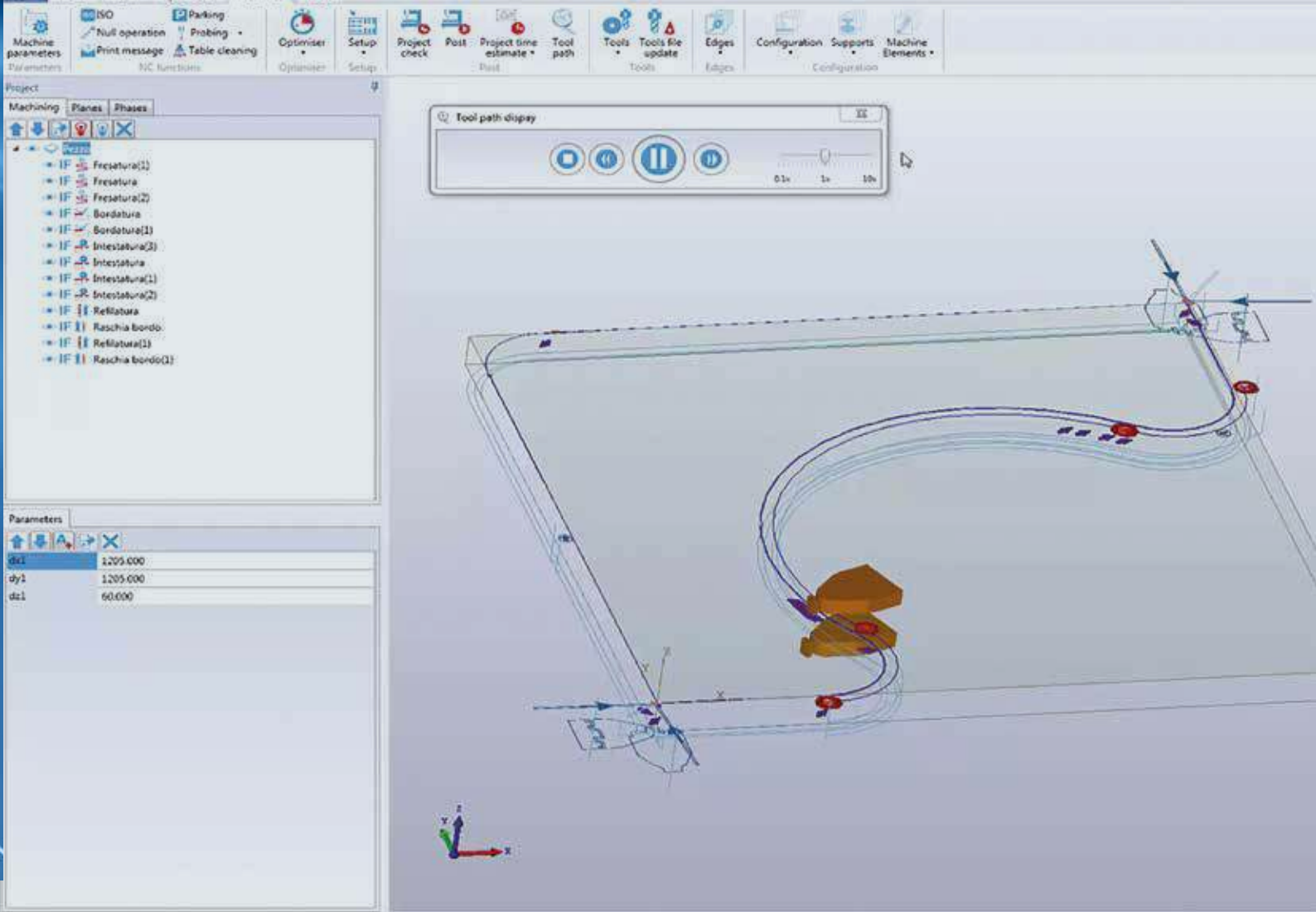

ALL READY



1 technician, 1 day and the machine is up and running!

TECHNICAL DATA

MORDIBELLI		M100	M200
AXES			
Vectorial speed X-Y axes "PRO-SPACE" version *	m/min	56	56
Vectorial speed X-Y axes "PRO-SPEED" version **	m/min	78	78
Z axis panel passage	mm	180 (250 opt.)	250
ROUTING UNIT			
Motor power (max.)	kW (hp)	15 (20,5)	15 (20,5)
Rotation speed (max.)	rpm	24000	24000
Available tools on tool changer (up to)	places	57	77
DRILLING UNIT			
Independent vertical spindles (up to)	n.	21	21
Independent horizontal spindles (up to)	n.	12	12
Rotation speed (max.)	rpm	8000	8000
Integrated blade in X, diameter	mm	125	125
INSTALLATION			
Exhaust air consumption	m ³ /h	4430	4430
Exhaust air speed	m/sec	25	25
Exhaust outlet diameter	mm	250	250

* with high dynamic equipment: 84 m/mm

**with high dynamic equipment: 113 m/mm



THE USE OF POWER ONLY WHEN IT IS REQUIRED

SavEnergy allows making things operate only when they are really necessary. It means the machine automatically enters "stand-by" mode when there are no panels to be machined.

**COMPANY WITH
QUALITY SYSTEM
CERTIFIED BY DNV
ISO 9001**

The technical data can vary according to the requested machine composition. In this catalogue, machines are shown with options. The company reserves the right to modify technical specifications without prior notice; the modifications do not influence the safety foreseen by the CE Norms.

*Maximum noise levels measured according to the operating conditions established by EN 848-3:2012
Acoustic pressure in process (routing) 81 dbA (measured according to EN ISO 11202:2010, uncertainty K = 4 dB)
Acoustic power in process (routing) 98 dbA measured according to EN ISO 3746:2010, uncertainty K = 4 dB)*





Even if there is a correlation between above mentioned "conventional" noise emission values and average levels of personal exposure over eight hours of operators, these last also depend on the real operating conditions, duration of exposure, acoustic conditions of the working environment and presence of further noise sources, this means the number of machines and other adjacent processes.

WE'LL GO THE EXTRA MILE FOR YOU



SCM OFFERS A FULL RANGE OF **HIGHLY SPECIALISED SERVICES** WITH A QUALITY AND RELIABILITY THAT STEM FROM 70 YEARS OF EXPERIENCE IN THE INDUSTRY.

From installation and production start-up to services and maintenance. From training to the supply of specific original spare parts: **we provide solutions designed around you!**

 <p>SERVICE AND MAINTENANCE</p> <ul style="list-style-type: none"> • Remote support • Scheduled maintenance contracts • Warranty extension 	 <p>TRAINING SERVICE</p> <ul style="list-style-type: none"> • Courses for machine operators • Software and programming courses • Training in production start-up
 <p>SPARE PARTS</p> <ul style="list-style-type: none"> • Recommended spare parts list • E-shop • Interactive spare-parts catalogues • Repairs on electronic parts, glue tanks and electro-spindles 	 <p>DIGITAL SERVICES</p> <ul style="list-style-type: none"> • Maestro Connect - IoT platform to be constantly connected with your machines • Smartech - assistance with augmented reality • My Scm portal - opening of service ticket and single point of access to the apps and Services tools

CONTACT

SCM SERVICE

via Emilia 77 - 47921 Rimini - Italy
 tel. +39 0541 700100
 scmsservice@scmgroup.com
 www.scmwood.com

SCM SPAREPARTS

Via Casale, 450 - 47826 - Villa Verucchio (RN) - Italy
 tel. +39 0541 674111
 spareparts@scmgroup.com
 www.scmwood.com



THE STRONGEST WOOD TECHNOLOGIES ARE IN OUR DNA

SCM. A HERITAGE OF SKILLS IN A UNIQUE BRAND

70 years of success gives SCM the centre stage in woodworking technology. This heritage results from bringing together the best know-how in machining and systems for wood-based manufacturing. SCM is present all over the world, brought to you by the widest distribution network in the industry.

70 years history

3 main production sites in Italy

300.000 square metres of production space

20.000 machines manufactured per year

90% export

20 foreign branches

400 agents and dealers

500 support technicians

500 registered patents



In SCM's DNA also strength and solidity of a great Group. The SCM Group is a world leader, manufacturing industrial equipment and components for machining the widest range of materials.

SCM GROUP, A HIGHLY SKILLED TEAM EXPERT IN INDUSTRIAL MACHINES AND COMPONENTS

INDUSTRIAL MACHINERY

Stand-alone machines, integrated systems and services dedicated to processing a wide range of materials.



WOODWORKING TECHNOLOGIES



TECHNOLOGIES FOR PROCESSING
COMPOSITE MATERIALS, ALUMINIUM,
PLASTIC, GLASS, STONE, METAL

INDUSTRIAL COMPONENTS

Technological components for the Group's machines and systems, for those of third-parties and the machinery industry.



SPINDLES AND
TECHNOLOGICAL
COMPONENTS



ELECTRIC PANELS



METALWORK



CAST IRON



SCM GROUP SPA

via Casale 450 - 47826 Villa Verucchio, Rimini - Italy
tel. +39 0541 674111 - fax +39 0541 674274
morbidelli@scmgroup.com
www.scmwood.com



00L0367193C