

Vertical Sliding System / Giyotin Sistem

VEGA

VEGA Technical Properties / Teknik Özellikler

Vertical Sliding System / Giyotin Sistem

VEGA

Profile Technical Properties / Profil Teknik Özellikleri

Bottom Profile / Alt Kasa Profil 127 x 20 mm

Wall Thickness of Bottom Profile / Alt Kasa Profili Et Kalınlığı 1,5 mm

Top Profile / Üst Kasa Profili 127 x 123 mm

Wall Thickness of Top Profile / Üst Kasa Et Kalınlığı 2,3 mm

Bottom Panel Profile / Alt Baza Profili 29 x 34 mm

Wall Thickness of Bottom Panel Profile / Alt Baza Profili Et Kalınlığı 2 mm

Side Panel Profile / Yan Baza Profili 29 x 33 mm

Wall Thickness of Side Panel Profile / Yan Baza Profili Et Kalınlığı 3 mm

Silinebilir Sistem / Cleanable System

Technical Properties Roof / Çatı Teknik Özellikleri

System Height / Sistem Yüksekliği 3000 mm

Panel Width / Panel Geniřlięi 4000 mm

Glass Thickness / Cam Kalınlığı 22 mm Double Glass / Isıcam

Glass Type / Cam Tipi Tempered / Laminated

Profile Colors (In Stock) / Profil Renkleri (Stokta) Press / Ham

Panel Cap Colours (In Stock) / Panel Kapak Renkleri (Stokta) Grey, Black / Gri, Siyah

VEGA Profiles / Profiller

Scale / Ölçek: 1/2

Vertical Sliding System / Giyotin Sistem

VEGA

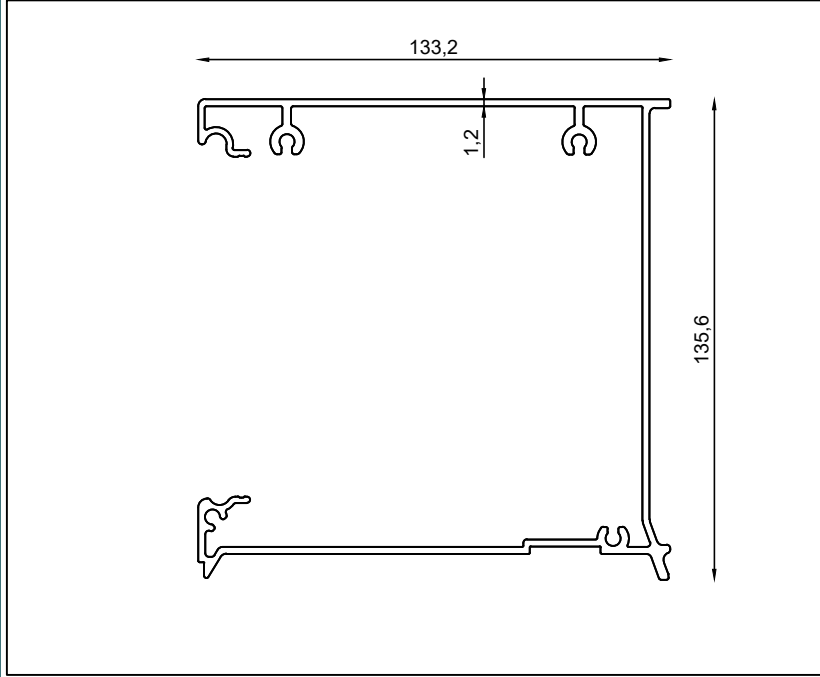

Profile Name: / Profil İsim:

Top Profile / Üst Profili

Code Nr.: / Kod No.:

KPSG-UP-01

Weight kg/m: / Ağırlık

22,82 kg - 7,00 m - (3,26 kg/m)

19,56 kg - 6,00 m - (3,26 kg/m)

16,30 kg - 5,00 m - (3,26 kg/m)

13,04 kg - 4,00 m - (3,26 kg/m)

9,78 kg - 3,00 m - (3,26 kg/m)

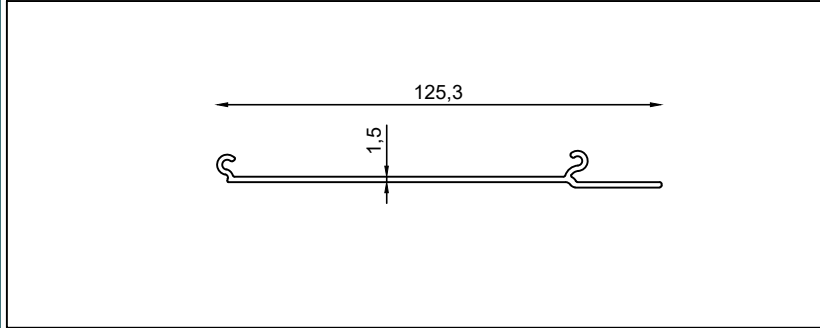

Profile Name: / Profil İsim:

Cover Profile / Kapak Profili

Code Nr.: / Kod No.:

KPG-KAP3-2

Weight kg/m: / Ağırlık:

2,40 kg - 4,00 m - (0,60 kg/m)

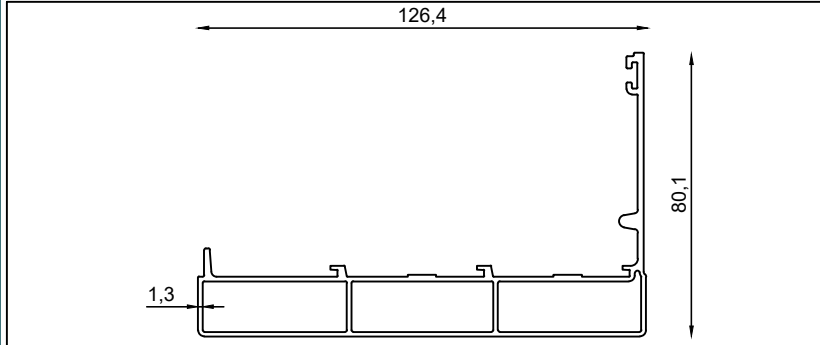

Profile Name: / Profil İsim:

Side Body Strut Frame Profile / Yan Gövde Dikme Kasa Profili

Code Nr.: / Kod No.:

KPSG-YGDK-01

Weight kg/m: / Ağırlık:

9,67 kg - 6,00 m - (1,61 kg/m)

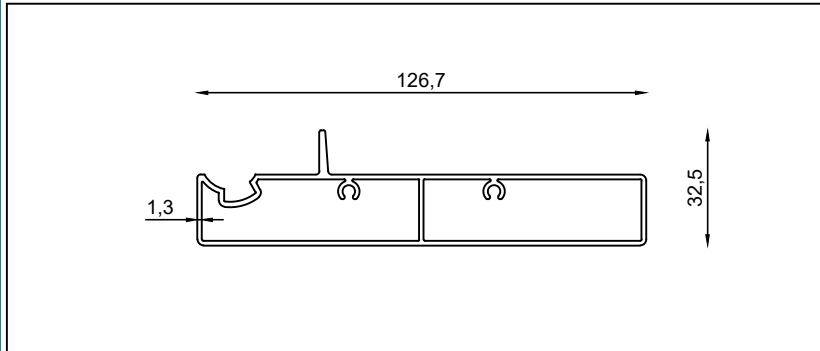

Profile Name: / Profil İsim:

Bottom Hinge Profile / Menteşe Alt Kasa Profil

Code Nr.: / Kod No.:

KPSG-MAK-01

Weight kg/m: / Ağırlık:

5,16 kg - 4,00 m - (1,29 kg/m)

VEGA Profiles / Profiller

Scale / Ölçek: 1/2

Vertical Sliding System / Giyotin Sistem

VEGA

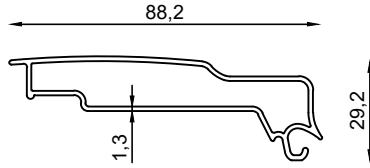

Profile Name: / Profil İsim:

Movable Handrail Cover / Hareketli Küpeşte Kapak

Code Nr.: / Kod No.:

KPSG-HKP-01

Weight kg/m: / Ağırlık:

4,56 kg - 6,00 m - (0,76 kg/m)

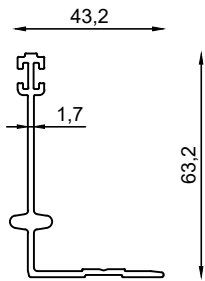

Profile Name: / Profil İsim:

Side Bearings Profile / Yan Yataklar Profili

Code Nr.: / Kod No.:

KPSG-YYP-01

Weight kg/m: / Ağırlık:

3,84 kg - 6,00 m - (0,64 kg/m)

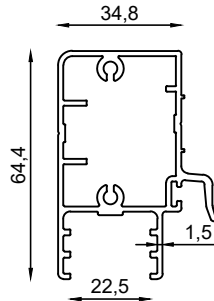

Profile Name: / Profil İsim:

Fixed Opening Panel Plinth Profile / Sabit Açılır Panel Baza Profili

Code Nr.: / Kod No.:

KPSG-SAPB-01

Weight kg/m: / Ağırlık:

3,60 kg - 3,00 m - (1,20 kg/m)

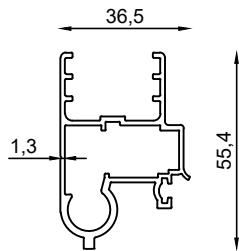

Profile Name: / Profil İsim:

Bottom Hinge Plinth Profile / Alt Menteşe Baza Profili

Code Nr.: / Kod No.:

KPSG-AMB-01

Weight kg/m: / Ağırlık:

4,80 kg - 6,00 m - (0,80 kg/m)

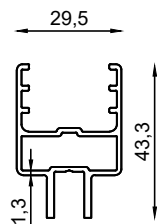

Profile Name: / Profil İsim:

Side Panel Plinth Chain Connection Profile / Panel Yan Baza Zincir Bağlantı Profili

Code Nr.: / Kod No.:

KPSG-PBZBP-01

Weight kg/m: / Ağırlık:

3,60 kg - 6,00 m - (0,60 kg/m)

VEGA Profiles / Profiller

Scale / Ölçek: 1/2

Vertical Sliding System / Giyotin Sistem

VEGA

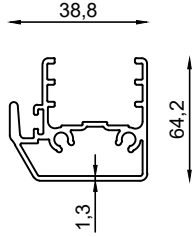

Profile Name: / Profil İsim:

New Pull Base Profile / Yeni Çekme Baza Profili

Code Nr.: / Kod No.:

KPSG-YCB-01

Weight kg/m: / Ağırlık:

4,32 kg - 6,00 m - (0,72 kg/m)

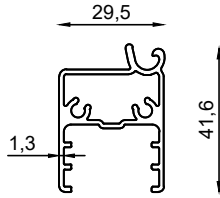

Profile Name: / Profil İsim:

Top Panel Handrail Plinth Profile / Üst Panel Kûpeşte Baza Profili

Code Nr.: / Kod No.:

KPSG-UPKB-01

Weight kg/m: / Ağırlık:

4,02 kg - 6,00 m - (0,67 kg/m)

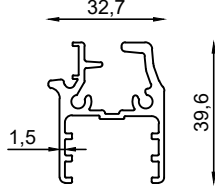

Profile Name: / Profil İsim:

New Small Pull Profile / Yeni Küçük Çekme Baza Profili

Code Nr.: / Kod No.:

KPG-YKCB-01

Weight kg/m: / Ağırlık:

5,34 kg - 6,00 m - (0,89 kg/m)

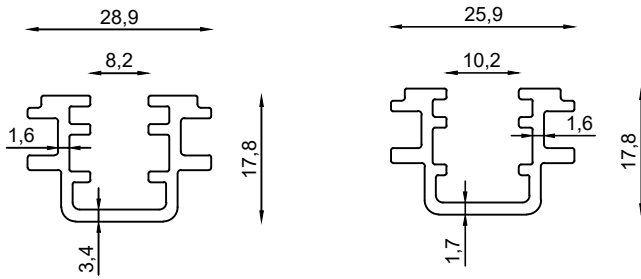

Profile Name: / Profil İsim:

8 -10 mm Plinth Profile / 8 -10 mm Baza Profil

Code Nr.: / Kod No.:

KPG-CB8-12 KPG-CB10-12

Weight kg/m: / Ağırlık:

2,22 kg - 6,00 m - (0,37 kg/m)

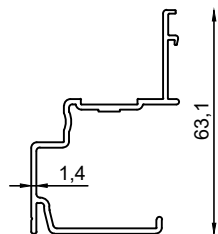

Profile Name: / Profil İsim:

Side Panel Chain Cover Profile / Yan Kasa Zincir Kapak Profili

Code Nr.: / Kod No.:

KPSG-YZKP-01

Weight kg/m: / Ağırlık:

4,32 kg - 6,00 m - (0,72 kg/m)

VEGA Profiles / Profiller

Scale / Ölçek: 1/2

Vertical Sliding System / Giyotin Sistem

VEGA

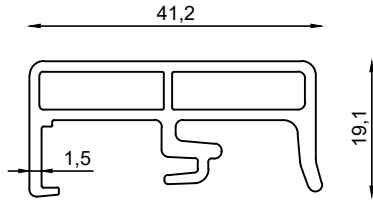

Profile Name: / Profil İsim:

Middle Panel Pull Profile / Orta Panel Çekme Kızak

Code Nr.: / Kod No.:

KPSG-OPCK-01

Weight kg/m: / Ağırlık:

4,32 kg - 6,00 m - (0,72 kg/m)

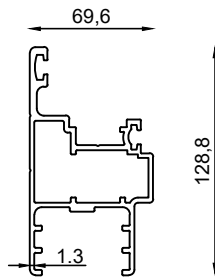

Profile Name: / Profil İsim:

Fixed Opening Panel Side Plinth / Sabit Açılır Panel Yan Baza

Code Nr.: / Kod No.:

KPSG-SAPYB-01

Weight kg/m: / Ağırlık:

5,10 kg - 6,00 m - (0,85 kg/m)

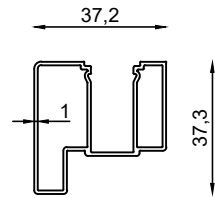

Profile Name: / Profil İsim:

Photocell Profile / Fotosel Profili

Code Nr.: / Kod No.:

KPSG-FY-01

Weight kg/m: / Ağırlık:

3,00 kg - 6,00 m - (0,50 kg/m)

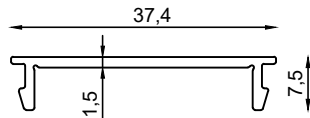

Profile Name: / Profil İsim:

Side Case Skid Cover Profile / Yan Kasa Kızak Kapağı Profili

Code Nr.: / Kod No.:

KPG-YK2-11

Weight kg/m: / Ağırlık:

1,20 kg - 6,00 m - (0,2 kg/m)

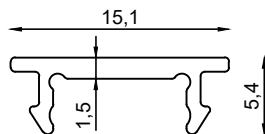

Profile Name: / Profil İsim:

Photocell Cover Profile / Fotosel Yatağı Kapak Profili

Code Nr.: / Kod No.:

KPSG-FYK-02

Weight kg/m: / Ağırlık:

4,92 kg - 6,00 m - (0,82 kg/m)

VEGA Accessory / Aksesuar

Scale / Ölçek: 1/2

Vertical Sliding System / Giyotin Sistem

VEGA

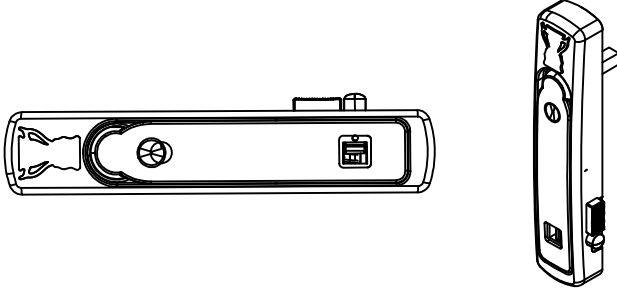

Profile Name: / Profil İsim:

Espagnolette Lock Handle / İspanyolet Kilit Çevirme Kolu

Code Nr.: / Kod No.:

KPSG-HISPK-13

Material / Malzeme:

Polyamid / Zamak

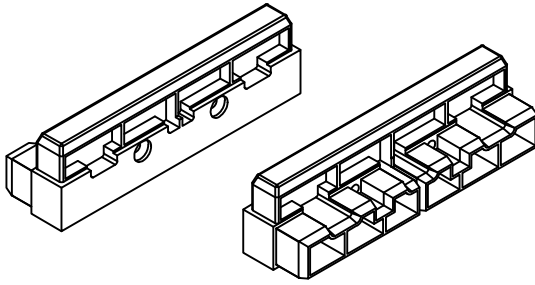

Profile Name: / Profil İsim:

Bottom Bracket Connection Piece / Alt Bağlantı Aparatı

Code Nr.: / Kod No.:

KPG-ABA-2

Material / Malzeme:

Polyamide / Polyamid

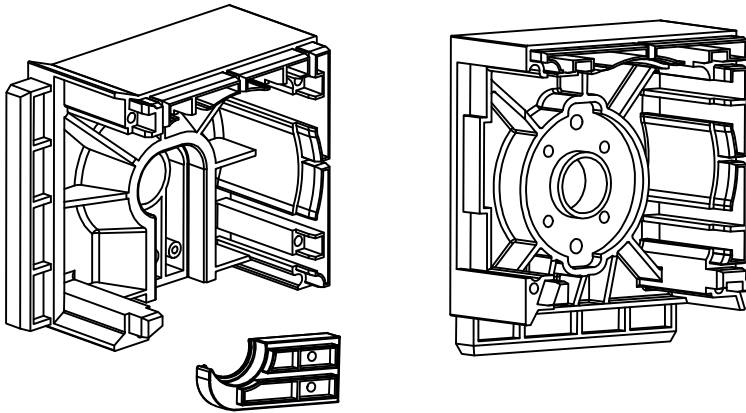

Profile Name: / Profil İsim:

Motor Block Cap Set / Motor Blok Seti

Code Nr.: / Kod No.:

KPG-MBS-3

Material / Malzeme:

Polyamide / Polyamid

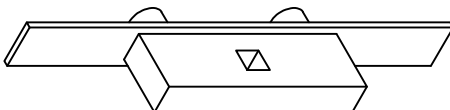

Profile Name: / Profil İsim:

Single Espagnolette 28 cm / Tek Açılır İspanyolet 28 cm

Code Nr.: / Kod No.:

KPO-KKT-21

Material / Malzeme:

Metal / Metal

VEGA Accessory / Aksesuar

Scale / Ölçek: 1/2

Vertical Sliding System / Giyotin Sistem

VEGA

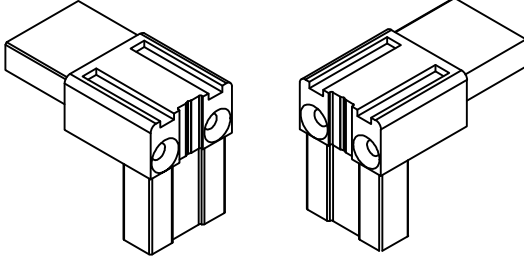

Profile Name: / Profil İsim:

Panel Plinth Cover / Panel Baza Kapağı

Code Nr.: / Kod No.:

KPSG-PBK-01

Material / Malzeme:

PVC / PVC

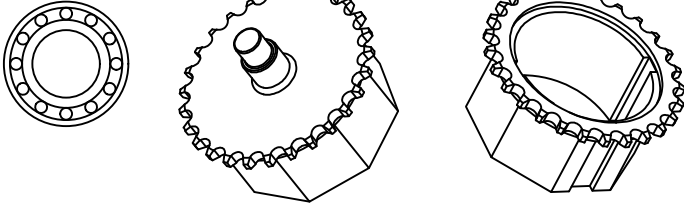

Profile Name: / Profil İsim:

Chain Gear Set / Zincir Dişli Seti

Code Nr.: / Kod No.:

KPG-ZDDS-6

Material / Malzeme:

Steel / Çelik



Profile Name: / Profil İsim:

Chain 3,8 / Zincir 3,8

Code Nr.: / Kod No.:

KPG-Z-7

Material / Malzeme:

Steel / Çelik

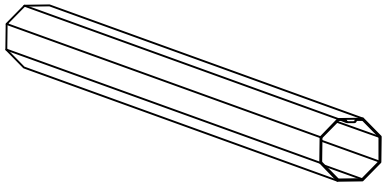

Profile Name: / Profil İsim:

Motor Barrel / Motor Tamburu

Code Nr.: / Kod No.:

KPG-MT-8

Material / Malzeme:

Steel / Çelik

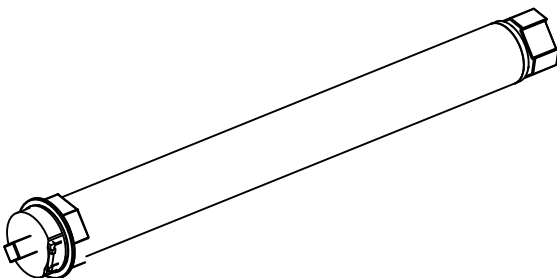

Profile Name: / Profil İsim:

Tubular Motor Set / Tüp Motor Seti

Code Nr.: / Kod No.:

KPG-TMS-9

Company / Firma

BECKER 120 N/m inc. Remote Control

VEGA Accessory / Aksesuar

Scale / Ölçek: 1/2

Vertical Sliding System / Giyotin Sistem

VEGA

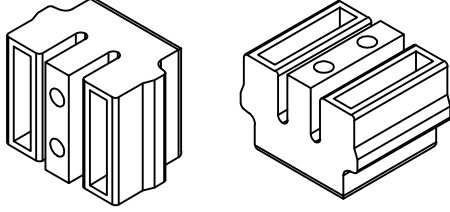

Profile Name: / Profil İsim:

Panel Slide Pieces / Panel Kızak Yatakları

Code Nr.: / Kod No.:

KPSG-PKY-01

Material / Malzeme:

PVC / PVC

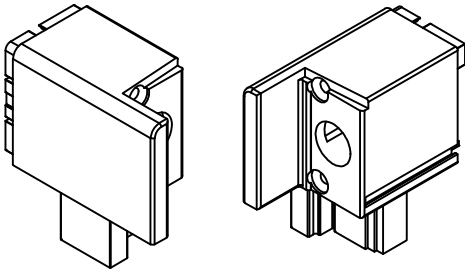

Profile Name: / Profil İsim:

Bottom Panel Cover / Alt Panel Kapak

Code Nr.: / Kod No.:

KPSG-APK-01

Material / Malzeme:

PVC / PVC

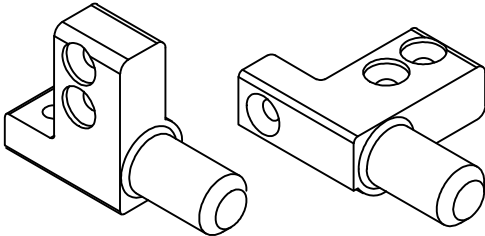

Profile Name: / Profil İsim:

Bottom Panel Hinge / Alt Panel Mentеше

Code Nr.: / Kod No.:

KPSG-APM-01

Material / Malzeme:

PVC / PVC

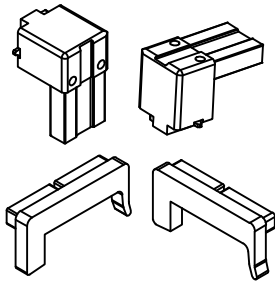

Profile Name: / Profil İsim:

Middle Panel Cover / Orta Panel Kapak

Code Nr.: / Kod No.:

KPSG-OPK-01

Material / Malzeme:

PVC / PVC

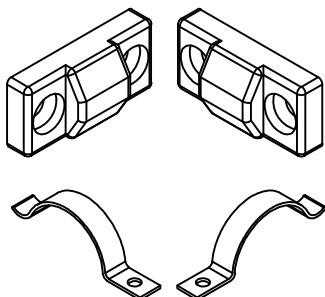

Profile Name: / Profil İsim:

Middle Panel Push Set / Orta Pabuç İtekleme Aparatı ve Yaprak Yayı

Code Nr.: / Kod No.:

KPSG-OPI-01

Material / Malzeme:

PVC - Steel / PVC - Çelik

VEGA Accessory / Aksesuar

Scale / Ölçek: 1/2

Vertical Sliding System / Giyotin Sistem

VEGA

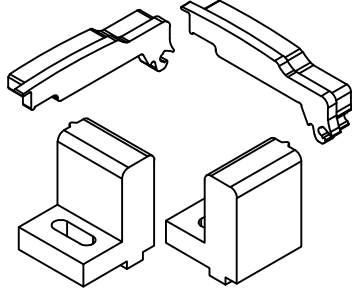

Profile Name: / Profil İsim:

Handrail Cover and Dust Cover / K peşte Kapak ve TozluK

Code Nr.: / Kod No.:

KPSG-KKT-01

Material / Malzeme:

PVC / PVC

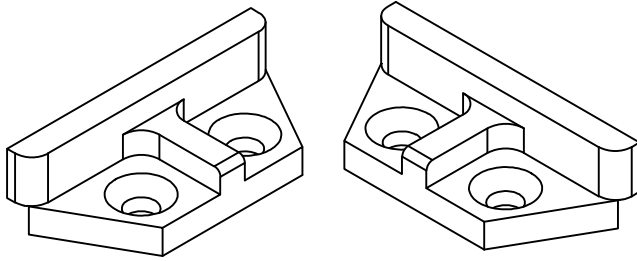

Profile Name: / Profil İsim:

Espagnolette Key Lock / İspanyolet Kilit Karşılığı

Code Nr.: / Kod No.:

KPO-ISP K-08

Material / Malzeme:

Zamac / Zamak

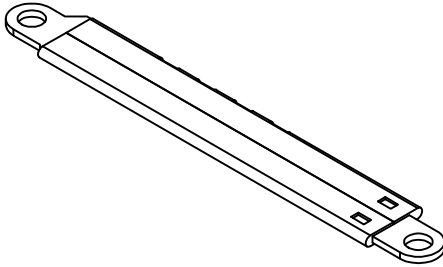

Profile Name: / Profil İsim:

Varista Arm / Vatistas Kol

Code Nr.: / Kod No.:

KPSG-VT-01

Material / Malzeme:

Steel /  elik

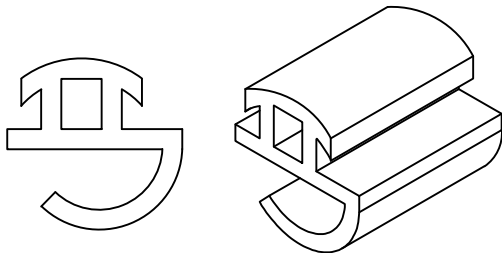

Profile Name: / Profil İsim:

Espagnolette Lock Gasket / İspanyolet Kilit Contası

Code Nr.: / Kod No.:

KPSG-ISP C-01

Material / Malzeme:

Rubber / Kau uk

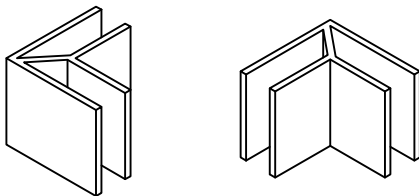

Profile Name: / Profil İsim:

Angular Connection Piece / A ı Birleřtirme Aparatı

Code Nr.: / Kod No.:

KPSG-CG-05

Material / Malzeme:

Al minium / Al minyum

VEGA Accessory / Aksesuar

Scale / Ölçek: 1/2

Vertical Sliding System / Giyotin Sistem

VEGA

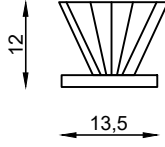

Name: / İsim:

Side Panel Profile Insulation Brush (Filmed) / Yan Kasa Kıl Fıtıl (Filmi)

Code Nr.: / Kod No.:

KP-KFIT600-1001

Material / Malzeme:

PVC / PVC

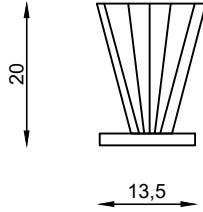

Name: / İsim:

Side Panel Profile Insulation Brush (Filmed) / Yan Kasa Kıl Fıtıl (Filmi)

Code Nr.: / Kod No.:

KPO-KFIT1000-1002

Material / Malzeme:

PVC / PVC

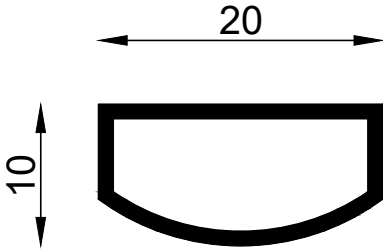

Name: / İsim:

Top Profile Gasket / Üst Profil Contası

Code Nr.: / Kod No.:

KPG-UPC-11

Material / Malzeme:

Rubber / Kauçuk

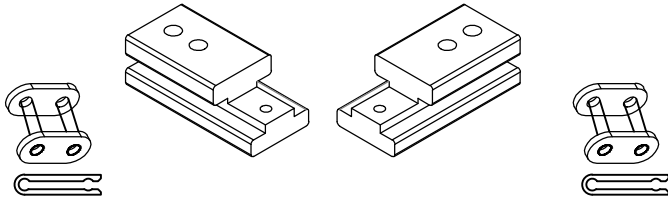

Name: / İsim:

Chain Connect Set / Zincir Bağlantı Seti

Code Nr.: / Kod No.:

KPG-ZBA-5 /KPG-ZAK-05

Material / Malzeme:

Metal / Metal

Name: / İsim:

Code Nr.: / Kod No.:

Material / Malzeme:

VEGA Section / Kesit

Scale / Ölçek: 1/2

Vertical Sliding System / Giyotin Sistem

VEGA

Inside / İç

Outside / Dış

4+14+4 mm Temp. Glass /
4+14+4 mm Temp. Cam

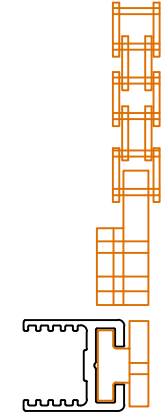

Section / Kesit

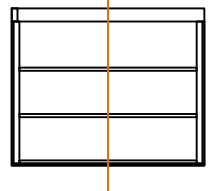

01	KPSG-UP-01	04	KPSG-AMB-01	07	KPG-YKCB-01	10	KPSG-HKP-01
02	KPG-KAP3-2	05	KPSG-SAPB-01	08	KPSG-OPCK-01		
03	KPSG-MAK-01	06	KPSG-YCB-01	09	KPSG-UPKB-01		

VEGA Section / Kesit

Scale / Ölçek: 1/2

Vertical Sliding System / Giyotin Sistem

VEGA

Inside / İç

4+14+4 mm Temp. Glass /
4+14+4 mm Temp. Cam

Outside / Dış

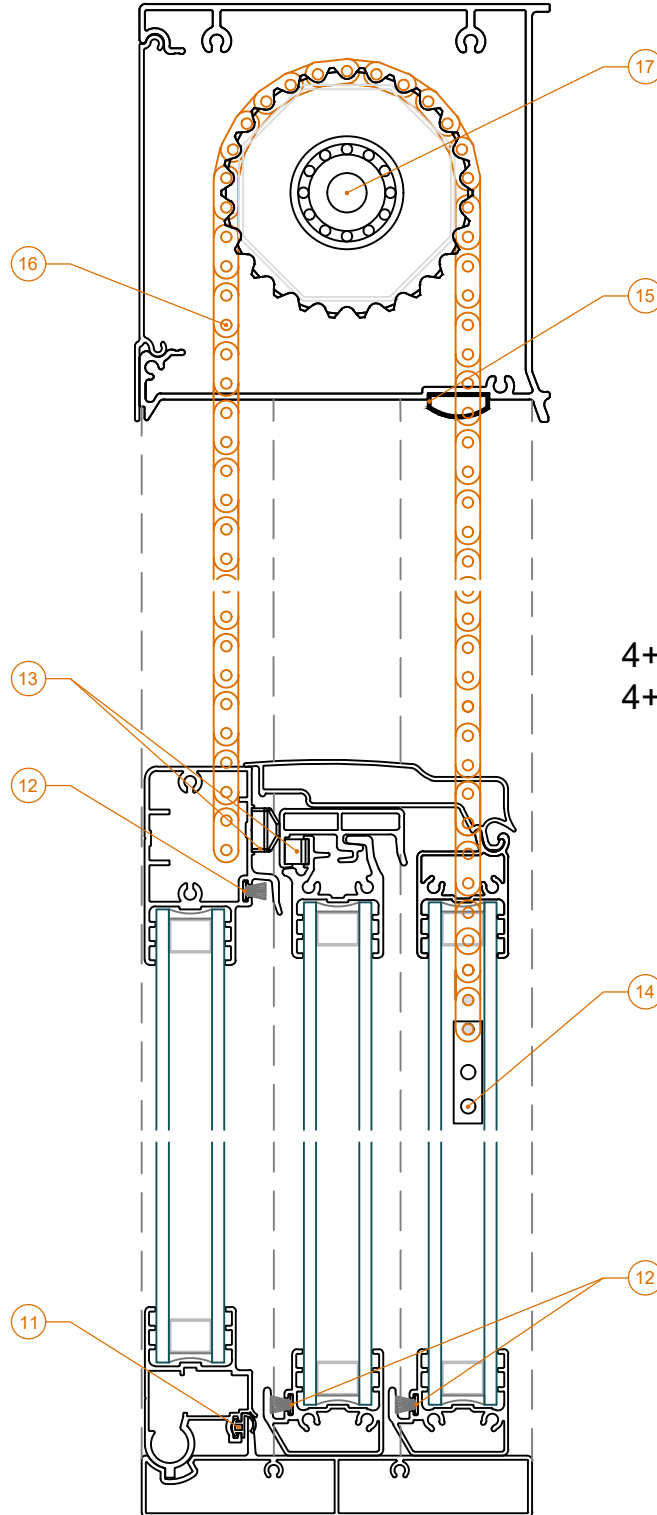

Section / Kesit

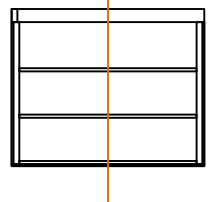

11	KPSG-ISP KC-01	14	KPG-ZBA-5 /KPG-ZAK-05	17	KPG-ZDDS-6
12	KP-KFIT600-1001	15	KPG-UPC-11		
13	KPSG-OPI-01	16	KPG-Z-7		

VEGA Top Section / Üst Kesit

Scale / Ölçek: 1/2

Vertical Sliding System / Giyotin Sistem

VEGA

Inside / İç

4+14+4 mm Temp. Glass /
4+14+4 mm Temp. Cam

Outside / Dış

Section / Kesit

18	KPSG-YGDK-01	21	KPSG-PBZBP-01	24	KPO-KFIT1000-1002
19	KPSG-YYP-01	22	KPSG-SAPYB-01	25	KPG-YK2-11
20	KPSG-YZKP-01	23	KPSG-ISPKC-01		

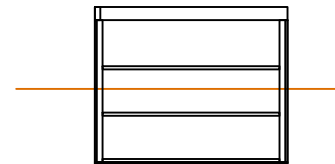

VEGA Front View / Ön Görünüş

Scale / Ölçek: 1/2

Vertical Sliding System / Giyotin Sistem

VEGA

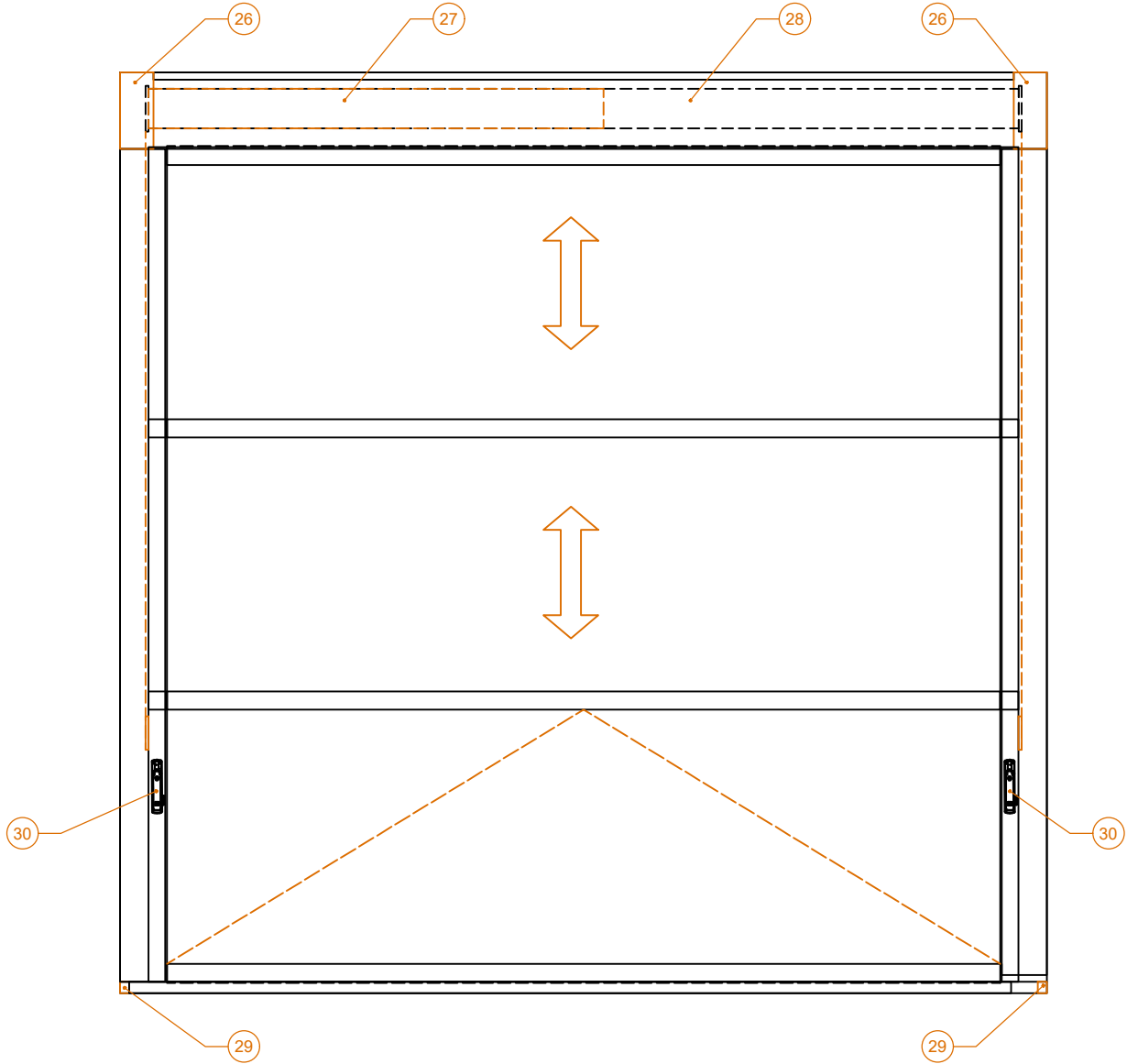

26	KPG-MBS-3	29	KPG-ABA-2
27	KPG-TMS-9	30	KPSG-HISPK-13
28	KPG-MT-8		