

531

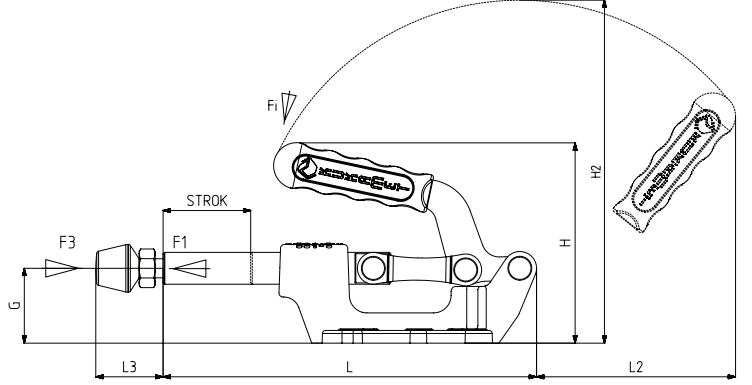

MODEL NO	F1 (N)	F3 (N)	Fi	BASKI VİDASI (SQUEEZE SCREW)	STROK	AĞIRLIK (WEIGHT) (gr ±%)
			VERİM (YIELD) (F1:Fi)			
531 - 3 (Ø 12)	2500	3700	16:1	M8X50	38	635
531 - 3 (Ø 14)	2500	4000	16:1	M8X50	38	645
531 - 4 (Ø 16)	4500	8100	23:1	M10X70	47	1140
531 - 4 (Ø 18)	4500	8800	23:1	M10X70	47	1150
531 - 5 (Ø 20)	7500	18450	30:1	M12X80	55	1835

F1 : BASKI KUVVETİ (EXERTING FORCE) , F3 : TUTMA KAPASİTESİ (HOLDING CAPACITY)
Fi : UYGULAMA KUVVETİ (APPLIED FORCE)



Ayak Tipi: Yatay Tabanlı, Döküm Gövdeli Body Mounting Base: Horizontal, Casting

Ürün özellikleri ;

Ağır iş uygulamalarında kullanıma uygun mukavemetli ürünlerdir.
Gövde mukavemetli GGG-60 döküm malzemeden üretilmiş ve siyah elektro statik toz boya ile boyanmıştır.

Mil, yüksek aşınma direnci ve korozyon direnci için sert krom kaplı malzemeden üretilmiştir.
Mekanizma parçaları çelik malzemeden üretilmiş ve korozyon direnci için galvaniz kaplama yapılmıştır.

Product Features ;

The products are strong and suited for heavy duty applications.

The body is made of strong GGG-60 casting and coated with black electrostatic powder paint.

The rod is made of hard chrome plated steel for high wear and corrosion resistance and the mechanism parts are made of galvanized steel for corrosion resistance.



531

Sayfa/Page: 64



532

Sayfa/Page: 68



533

Sayfa/Page: 69

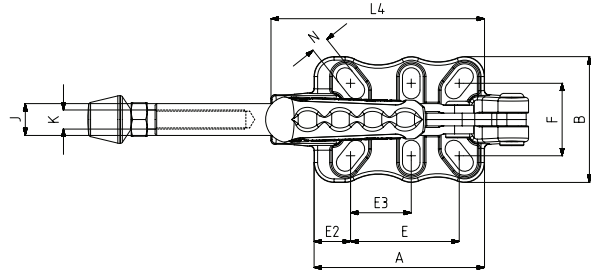

MODEL NO : 531-5

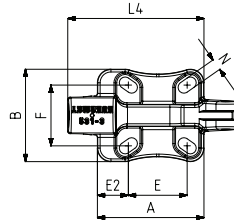

MODEL NO : 531-3

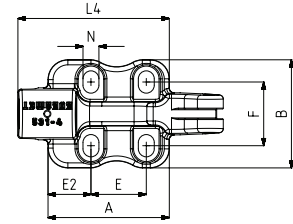

MODEL NO : 531-4

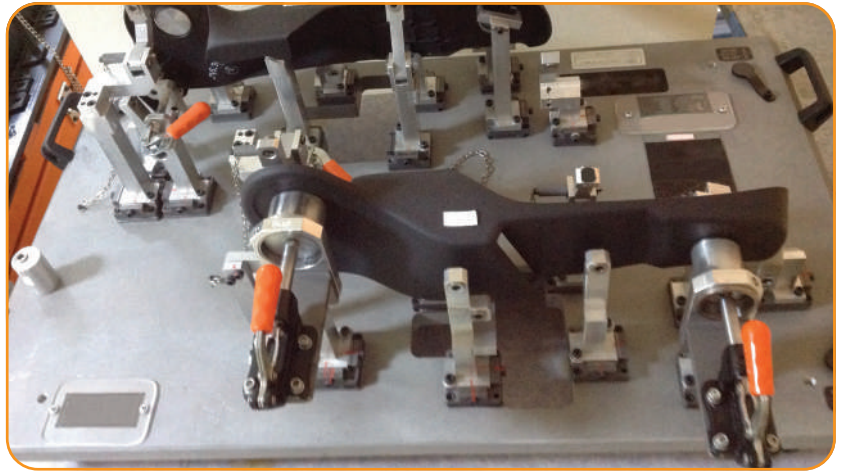
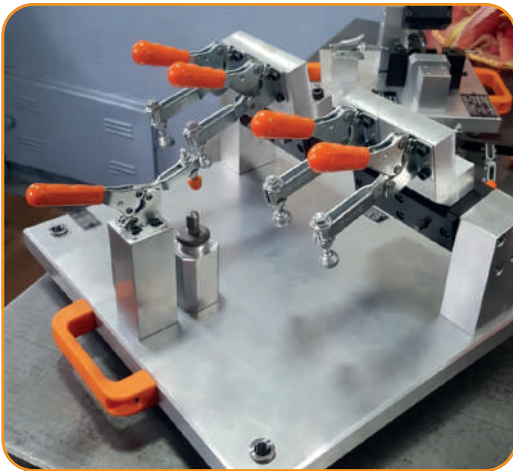

MODEL NO	A	B	E	E2	E3	F	G	H	H2	J	K	L	L2	L3 Min	L3 Max	L4	N
531 - 3 (Ø 12)	67	58	37	19,5	-	38	32	88	142	12	M8	155	85	24	58	85,5	7 x 12
531 - 3 (Ø 14)	67	58	37	19,5	-	38	32	88	142	14	M8	155	85	24	58	85,5	7 x 12
531 - 4 (Ø 16)	76	68	34,5	27	-	40	39	107	179	16	M10	187	105	32	81	95	10 x 14
531 - 4 (Ø 18)	76	68	34,5	27	-	40	39	107	179	18	M10	187	105	32	81	95	10 x 14
531 - 5 (Ø 20)	107	79	68	23	38	45,5	47	125	216	20	M12	235	125	39	94	134	11 x 22