

K KA PROFİL

**SÜRDÜRÜLEBİLİR
ÇELİK PROFİL ÇÖZÜMLERİ**

**SUSTAINABLE
STEEL PROFILE SOLUTIONS**

U-PVC

**REINFORCEMENT
STEEL PROFILE
CATALOGUE**

G - Shape Steel Profiles

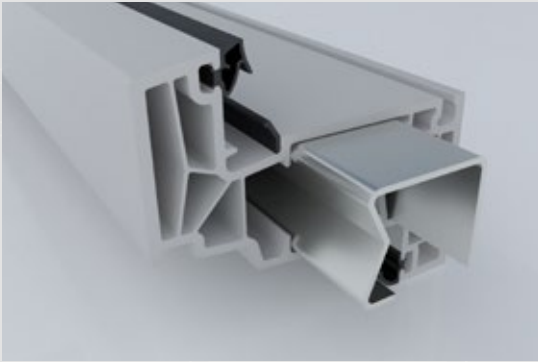

	min (mm)	max (mm)
A	15	65
B	5	30
C	5	30
H	25	60
T	0,7	2,5

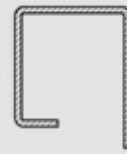
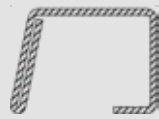
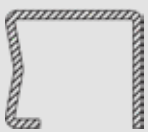
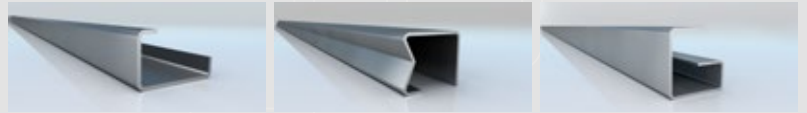
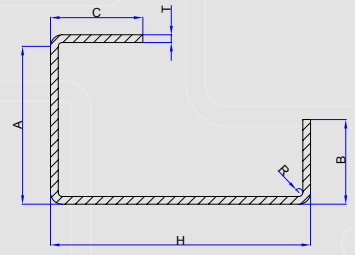

C - Shape Steel Profiles

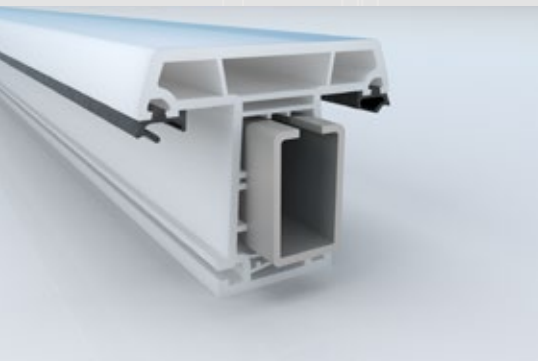

	min (mm)	max (mm)
A	10	65
B	10	65
C	5	20
D	5	20
H	20	50
T	0,60	2

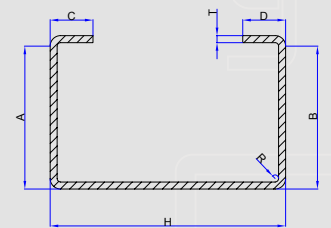

J - Shape Steel Profiles

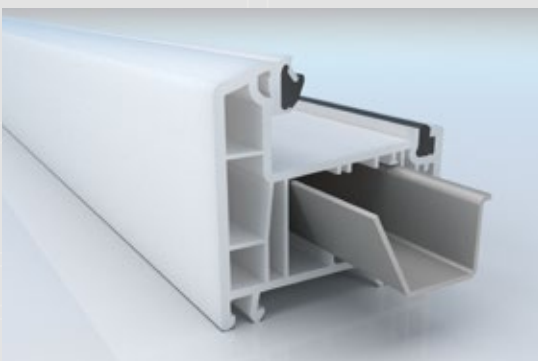

	min (mm)	max (mm)
A	15	65
B	8	65
H	10	65
T	0,6	2,5

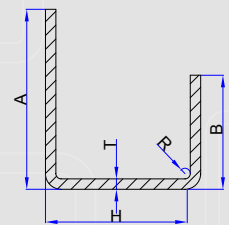

U - Shape Steel Profiles

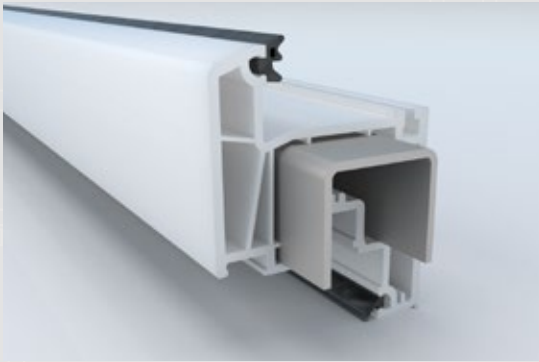

	min (mm)	max (mm)
A	8	65
B	8	65
H	10	90
T	0,6	2,5

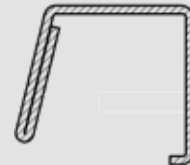
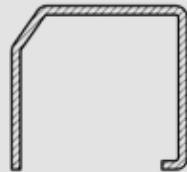
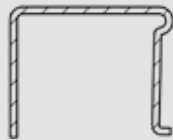
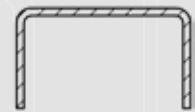
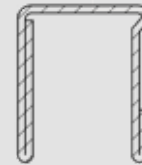
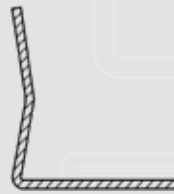
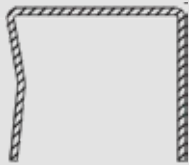
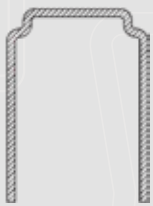
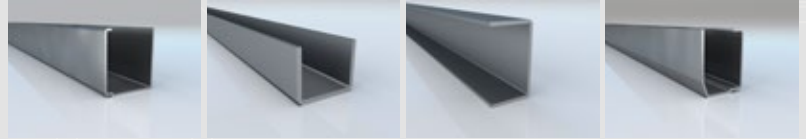
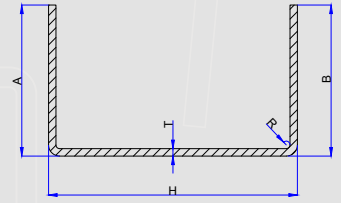

Box - Shape Steel Profiles

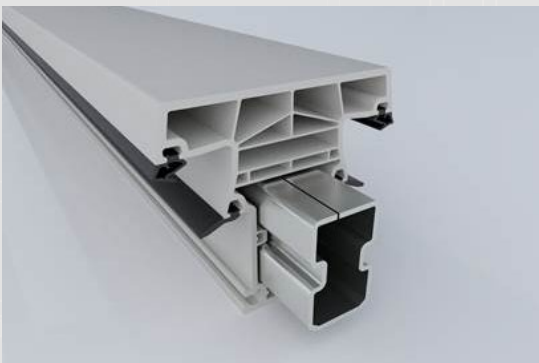

	min (mm)	max (mm)
A	10	60
B	10	60
C	5	25
D	5	25
H	10	50
T	0,8	2

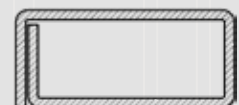
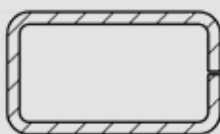
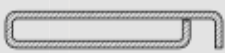
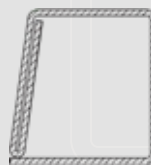
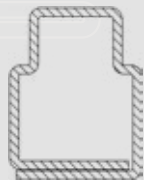
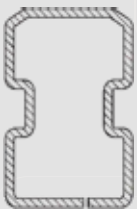
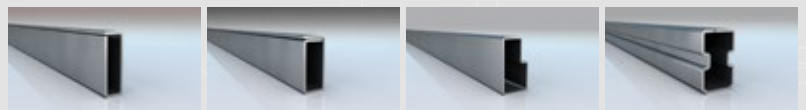
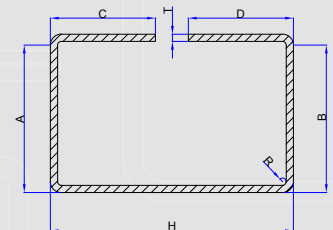

KA PROFİL

Sustainable
Steel Profile Solutions

U-PVC

REINFORCEMENT STEEL PROFILE CATALOGUE

KA PROFİL SANAYİ VE TİCARET LTD. ŞTİ.
İstiklal Mah. Cumhuriyet Cad. Zafer Sok. No:6
Kıraç Esenyurt / İstanbul

T: +90 (212) 689 82 72
T: +90 (533) 157 82 72

info@kaprofil.com

kaprofiltd

OUR REFERANCES

KÖMMERLING



REHAU

aluplast

GEALAN

FIRATPEN

SCHÜCO

VERATEC

ADOPEN

ERPEN

deceuninck

KOMPEN

PIMAPEN
Pencereye Adım Veren

winsa
PVC PENCERE - KAPI - PANJUR SİSTEMLERİ

SALAMANDER
INDUSTRIE // PRODUKTE

EGE PEN
deceuninck

winhouse

ASAŞ

EUROPEN

www.kaprofil.com