

Your Extrusion Allies

 **bausano**

EXTRUSION LINES



Extrusion lines

designed for
your factory

High Technology Plastic Extrusion Lines

Made in Italy Quality

Choosing Bausano means pick out a strategic partner that can help you to process plastics. We design and manufacture customised extrusion lines completely MADE IN ITALY for the production of pipes, granules, profiles, medical tubes and pockets in thermoplastic materials. The quality of the extruders and the products is unquestionable: the best technology at the service of the plastic industry, to improve productivity and reduce energy consumption.

For over 70 years Bausano has been synonymous with excellence in the field of plastic extruders. A result that we have attained with commitment, professionalism, and with a passion that has been handed down for three generations.

Our extrusion lines stand out not only for their quality, great solidity and extreme reliability, but also for the possibility of customising every part and every single detail, including aesthetics.

From the very beginning we decided to think outside of the box, and constantly opened ourselves up to renewal with enthusiasm, a desire to improve and with our mind always turned towards the future.

This has led us to overcome our limits, developing pioneering solutions over time capable not only of increasing the efficiency of the machines, but also of improving the working conditions of people.

Today, the challenge is sustainability. A difficult, urgent challenge that affects everyone, especially those working in this industry. Every effort must be focused on reducing our impact on the environment, starting with limiting waste and energy consumption and continuing through the promotion of research and the use of sustainable materials.

With the technology of our extrusion lines, we want to offer effective solutions and all the tools necessary to grow in a conscious and responsible manner.

Tools for
tomorrow's
industry

Quality made at Bausano

In-house production

Making efficient extrusion machines is a delicate operation and there are many variables involved, many of which can be unexpected. That is why we have always managed everything directly, taking care of every phase, from the initial project to the finished product.

A model that allows us to do better, clearly reducing the timescale and ensuring maximum quality at the technical-functional level while guaranteeing special attention, even when it comes to product design.

For us, work doesn't conclude with the sale, but continues within a long-term collaboration aimed at constantly improving on-site production lines, in a virtuous cycle that generates value by creating development.

SCREWS

Designing tailored screws to best respond to different production needs, is the first step to obtaining highperformance extrusion machines. Through computerised calculation our technicians analyse the plastic melt and measure the effect of physical and chemical stress. The result is a screw geometry design that works optimising motor power and heating system efficiency whilst simultaneously minimising waste and increasing the equipment's overall productivity.

BARRELS

To obtain optimal results For the barrels we use a special nitriding steel and, if there's a special requirement for it, we also make bimetallic barrels with inner sleeves in special alloys.

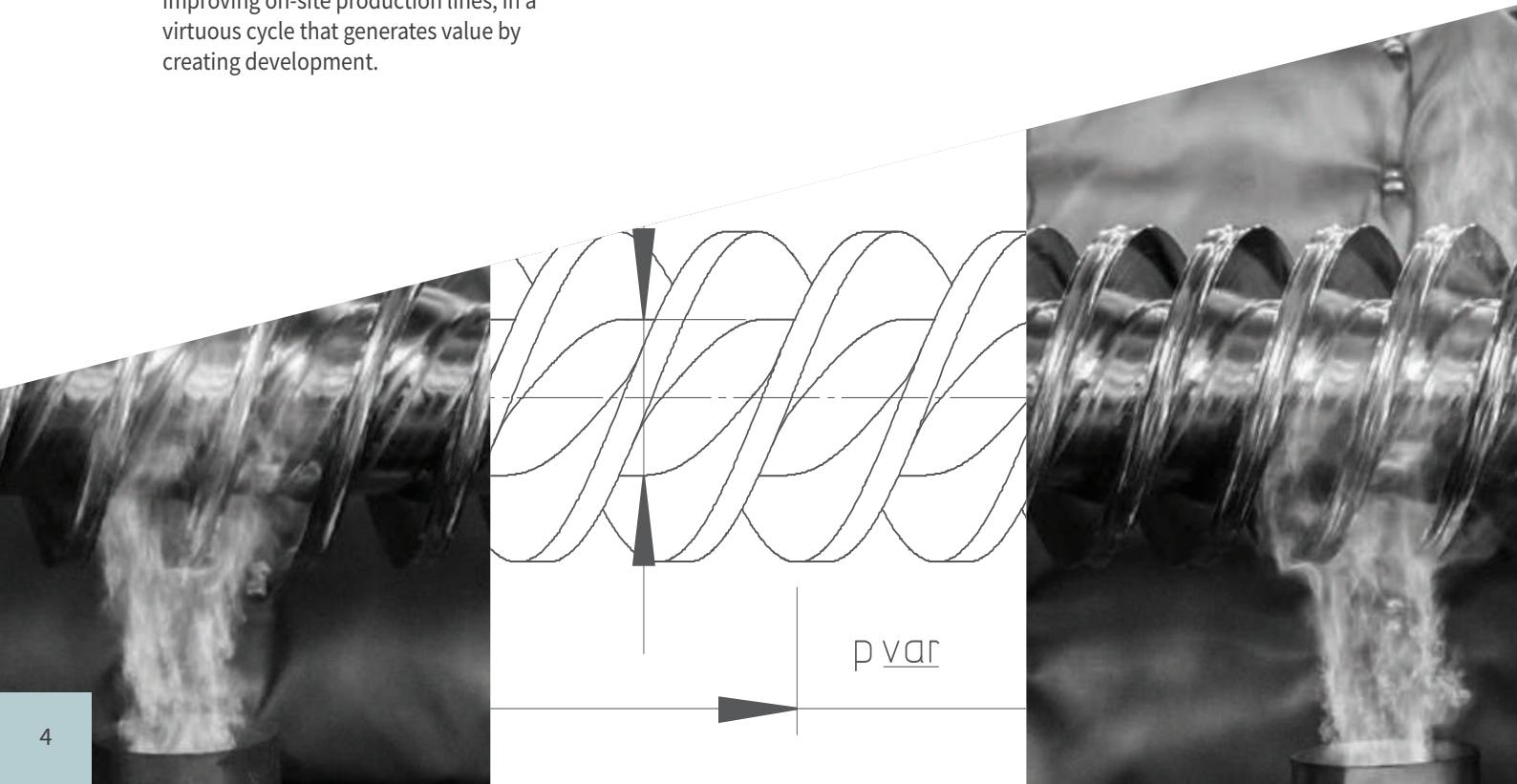

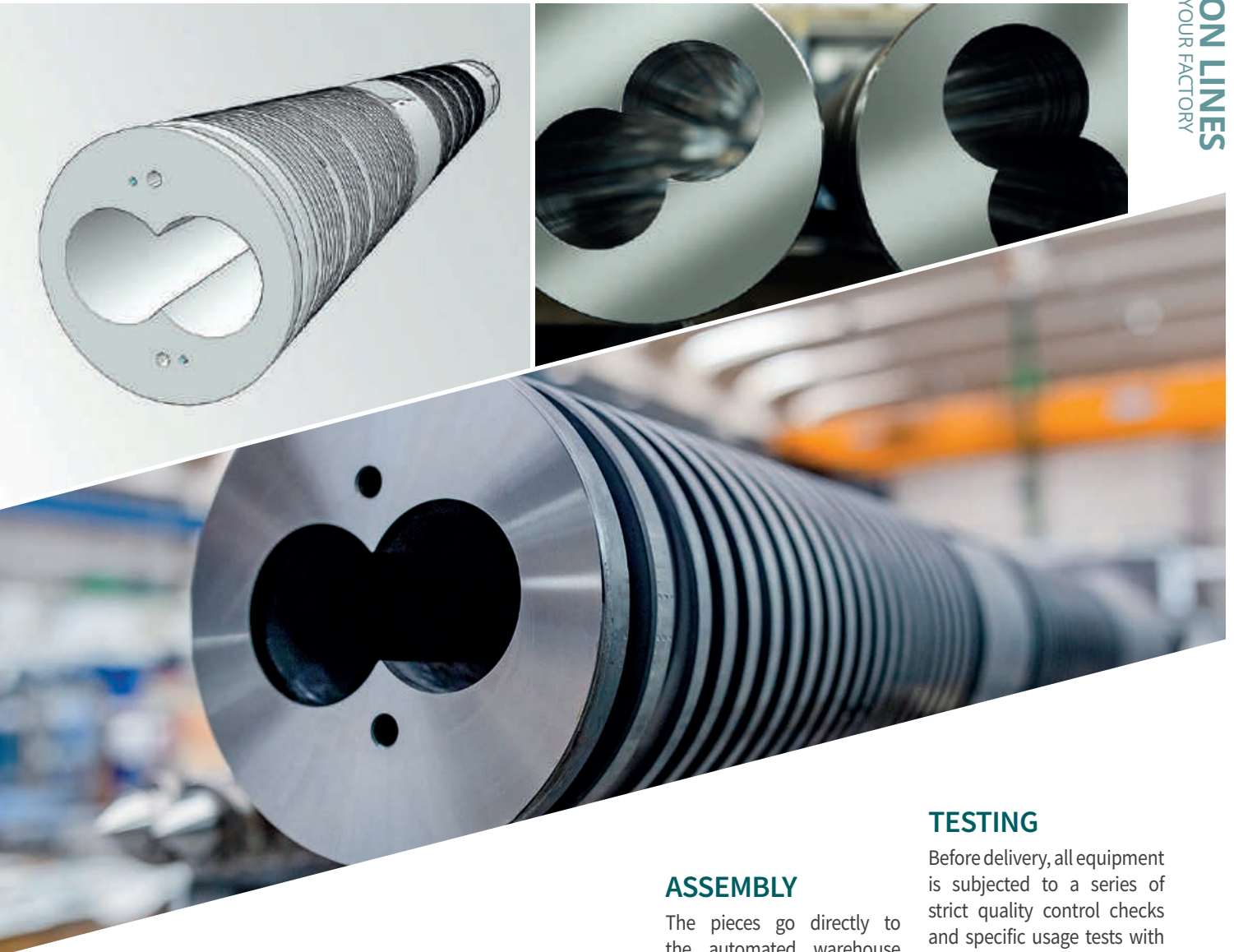

DESIGN

We listen to your requests and evaluate your needs: every single piece is custom designed and carefully planned, all the way down to the material to be processed and the production specifications, including screws, barrels and transmission boxes.

PRODUCTION

All the components for our extruders, calibration benches, cooling units, cutters and other downstream accessories are made in our machine tool department, all customised up to the smallest detail.

ASSEMBLY

The pieces go directly to the automated warehouse that distributes them to the operators in the assembly department where our extrusion lines finally take shape.

TESTING

Before delivery, all equipment is subjected to a series of strict quality control checks and specific usage tests with the materials it's intended to be used for. This enables us to assess its suitability and compliance with the project.

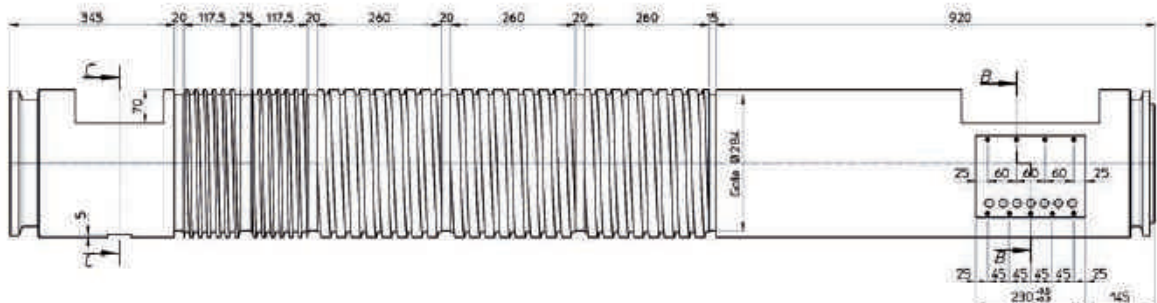

Fields of application

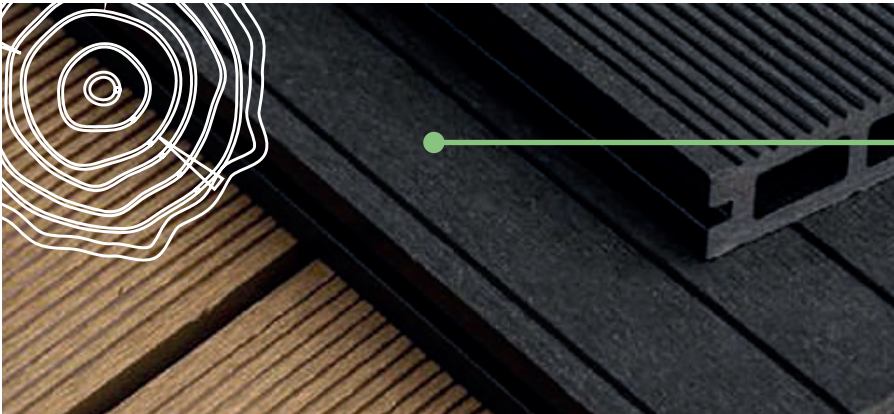

WPC DECK and FLOOR

POLYWOOD technology allows us to obtain profiles composed of up to 80% natural fibres: more sustainable, cheaper, stronger and more versatile than wood but with the same aesthetic appeal and completely recyclable. A new frontier in the field of building materials.

PRODUCTS

With Bausano's single and twin-screw extruders and a wide range of accessories, it is possible to create highly efficient, customised production systems for processing PVC and other materials permitted by Pharmacopoeia regulations, designed to meet the high quality standards of the industry.



TECHNICAL PROFILES

The MULTIDRIVE system of our MD Plus and Nextmover extruders provides our lines with great reliability and high performance for the production of rigid and flexible profiles having variable weight and size - from a few grams to several kilograms/meter.

PO and PVC PIPES

Taking advantage of the power and versatility of the E-GO and MD extruder family, we design and manufacture complete lines for the production of PVC, HDPE, LDPE, PE100 and PP pipes for any application: single-layer and multi-layer, smooth and corrugated, rigid and flexible, with a diameter of up to 1,600 mm.

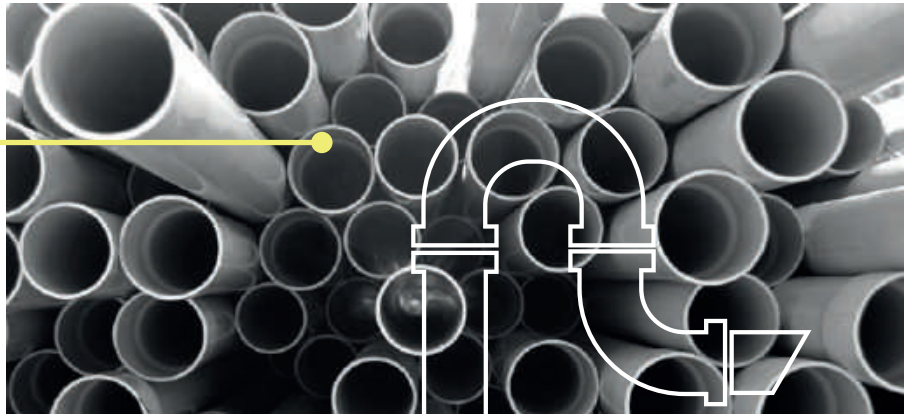

PELLETS AND COMPOUNDS

Fully customisable and high performing at any speed of production – thanks to MD technology and Bausano accessories – our lines obtain granules for subsequent moulding, extrusion or calendaring, from virgin or recycled material.

RECYCLING and REGRANULATION

In order to make plastic recycling a standard practice, many factors need to add up: from product design to collection to sorting and processing.

Bausano E-GO single-screw extruders and MD twin screw extruders are designed to reprocess a variety of plastic scraps – PVC, HDPE, TPR, PA, PS, ABS and many others – ensuring utmost production efficiency and excellent performance over time.



The power of Saving

Smart technology for efficient production

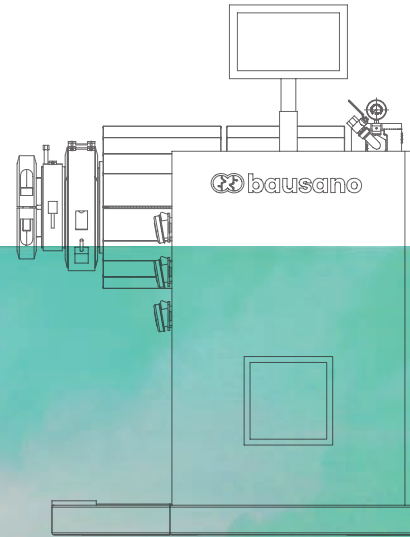

Energy: a resource to invest in consumption and sustainability

Extrusion is not only a final forming process but is also an intermediate process for other processing techniques such as injection moulding, blow moulding and film blowing. The efficient operation of extrusion is therefore essential to much of the plastics processing industry. The process is highly dependent on electricity and most of the energy used is directly related to machine operation.

Each of our projects develops from well-defined technical requirements and production targets that may differ from time to time. This is why each extruder is unique, even different from the others belonging to the same series. What never changes is the ability to optimise production, cutting down costs and passing any tests with exceptional results.

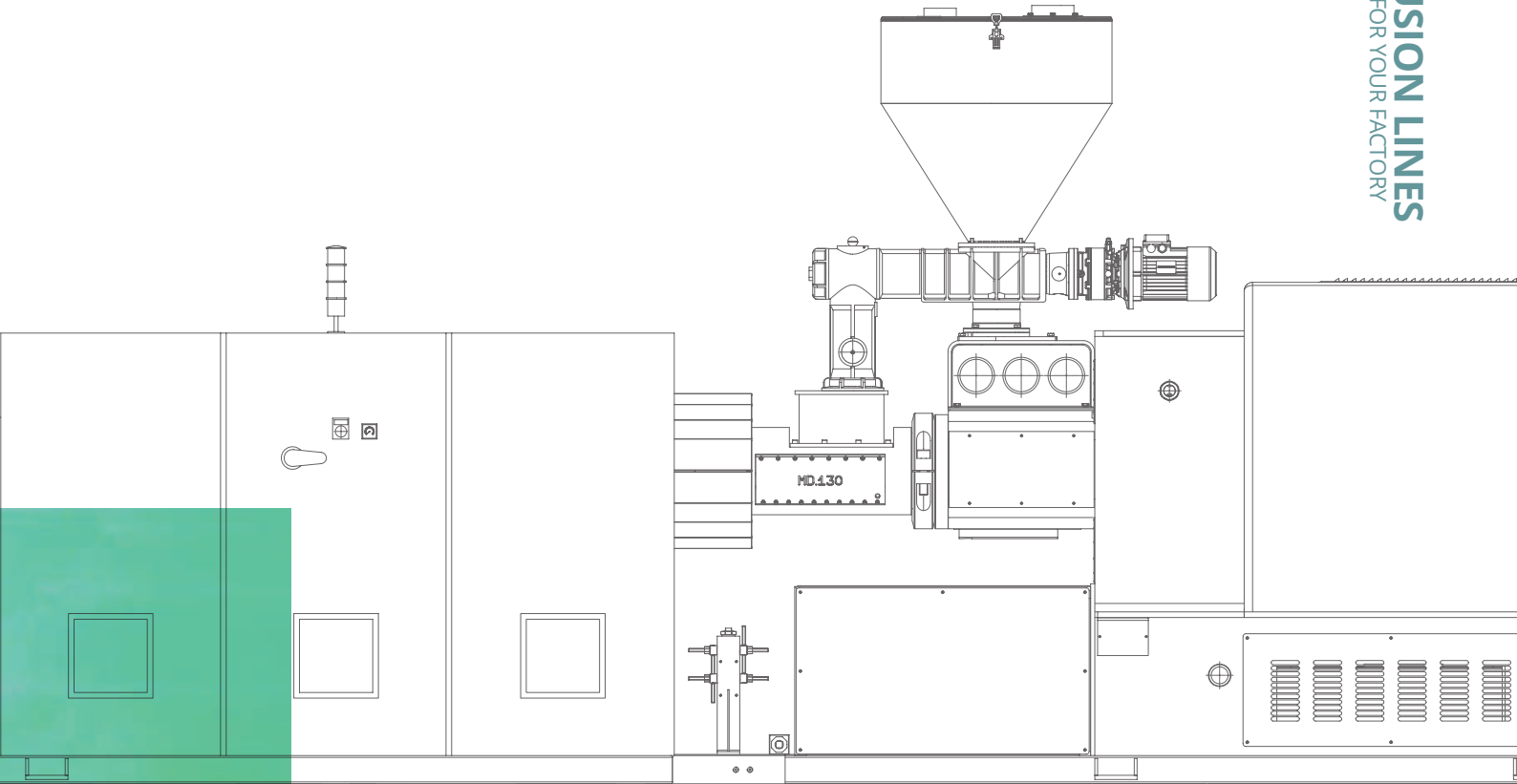

MD Nextmover TWIN-SCREW EXTRUDERS SERIES

Up to 35% less power consumption thanks to the innovative motors, Smart Energy System and real-time energy analysis of the entire system with the Digital Extruder Control 4.0 system.

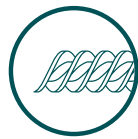

E-GO SINGLE-SCREW EXTRUDERS SERIES

Power, technology and elegance in a modular machine, customisable in every detail, complete with Digital Extruder Control 4.0 to monitor consumption.



E-GO R SINGLE SCREW RECYCLING LINES

The E-GO R Single Screw Extruder Series is the entirely new recycling and pelletizing system with optimized L/D ratio, filtering upstream of vacuum degassing, especially suited to plastic waste.

Twin-screw Extruders MD Nextmover Series

New Generation Extruder



THERMOCONTROLLED
SCREWS 1

VENTING 2

DOUBLE
JACKETED BARREL
PROTECTION 3

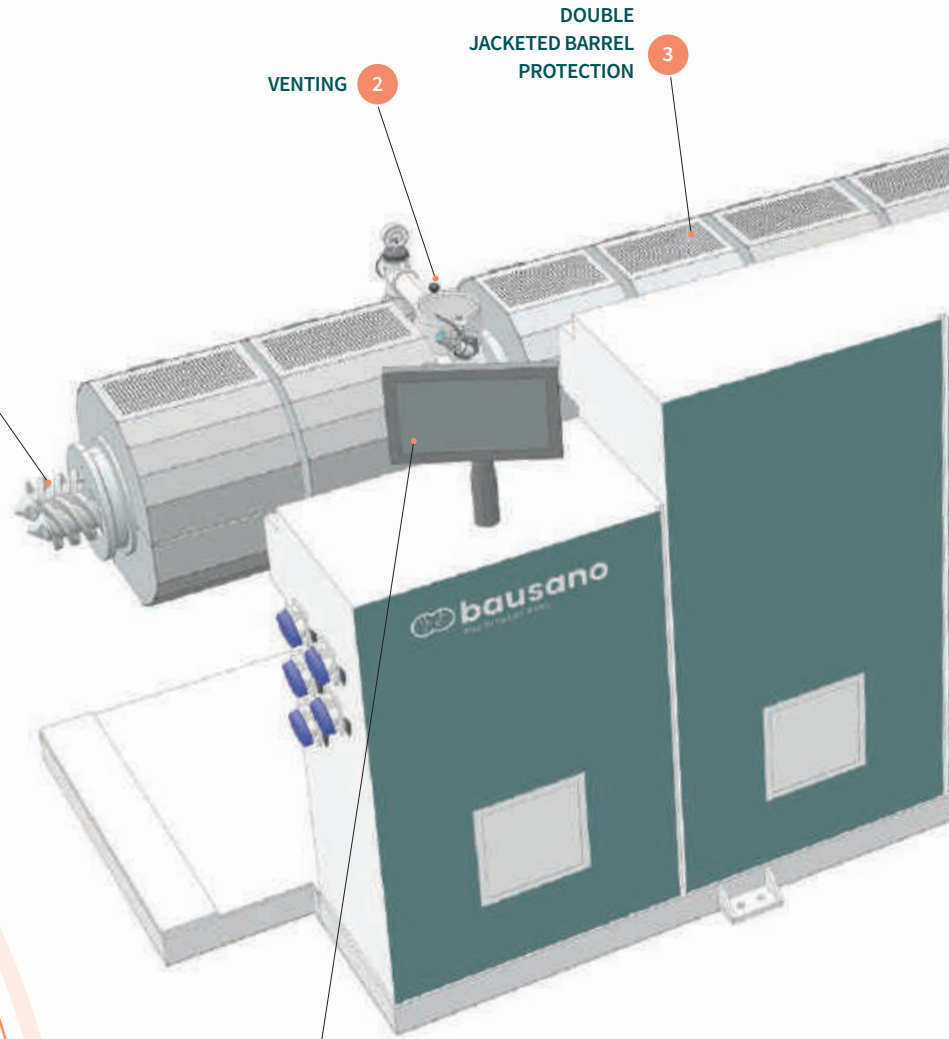

DIGITAL
EXTRUDER
CONTROL 4.0 9



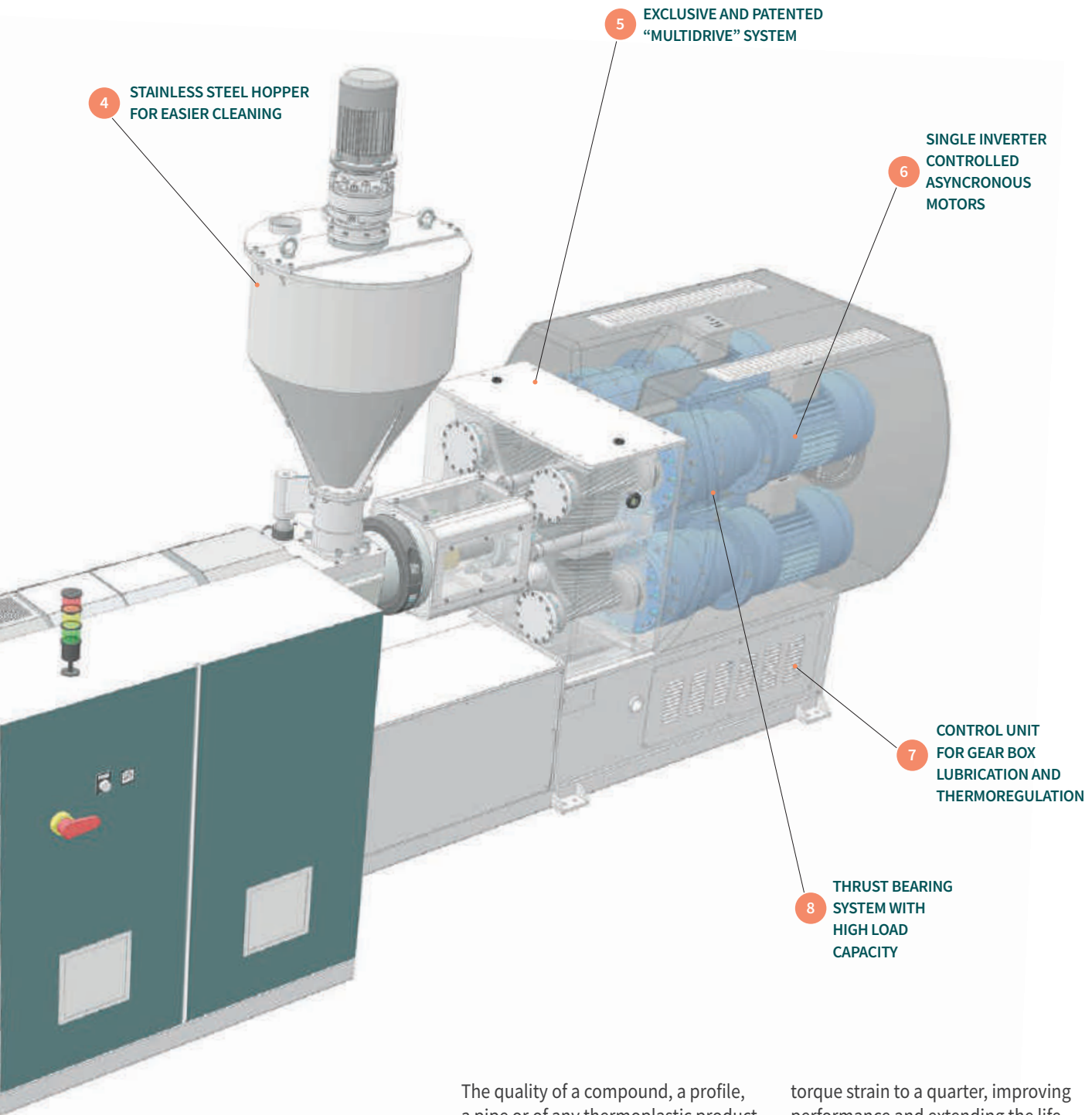

4 STAINLESS STEEL HOPPER FOR EASIER CLEANING

5 EXCLUSIVE AND PATENTED "MULTIDRIVE" SYSTEM

6 SINGLE INVERTER CONTROLLED ASYNCHRONOUS MOTORS

7 CONTROL UNIT FOR GEAR BOX LUBRICATION AND THERMOREGULATION

8 THRUST BEARING SYSTEM WITH HIGH LOAD CAPACITY

The quality of a compound, a profile, a pipe or of any thermoplastic product is the result of the extrusion line that generated it. That's why for us there are no secondary details and every aspect, from mechanics to electronics, must be designed and manufactured with the utmost care.

Screw geometry designed to reduce friction and improve efficiency; a transmission system capable of cutting

torque strain to a quarter, improving performance and extending the life of the system; the latest generation motors and a valuable, simple and intuitive tool for analysing power consumption.

Elements that translate into greater production and energy efficiency. A double advantage that makes our lines the safest and most innovative solution in the field of extrusion.

Cooling System

Temperature is the secret for a professional extrusion process.

The correct thermoregulation of the barrels and screws is the key to obtaining high-quality extruded products. That's why we have developed an advanced, efficient cooling system, reliable at any production speed.

INTERNAL SCREW THERMOCONTROL

Automatic adjustment of the internal temperature of the screws through a closed circuit or a temperature control unit.

HIGH-EFFICIENCY AIR COOLING

Automatic adjustment of the barrel temperature through air fans.

HIGH-PERFORMANCE OIL COOLING

The specific solution for lines with high production volumes, is the cooling of the barrel by a circuit containing temperature-controlled fluid.



Dosing System

Thanks to the versatility of Bausano extruders, it is possible to equip each machine with customized feeding systems. This ensures adjusting the layout of the line and its technical characteristics to the material to be processed and to any specific production requirement.

FORCED FEEDER

The speed control system can adjust the amount of material, avoiding uneven feeding distribution.



COMBINED FEEDER

This combines a Forced and Volumetric hopper, ensuring high accuracy and efficient feeding.



VOLUMETRIC FEEDER

This supplies a certain volume of material per unit of time in a precise way.



GRAVIMETRIC FEEDER

This supplies an exact quantity of material per unit of time.





LONGER LIFE
of shafts and gear,
thanks to the
distribution of
motion on four or two
different points.



MORE POWER
available on the
screws with the same
power output from the
motors, for significant
energy savings.



**LOWER
CONSUMPTION**
with the same
performance,
thanks to the torque
distribution on the
two control shafts.

Multidrive System 4x2

The Technological Evolution of Bausano

The MULTIDRIVE transmission system has been a benchmark technology in the world of extruders for thirty years, reducing the stress on the drive shaft, gears and screws by distributing the torque through one or two pairs of counter-rotating motors.

A revolutionary solution, which offers better performance, reduces the risk of failure due to excessive stress on the mechanical parts and guarantees greater durability than traditional single-motor systems.

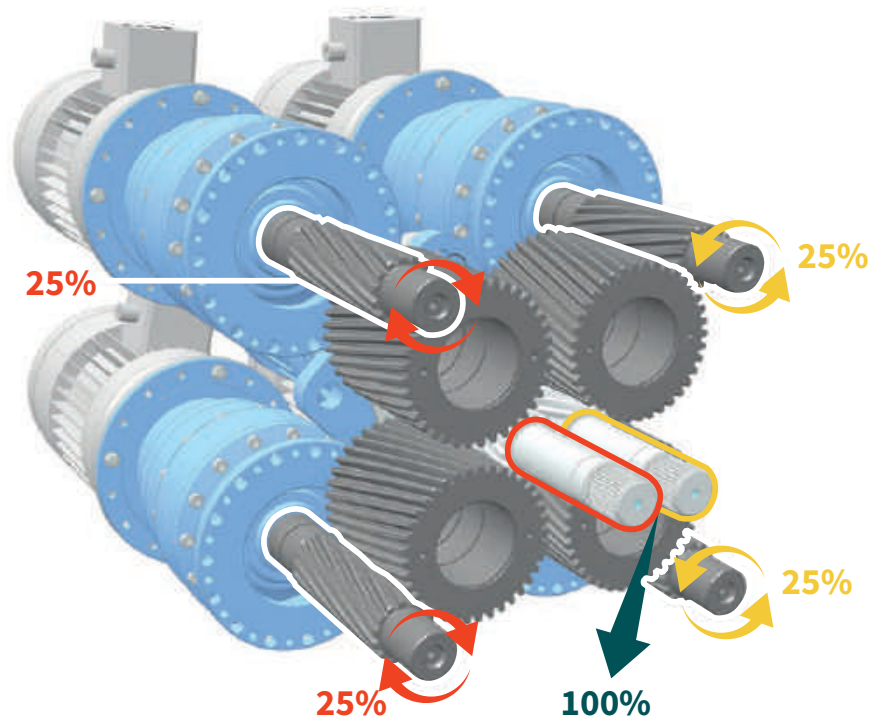

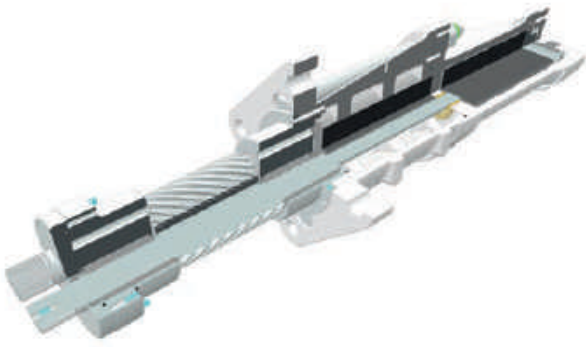

THRUST BEARING SYSTEM

Bausano counter-rotating twin-screw extruders are equipped with special multi-stage thrust bearings, designed to triple the dynamic load, improving the overall efficiency of the machine and making MD Plus and MD Nextmover ideal for managing high production volumes.

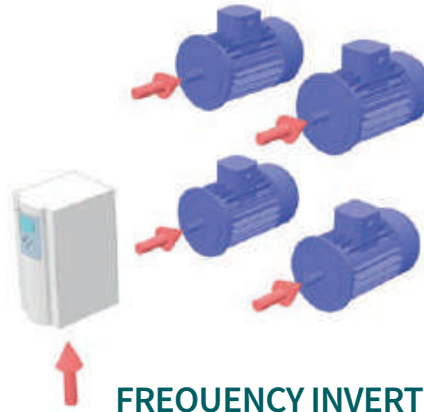

FREQUENCY INVERTER

In all our MULTIDRIVE extruders, the motors are managed by a single static frequency inverter - a reliable, versatile and highly precise instrument, capable of making rotation constant and increasing the overall efficiency of the machine.

- Perfect synchronisation of the motors, without using expensive and delicate devices
- Always optimal power distribution
- Significant energy saving
- Lower installation and maintenance costs
- More solidity and longer service life over time

Multidrive System 2x2

Small Size, High Performance

For the smaller extruders we have created MULTIDRIVE 2x2, fitted on models MD 30, MD 52, MD 66 and MD 75. With two motors instead of four, the system allows minimising the overall dimensions, optimising the operation of the gear box and ensuring top-class performance and reliability.

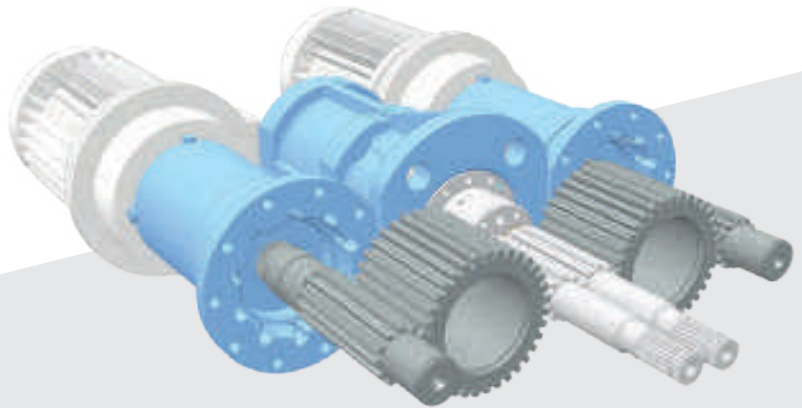

Induction Heating System

An Energy Saving Technology



THE BENEFITS:

- Maximum energy efficiency with savings up to 35%
- Faster barrel heating and cooling
- Increased machine durability
- Even heat distribution
- Easy installation and maintenance



TRADITIONAL VS INDUCTION System comparison

For us, the ability to innovate has always been the most important strategic resource: this is why we were the first to apply the principle of electromagnetic induction to extrusion machinery at an industrial level.

Unlike traditional resistance-based systems, the barrel is heated without contact by an alternating electromagnetic field: a faster and more efficient method, which guarantees top performance by significantly reducing component wear and energy consumption up to 35%.

Bausano Smart Energy System is the effective answer to a concrete need: the optimisation of production processes with a view to sustainable development, respecting people and the environment.

Areas	Resistance system MD 130							Induction system MD 130			
	Rated power			Interval control (sec)	Time on (sec)	% time on (sec)	Absorbed power (kWh)	Power reduction (%)	Absorbed power (kWh)	Energy saving kWh	Energy saving %
	No. of heating intervals	Power intervals in Watts	Total area power in Watts								
1	1	10,000	10,000	60	36	60	6	30	4.2	1.8	30
2	3	5,000	15,000		30	50	7.5		5.25	2.25	
3	3	5,000	15,000		30	50	7.5		5.25	2.25	
4	1	7,500	7,500		12	20	1.5		1.05	0.45	
5	1	7,500	7,500		12	20	1.5		1.05	0.45	
6	1	6,000	6,000		12	20	1.2		0.84	0.36	
7	1	6,000	6,000		12	20	1.2		0.84	0.36	
8	1	7,500	7,500		12	20	1.5		1.05	0.45	
9	1	7,500	7,500		12	20	1.5		1.05	0.45	
Total areas >>			82,000				29.4		20.58	8.82	

Energy saving forecasts - Calculation of depreciation

Hours of system operation	h/year	B	6,000
Energy cost	€/kWh	C	0.14
Energy saving	€/year	D = A*B*C	7,409

Estimate calculated for active production cycle, based on estimated consumption of every single area, considering areas 4 to 9 active for 20% of the time.

A model of efficiency

Consumption and Sustainability

Each of our projects derives from well-defined technical requirements and production targets that may differ by case. This is why each extruder is unique, even different from the others belonging to the same series. What never changes is the ability to optimise production, cutting down costs and passing any tests with exceptional results.

As an example, we selected some in-house tests conducted on our machines to provide a performance index, by comparing installed power values (kW) and motors.



MODEL	INSTALLED POWERS	MOTOR CONSUMPTION
MD 66/19 Plus	Ceramic resistors 20 kW	low-efficiency motors
MD 66/19 Nextmover	Smart Energy System 14 kW	I.E. high-efficiency motors
Difference	- 6 kW	Energy Saving - Motors - 5%*
MD 130/30 Plus	Ceramic resistors 124 kW	low-efficiency motors
MD 130/30 Nextmover	Smart Energy System 98 kW	I.E. high-efficiency motors
Difference	- 26 kW	Energy Saving - Motors - 5%*
MD 158/21	Ceramic resistors 88 kW	low-efficiency motors
MD 158/21 Nextmover	Smart Energy System 61 kW	I.E. high-efficiency motors
Difference	- 27 kW	Energy Saving - Motors - 5%*
MD 170/28	Ceramic resistors 192 kW	low-efficiency motors
MD 170/28 Nextmover	Smart Energy System 124 kW	I.E. high-efficiency motors
Difference	- 68 kW	Energy Saving - Motors - 5%*

* Motors running at 50 HZ, 380V

Industry 4.0

Orchestra 4.0 Control System



Orchestra is the centralized 4.0 control system for the analysis of Real Time production data.

Smart factory

The world is facing the 4th industrial revolution, in which computers and automation will come together, in an entirely new way, with robotics connected remotely to computer systems equipped with machine learning algorithms, that help us **identify production inefficiencies**.

The approach to transforming the process industry into a 4.0 model, or “**smart factory**”, is based on synergistic work between plant manufacturers and the companies that use them. **Your company** is in good health, it runs, invests in and **needs a control system** that keeps pace with its new requirements.

In this regard, Bausano supports its customers with **the implementation and the integration of systems aimed at supporting the new digital industrial revolution**, providing plastic manufacturers with complete and integrated range of solutions, industrial softwares and technologies.

It means equipping **your own extrusion systems with a centralized control system** that calculates the performance indices and analyses Real Time production data.

Efficient production planning

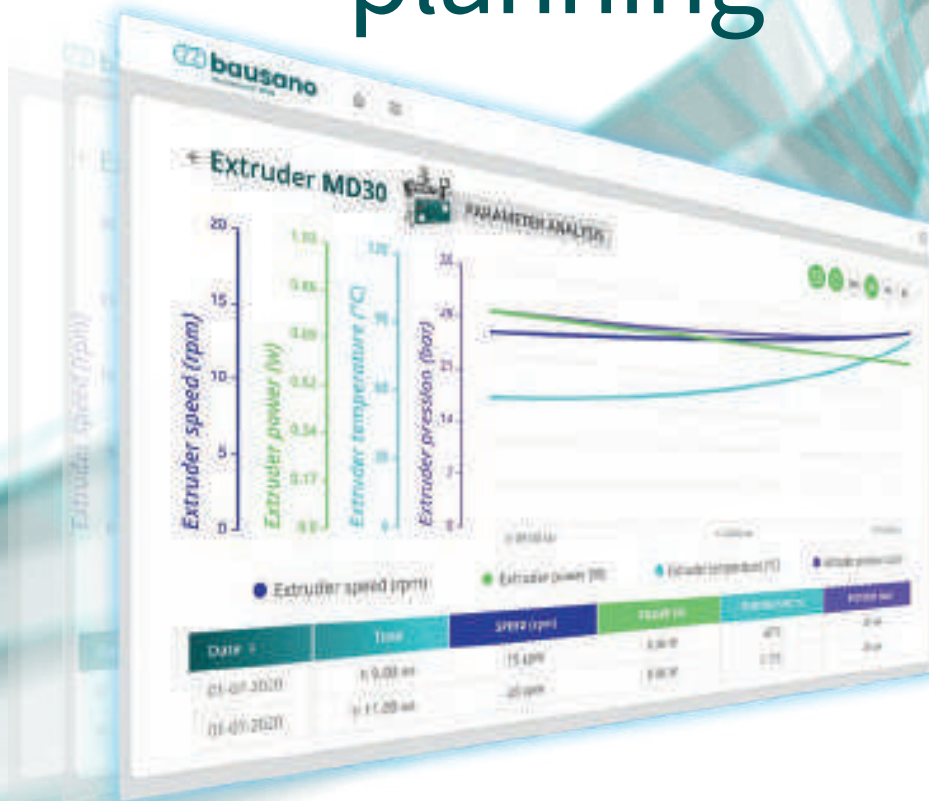

PARAMETERS

- ✓ Thermoregulation Zones
- ✓ Temperature
- ✓ Screws Rpm
- ✓ Energy Consumptions
- ✓ Thrust Pressure (Ton)
- ✓ Extruder Pressure (Bar)
- ✓ Extruder Motors Speed
- ✓ Extruder Melt Pressure
- ✓ Extruder Melt Temperature
- ✓ Alarms Management
- ✓ Production Recipe

Innovative technologies are bound to become a model to be followed for the entire sector, designed to raise the quality standard of processes and of the final product, offering important strategic resources and new development opportunities:

- monitor **all extrusion parameters** in real time, also in remote mode.
- programme the **automatic synchronism for production**, maintenance and diagnostics;
- save the configuration of the memory module;
- **save the selected parameters**, upon request or at preset intervals.

Predictive Maintenance



Predictive maintenance for **industry 4.0** is a method of preventing asset failure by analyzing production data to identify patterns and **predict issues before they happen**.

Until now, factory managers and machine operators carried out **scheduled maintenance** and regularly repaired extruders parts to prevent downtime.

Implementing industrial **IoT technologies** to monitor asset health, optimize maintenance schedules, and gaining real time alerts to operational risks, allows manufacturers to lower service costs, maximize uptime, and improve production throughput.

- **Flexibility**
Efficient Production;
- **Profitability**
Optimized Processes;
- **Safety**
Prevents Defects;
- **Productivity**
Eliminate Errors and waste.

Corrective Maintenance

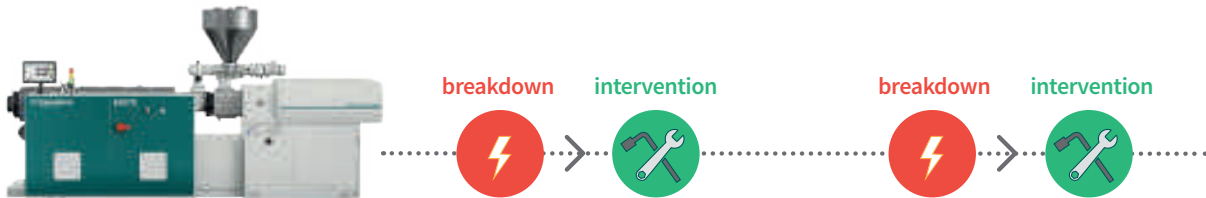

Preventive Maintenance

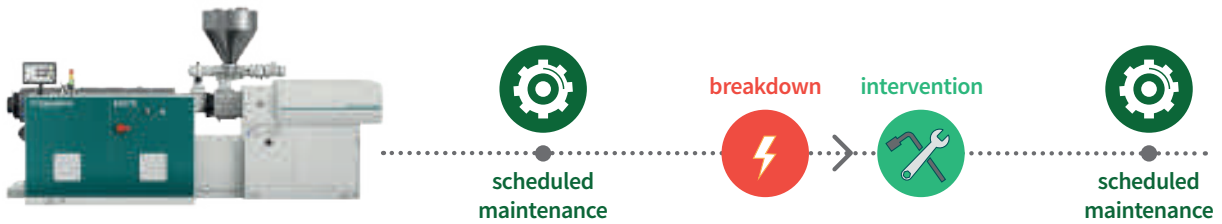

Predictive Maintenance



Being able to remotely access the data relating to the operation of the extruder allows us to:

- Report any anomalies that could lead to a machine stop or imminent damage;
- In the case of technical interventions carried out by remote assistance, the Bausano technician has a better perspective of the operating status of the machine which translates into a better intervention strategy;
- Thanks to the data analysis we can give you advice on values to be monitored to improve the quality of production (consultancy service).

MD Bausano Series

Twin Screw Extruders



MD 30

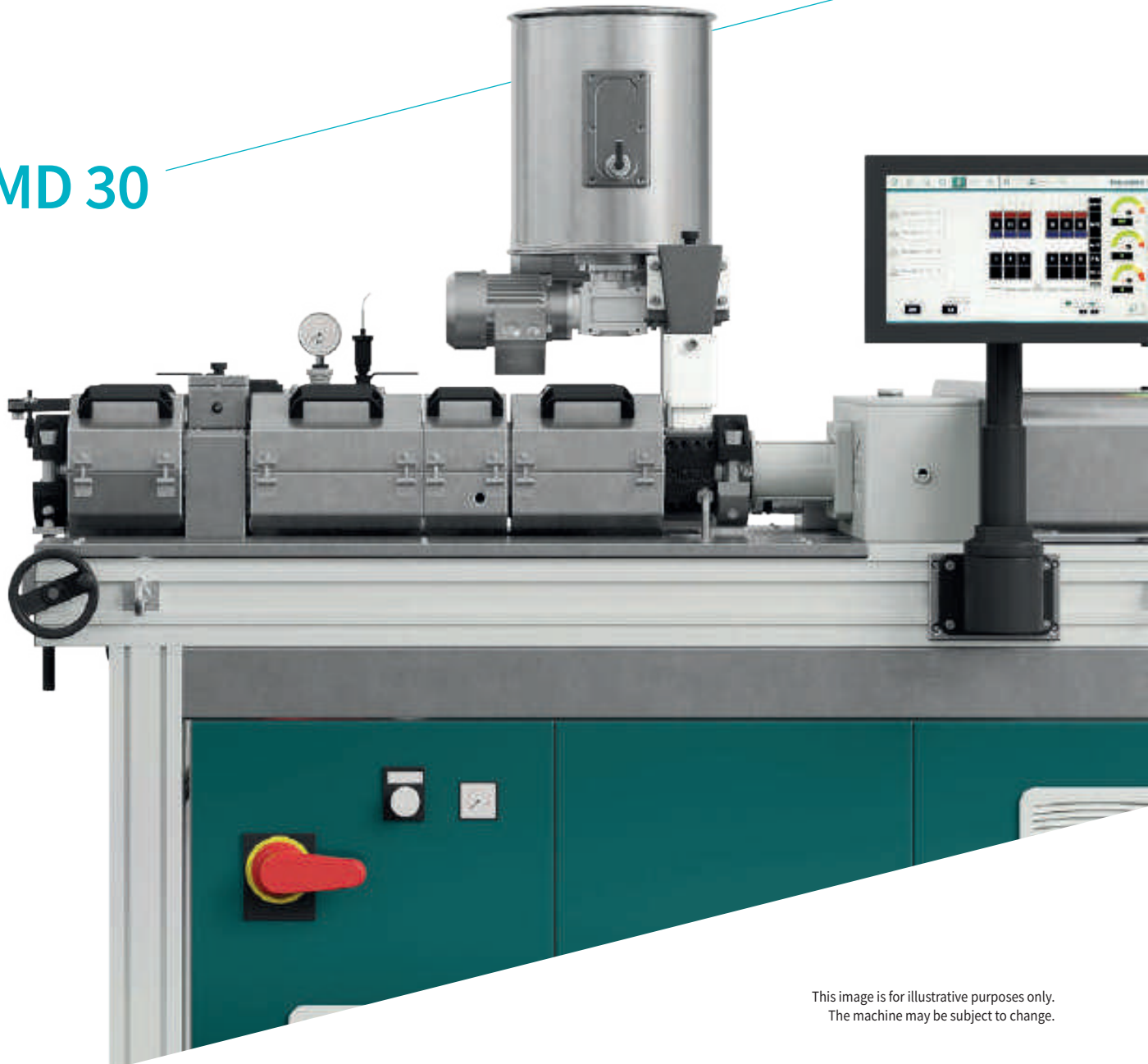

This image is for illustrative purposes only.
The machine may be subject to change.



Compact, versatile and perfect for testing and sampling operations, the special extruder Bausano MD 30 is designed for those who need to analyse products and manage pilot tests in the laboratory on small quantities of material, with the aim of identifying solutions to be extended to the entire production.

Consisting of one or two inlets on a single barrel with side pressure probes, MD 30 allows you to process multiple materials with a single doser.

Equipped with wheels, the extruder can be easily moved and any inspection and cleaning operation is simple and fast, thanks to the wider degassing.

Moreover, the **Digital Extruder Control 4.0** allows:

- ⊕ monitoring all extrusion parameters in real time;
- ⊕ saving the configuration to the memory module;
- ⊕ programming the automatic synchronism for production, maintenance and diagnostics;
- ⊕ saving the selected parameters, upon request or at preset intervals.

TECHNICAL DATA

MD30/19

Motors	2x1.5 kW
Total installed power	11 kW

MD30/30

Motors	2x1.5 kW
Total installed power	12 kW

Data may vary according to design specifications.

MD Bausano Series

Twin Screw Extruders



MD 52
MD 66
MD 75

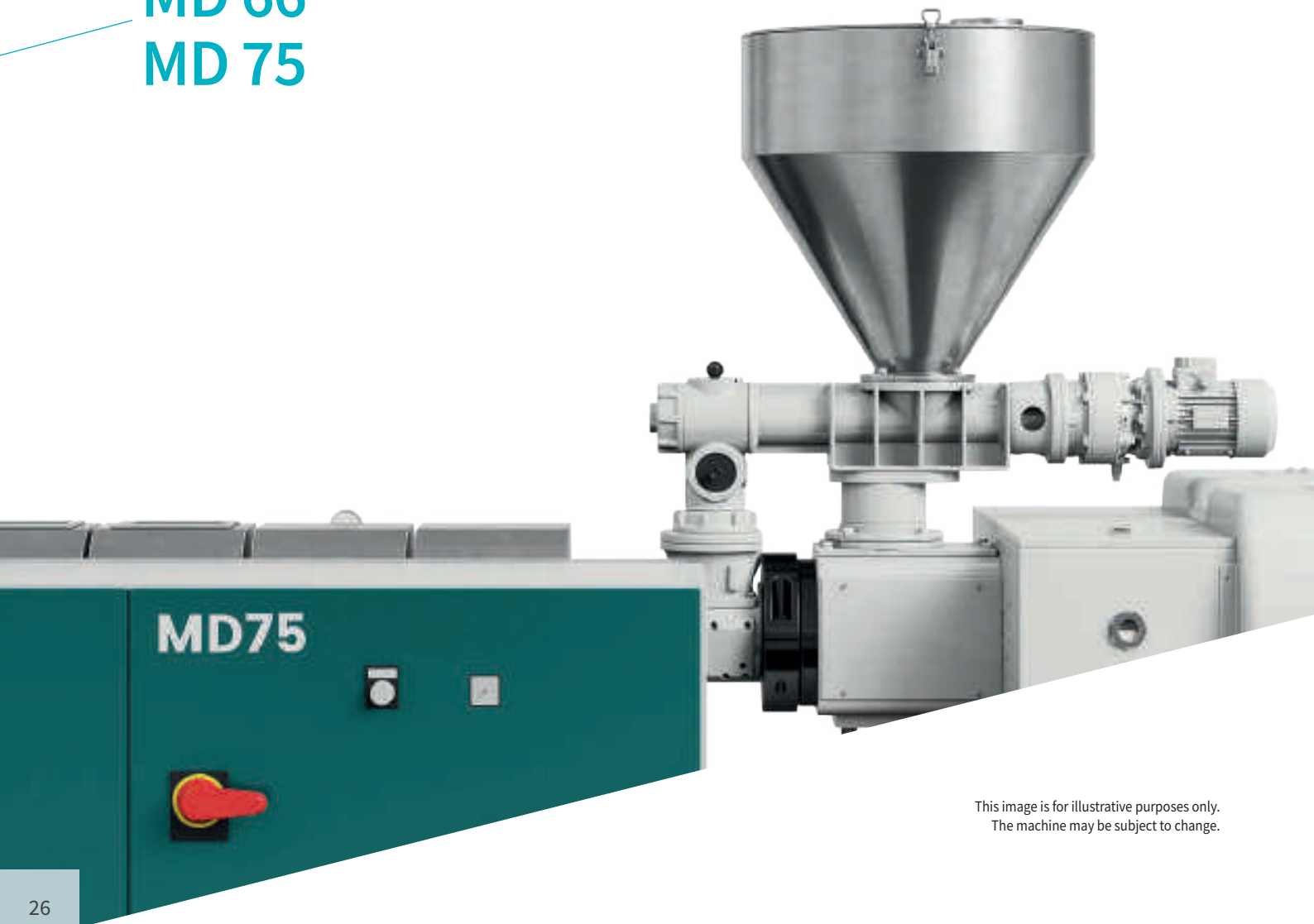

This image is for illustrative purposes only.
The machine may be subject to change.



TECHNICAL DATA

SCREWS

	MD 52	MD 66	MD 75
Diameter (mm)	52	66	75
Direction of rotation	Counter-rotating		
Rotation speed (rpm)	14 - 79	10-60	8-80
Thrust system dynamic load (kN)	410	694	694
Torque on each screw (Nm)	1780	2200-2750	3380-4100
Thermostating	Fluid-type		

BARREL

	MD 52	MD 66	MD 75
L/D ratio	23	19 - 30	24 - 30
Degassing	With vacuum pump		
Cooling areas	Air		

INSTALLED POWERS

	MD 52	MD 66	MD 75
Asynchronous extruder motor (kW)	2x7.5	2x7.5 - 2x9	2x15 - 2x22
Degassing pump motor (kW)	2.2	2.2	4
Total installed power (kW)	40	45 - 55	85 - 100
Average consumed power (kW/h)	18	20 - 25	34 - 40

Data may vary according to design specifications.

MD Bausano Series

Twin Screw Extruders



MD 92
MD 118
MD 130



This image is for illustrative purposes only.
The machine may be subject to change.



TECHNICAL DATA

SCREWS

	MD 92	MD 118	MD 130
Diameter (mm)	92	118	130
Direction of rotation	Counter-rotating		
Rotation speed (rpm)	8-65	8-45	8-45
Thrust system dynamic load (kN)	1680	2250	2830
Torque on each screw (Nm)	8105	18190	24700
Thermostating	Fluid-type		

BARREL

	MD 92	MD 118	MD 130
L/D ratio	25-30	20-26-30	25-30
Degassing	With vacuum pump		
Cooling areas	Air		

INSTALLED POWERS

	MD 92	MD 118	MD 130
Asynchronous extruder motor (kW)	4x15 - 4x18.5	4x22 - 4x30	4x30
Degassing pump motor (kW)	4	4	4
Total installed power (kW)	127-165	190-210	240-260
Average consumed power (kW/h)	60-70	95-105	120-130

Data may vary according to design specifications.

MD Bausano Series

Twin Screw Extruders



MD 158
MD 170

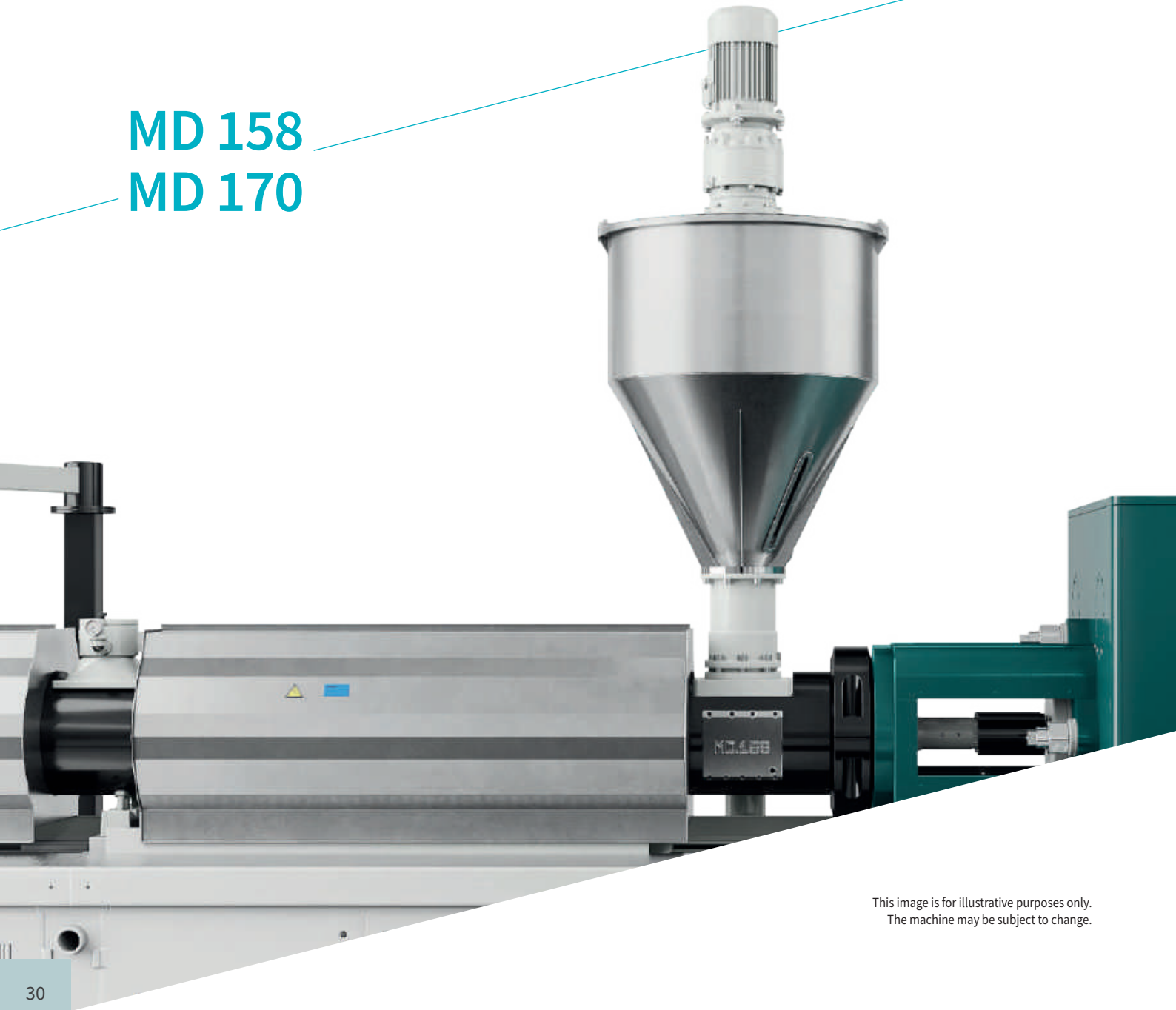

This image is for illustrative purposes only.
The machine may be subject to change.



TECHNICAL DATA

SCREWS

	MD 158	MD 170
Diameter (mm)	158	170
Direction of rotation	Counter-rotating	
Rotation speed (rpm)	8-38	8-45
Thrust system dynamic load (kN)	5085	5900
Torque on each screw (Nm)	36600	46960
Thermostating	Fluid-type	

BARREL

	MD 158	MD 170
L/D ratio	21-26-30	24-28
Degassing	With vacuum pump	
Cooling areas	Liquid	

INSTALLED POWERS

	MD 158	MD 170
Asynchronous extruder motor (kW)	4x37 4x45	4x55
Degassing pump motor (kW)	4	4
Total power (kW):	288-340	408-432
Average consumed power (kW/h)	125 - 140	200 - 215

Data may vary according to design specifications.

Single-screw Extruders E-GO Series

Powerful, compact
and cutting-edge

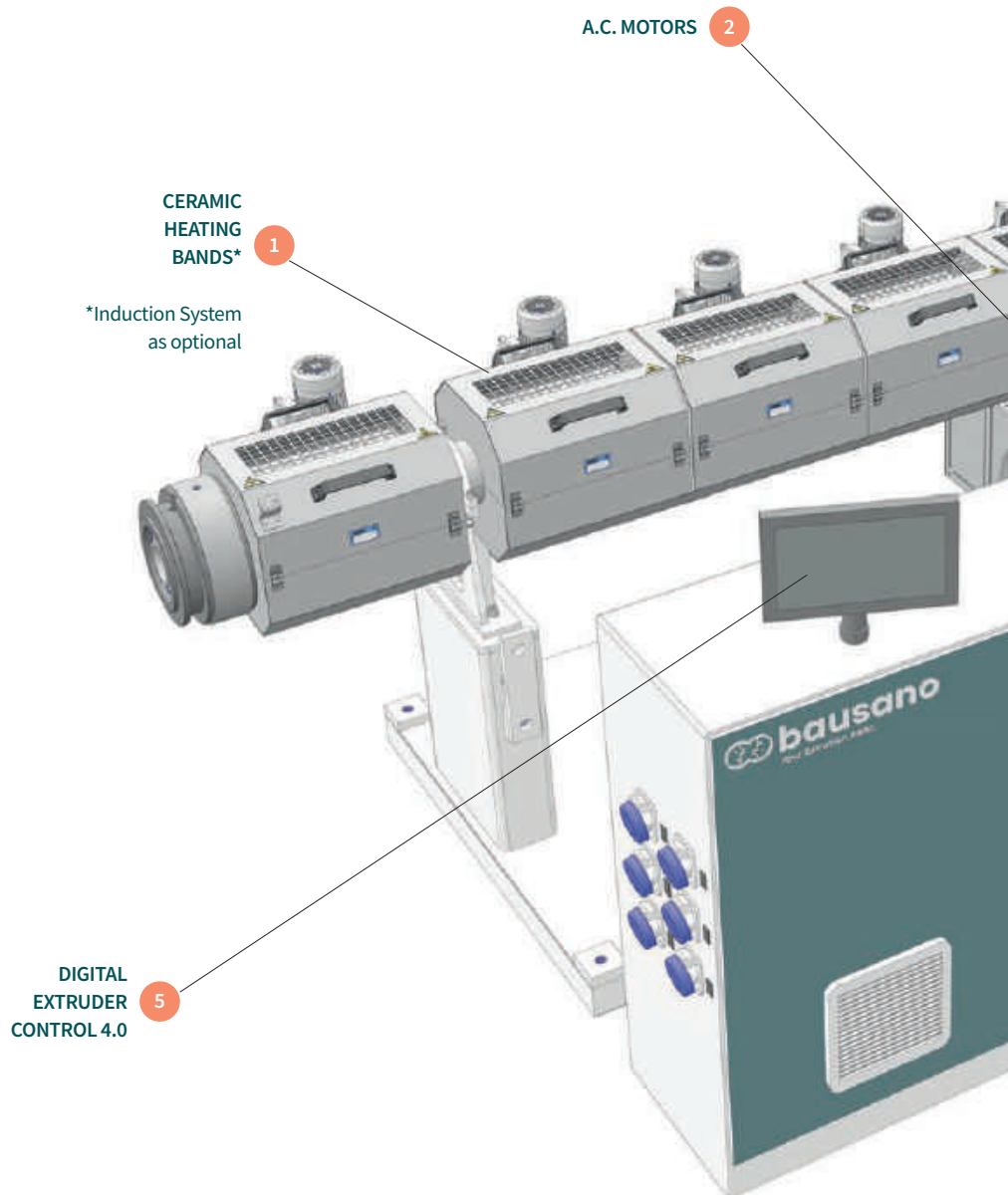

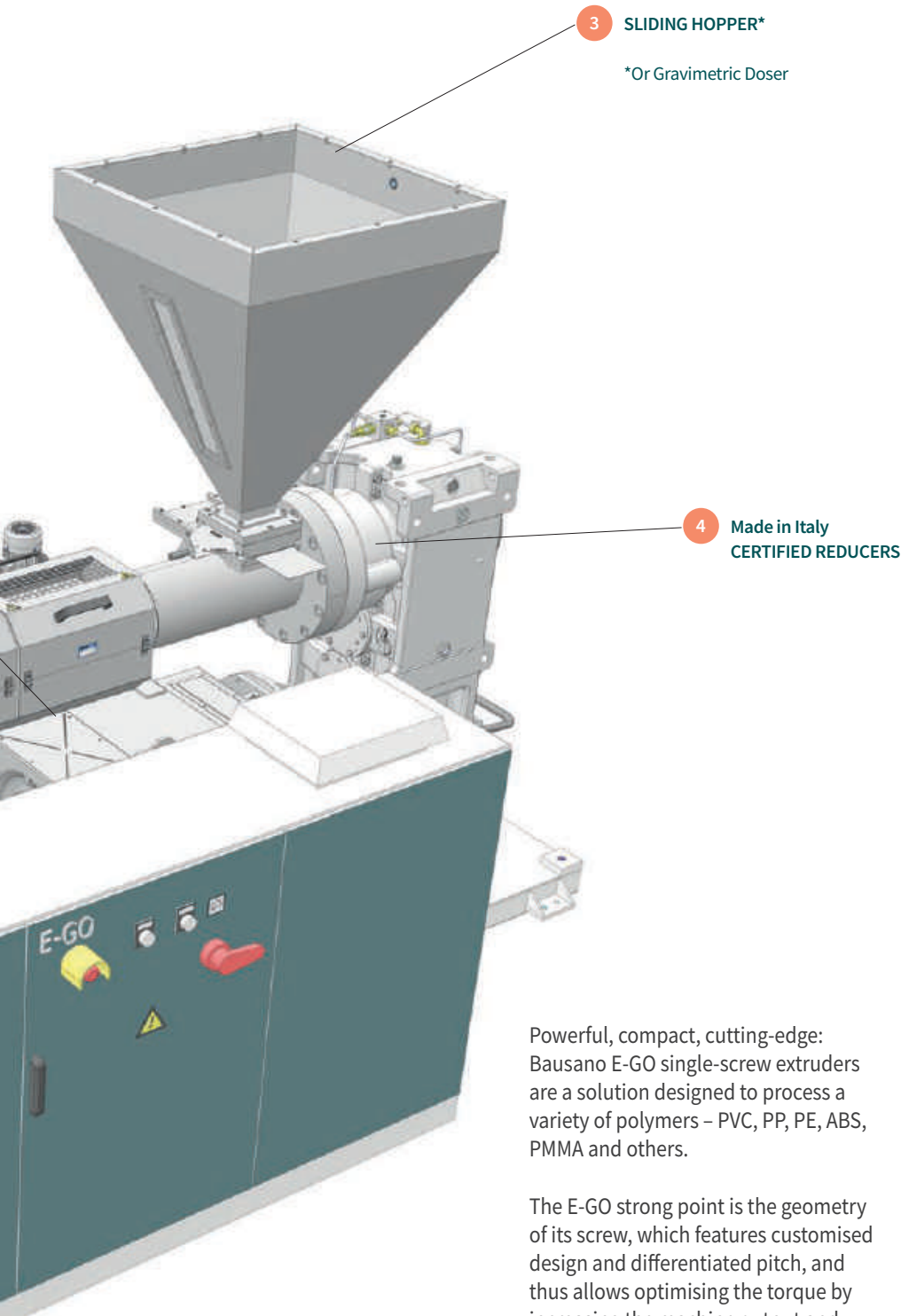

3 **SLIDING HOPPER***

*Or Gravimetric Doser

4 **Made in Italy
CERTIFIED REDUCERS**

Powerful, compact, cutting-edge: Bausano E-GO single-screw extruders are a solution designed to process a variety of polymers – PVC, PP, PE, ABS, PMMA and others.

The E-GO strong point is the geometry of its screw, which features customised design and differentiated pitch, and thus allows optimising the torque by increasing the machine output and making low-temperature processing possible also for materials such as polyolefins.

Energy efficiency is also ensured by the low-input asynchronous motors, while the lower wear reduces the risk of failure and helps decrease overhead costs, by reducing the need for frequent servicing.

Furthermore, thanks to Bausano Digital Extruder Control 4.0, the user interface is completely customisable and allows using the same monitor to control the extruder and the downstream at the same time.

E-GO for profiles

Bausano Single-Screw Extruders

CHARACTERISTICS

- AC motor
- Parallel shaft gear box with helical and ground gears and thrust bearings
- Force-feed lubrication with oil pump and exchanger
- Feeding area with water-cooled external sleeve
- Nitriding steel extruder barrel and screw
- Barrel heating by ceramic heating bands
- Barrel cooling by air fans
- Stainless steel openable barrel cover
- Grooved feeding zone according to the application



This image is for illustrative purposes only.
The machine may be subject to change.

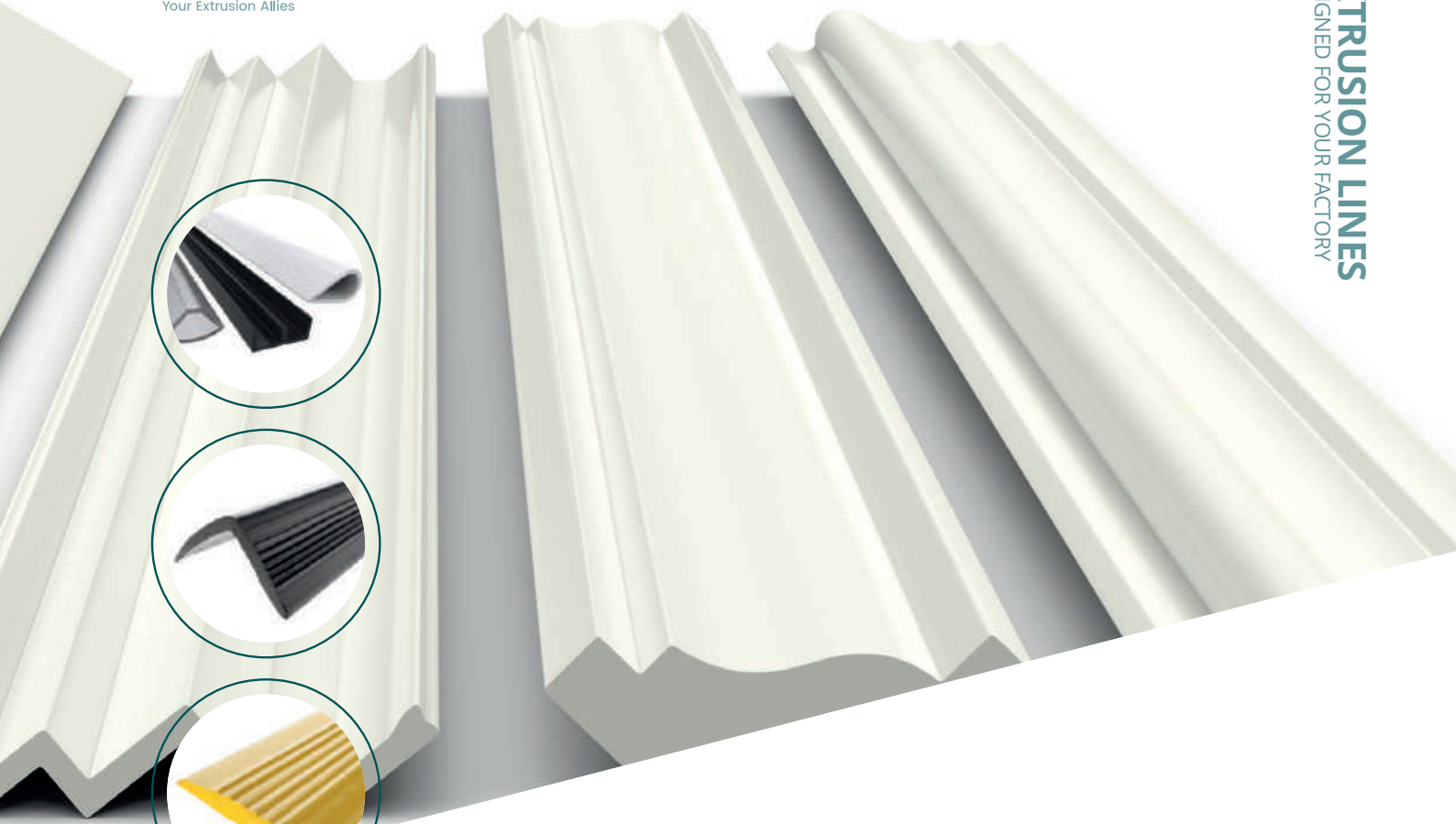

The precision and versatility of our E-GO single-screw extruders allow processing materials such as PVC, PE, HDPE, LDPE, PP-R, WPC, ABS, PC/ABS and many more for the production of technical profiles that are strong, durable and excellent also from an aesthetic point of view.

Roller shutters, window sills but also cableways, edge protections, skirting boards and gutters: an increasing number of construction, furniture and design applications.

To fully capitalize the power of our extruders, a complete range of Bausano accessories is available to build high-performance customised lines.

TECHNICAL DATA

Models		E-GO 45	E-GO 60	E-GO 70	E-GO 75
Screw diameters	(mm)	45	60	70	75
L/D ratios	L/D	25-30	25-30	25-30	25-30
Heating zone	no.	4	4-5	4-5	4-5
Cooling zone	no.	4	4-5	4-5	4-5
Total power	(kW)	25-30	41-50	41-60	57-65

Data may vary according to design specifications.

E-GO for pipes

Bausano Single-Screw Extruders

CHARACTERISTICS

- AC motor
- Three-stage gear box with ground helical gears
- Bimetallic barrel and screws as optional
- Barrel heating by ceramic heating bands
- Barrel cooling by air fans
- Stainless still openable barrel cover
- Grooved feeding zone
- Feeding zone thermoconditioning unit as optional



This image is for illustrative purposes only.
The machine may be subject to change.

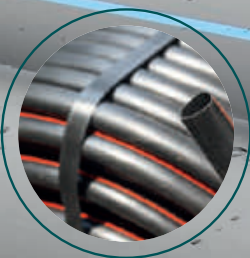

Thanks to the E-GO single-screw technology by Bausano, it is possible to manufacture pipes for a great number of applications in various industries: from construction (water, electrical and gas conduit) to medical and automotive sector.

Single-layer or multilayer pipes, rigid or flexible, with variable diameter, from small to large cross-section; made in PP, PP-R, PE, HDPE, LDPE, PE-X, PE-RT, PMMA, PC, PA and PU.

Thanks to the wide range of Bausano accessories – all customisable – it is possible to build complete extrusion lines, to fit any specific requirements.

TECHNICAL DATA

Models		E-GO 45 LS	E-GO 45 HS	E-GO 45	E-GO 45	E-GO 60	E-GO 60	E-GO 75	E-GO 75	E-GO 90	E-GO 90
Screw diameters	mm	45	45	45	45	60	60	75	75	90	90
L/D ratio	L/D	30	30	37	40	37	40	37	40	37	40
Production = war. Output PE 100	kg/h	100	200	350	520	600	830	850	1250	1200	1900
Production= war. Output PP-HM	kg/h	80	170	300	370	500	600	700	875	1000	1200
Motor Power	kW	22	44	81	100	145	190	214	300	315	450
Required motor torque	Nm	105	211	386	550	692	920	1023	1400	1504	2300
Cooling areas	no.	4	4	5	5	5	5	5	5	5	5
Heating areas	no.	4	4	5	5	5	5	5	5	5	5
Total installed power	kW	36	55	93	140	165	230	239	340	368	500

Data may vary according to design specifications.

E-GO R for recycling

Bausano Single-Screw Extruders



The E-GO R Single Screw Extruder Series is the new recycling and pelletizing Bausano system. It features an optimized L/D ratio, powerful vacuum degassing system and filtering especially suitable for highly contaminated plastic waste such as heavily printed plastic scraps. Pellets obtained from this kind of scrap, after the extrusion process, become granules and can be put directly into the production line for film blowing, pipe extrusion and plastics injection.

EXAMPLE OF PROCESSING MATERIALS:

- PE/PP mixed packaging films
- PE/PP printed film
- PP thermoforming flakes
- PE washed film flakes
- LDPE film waste from agriculture
- LDPE stretch films
- PE/PP/ABS/PS Crushed regrinds

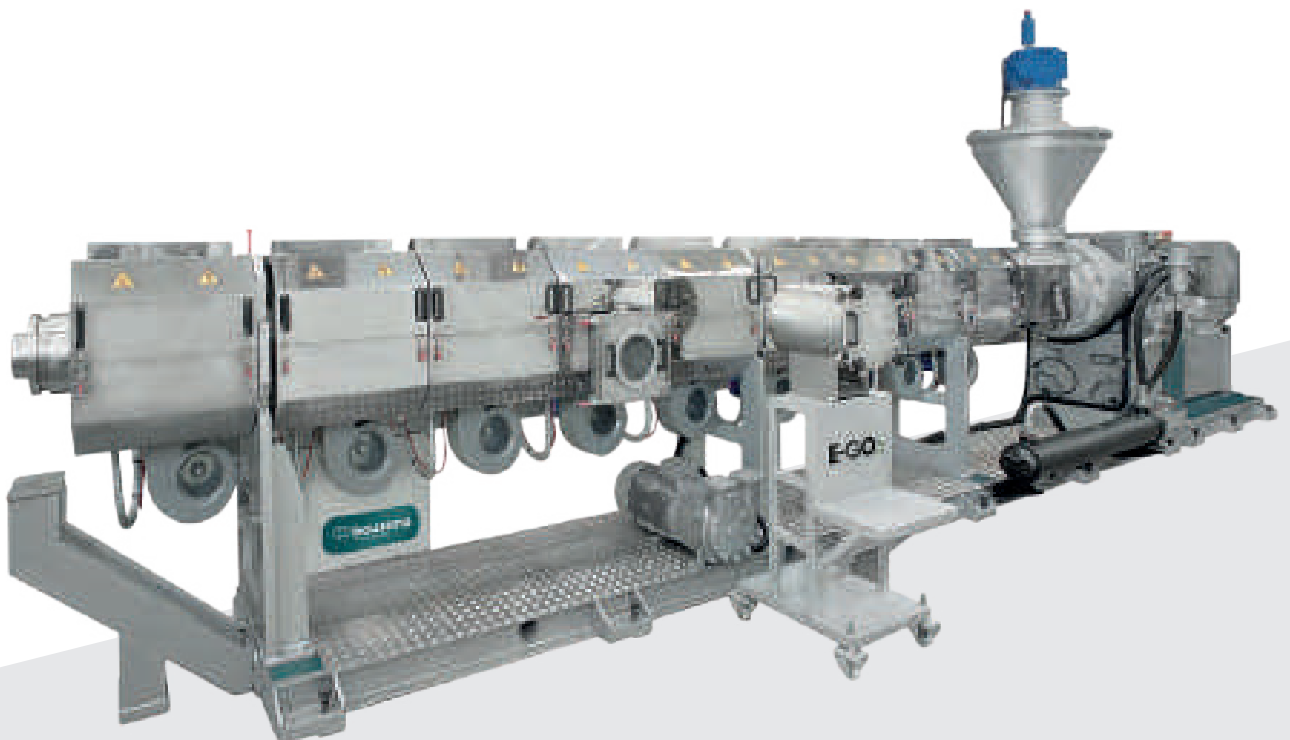

This image is for illustrative purposes only.
The machine may be subject to change.

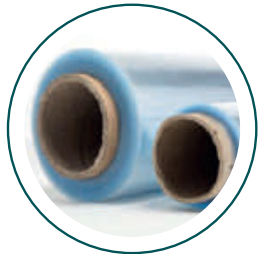
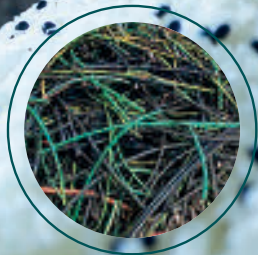

Bausano Single-Screw Extruders are capable of processing a wide range of polymers including:

PE – HDPE – LDPE – LLDPE – PP

Screw Design Technology

+ 75 years of polymer processing and screw design experience supported by Flow Simulation Software ensures polymers are processed with the maximum quality and efficiency.

Polymer Process Control

AC Motor technology with encoder for precision screw speed combined with the intelligent temperature control system ensures complete control over the extrusion operation.

The consistent precision and speed combined with the accurate screw design ensure the highest level of product quality output. This is a specialized single screw extruder to gently melt the pre-compacted material. The plastic scraps will be well melted. With single or double-zone vacuum degassing system, volatiles such as low molecular and moisture will be removed efficiency, especially suitable to heavy printed film and material with water content.

TECHNICAL DATA

Models		E-GO R 75	E-GO R 90	E-GO R 105	E-GO R 125	E-GO R 150	E-GO R 160
Screw diameters	(mm)	75	90	105	125	150	160
L/D ratio	L/D	37	37	37	37	37	37
Capacity	kg/h	180/225	250/300	400/500	550/650	800/950	900/1100
Reduction ratio	no.	l=10	l=10	l=10	l=12,5	l=12,5	l=12,5
Extruder AC motor power	(kW)	66 (1450 RPM)	90 (1450 RPM)	160 (1450 RPM)	210 (1450 RPM)	280 (1450 RPM)	330 (1450 RPM)
Speed Screw	RPM	130	130	130	120	110	110

Data may vary according to design specifications.



BRAZIL



info@bausanodobrasil.com

www.bausanodobrasil.com

INDIA



info@rajoobausano.com

www.rajoobausano.com

info@bausano.com

www.bausano.com