



EasyWOOD

Woodworking is Easy



EasyWOOD

The CAD/CAM software for woodworking

The ideal CAD/CAM for wood and similar materials working industry by numerically controlled machining centres.



**2D Parametric
& 3D**



Cabinet



Nesting



Housing



5 Axis



**Axis
Optimization**



**Simulation and
Collision Detection**



HMI

Software levels

EasyWOOD Nest

Specific for Nesting

EasyWOOD Beginner

The essential

EasyWOOD Standard

3D Project and machining for up to 5 axis CNC

EasyWOOD Premium

Top level: 5 interpolated axis

Additional modules

Automatic CAM processing

It allows to enter machining automatically

3D Simulation and Collision Detection

Perfect 3D model representation of your machine

Nesting True Shape

Optimize your production

BTL Import

BTL Import and manual link of machining

EasyBEAM

BTL Import and automatic generation of beams machining programs

EasyWALL

BTL Import and automatic generation of panels machining programs

Cabinet

Easily create custom cabinets

CAD functions

Below a short description of EasyWOOD CAD main functions:

2D functions

- Lines
- Arcs
- Circles
- Rectangles
- Multiline text
- Polygons
- Nurbs Curves
- Dimensions
- SCL Components
- Import files 2D (DXF, ecc.)

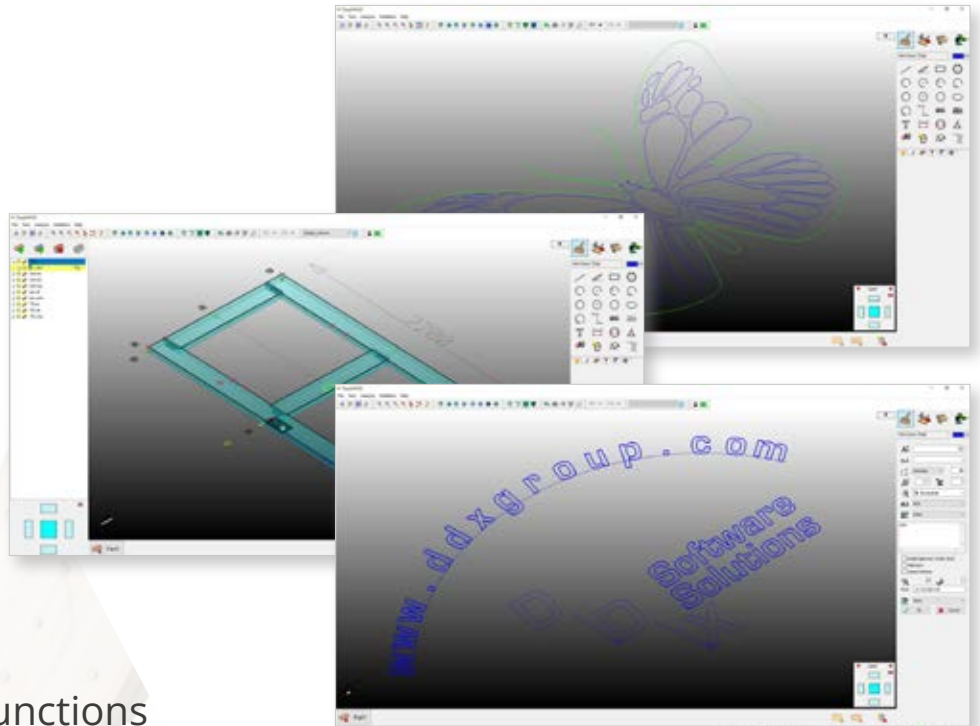

Graphic modification functions

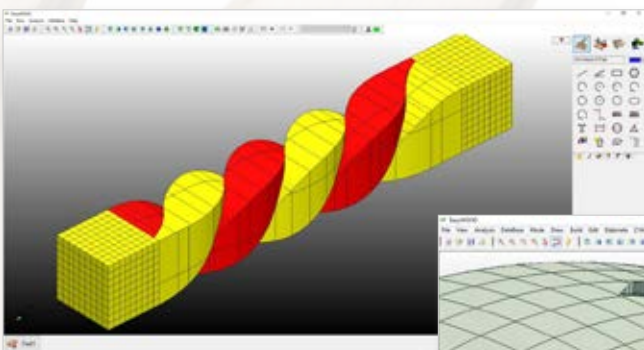

- Rectangle selection
- Move
- Rotate
- Join
- Cut
- Interpolate
- Scale

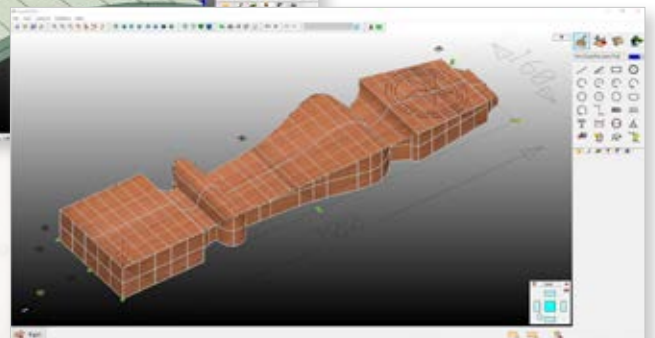
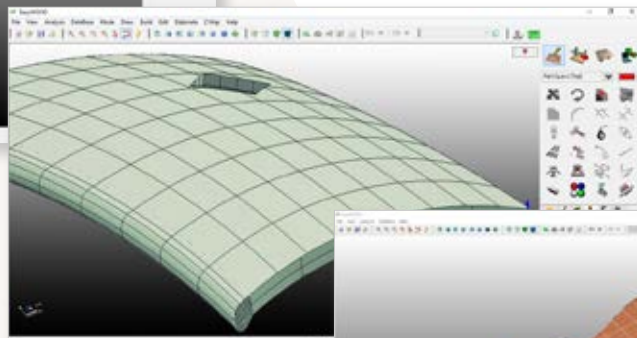

3D functions

- Frames and columns with fixed and variable section/torsion
- Ruled surfaces
- Loft surfaces
- Sweep surfaces
- Gordon surfaces
- Surface modification functions
- Import 3D files (IGES, STL, STEP, SAT, 3DM e SKP)
- Surface offset
- Generation of paths from surfaces
- Junction of two surfaces

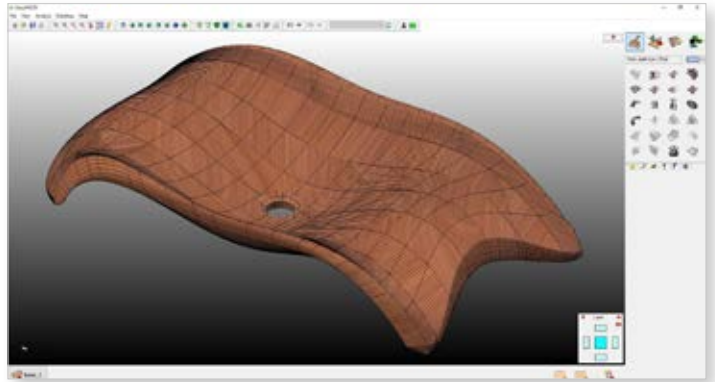

Parametrical engine

- Library of components (vanity tops, kitchen tops, openings, tables, etc.)
- Library of various shapes of panels
- Library of features: included some examples of door hardware, furniture hardware, etc.
- Possibility to add quickly and customized models, panels and features

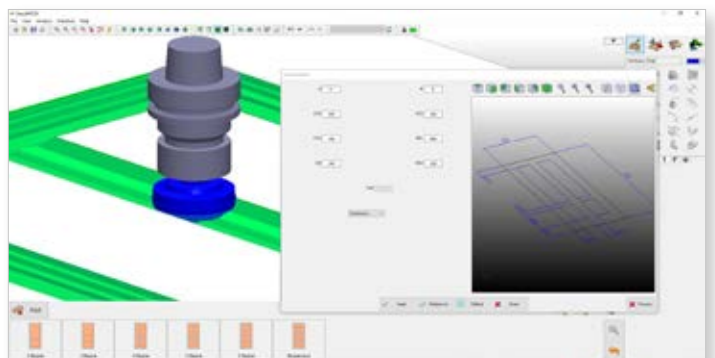
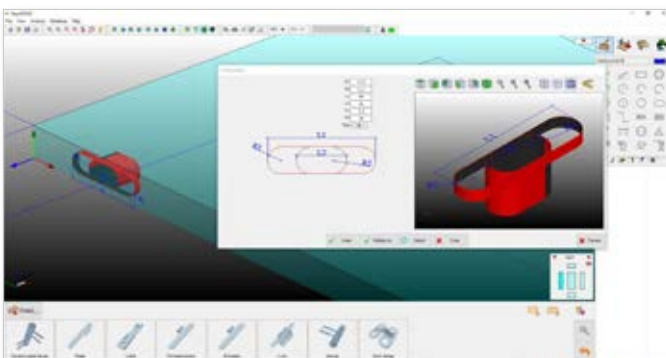
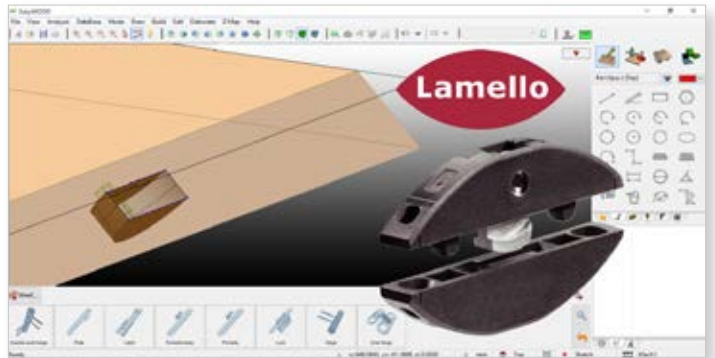
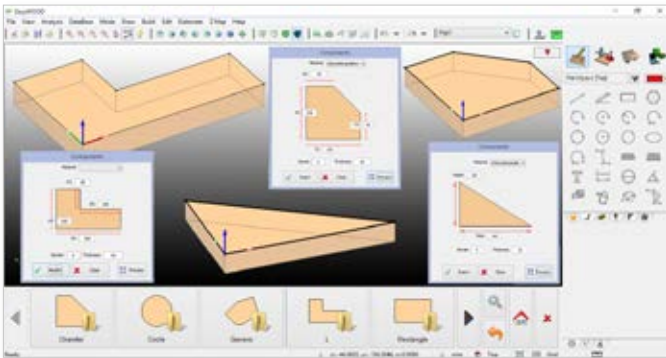

ART module

- Images import
- Images vectorization
- Boolean operations
- Intersections
- Pictures Z Map
- Bas-relief generation

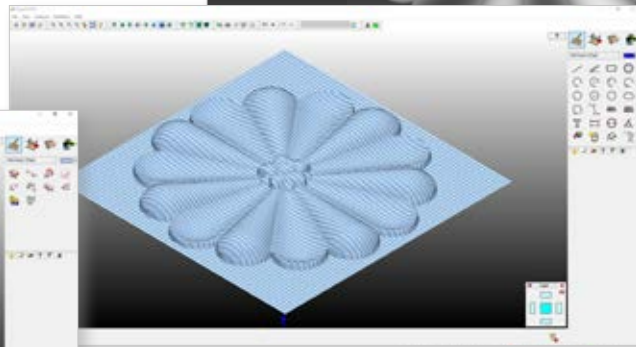
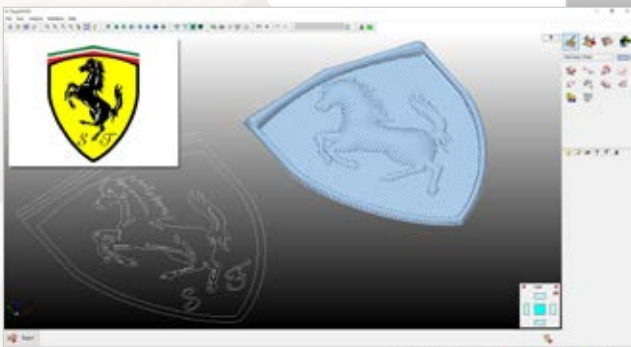
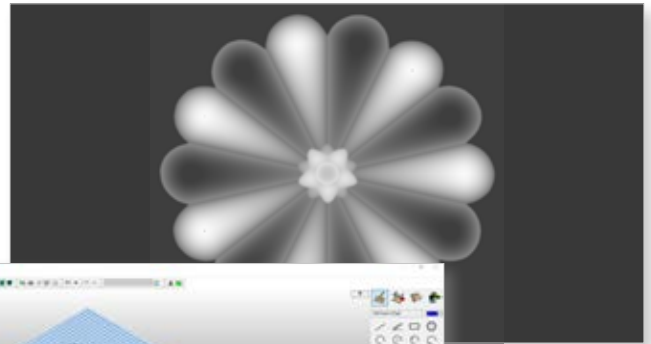

Creation of artistic panels:

- Waves
- Drops
- Voronoi
- Photos engraving

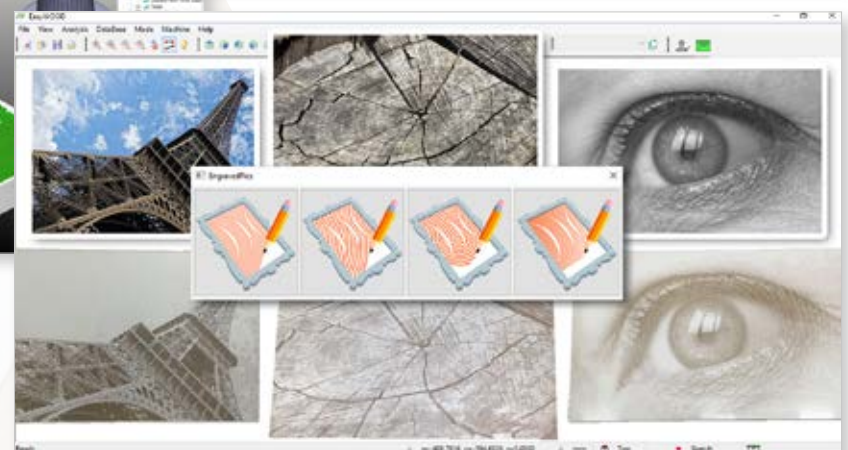
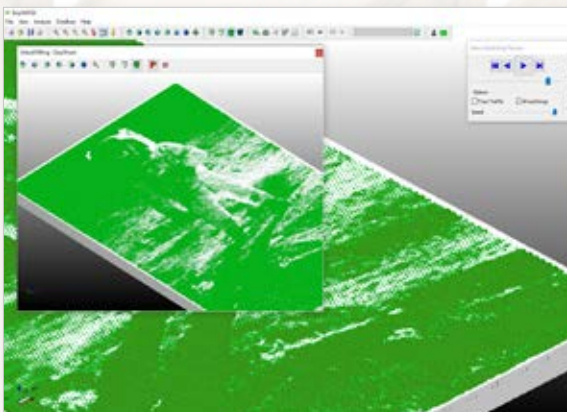
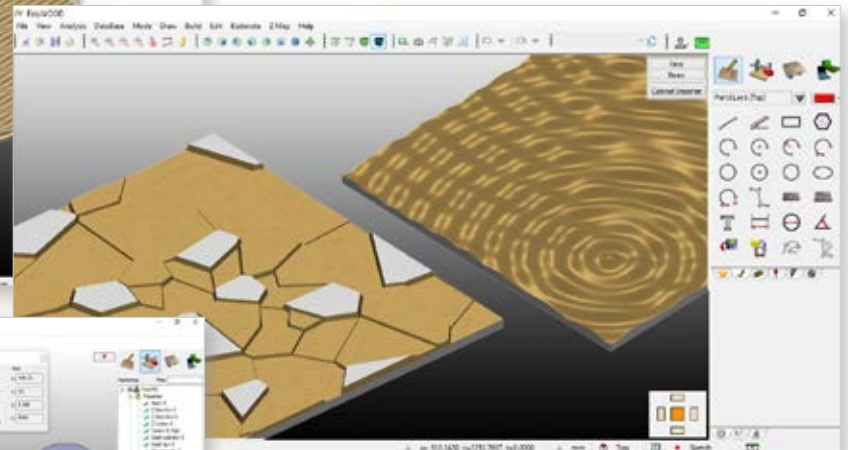
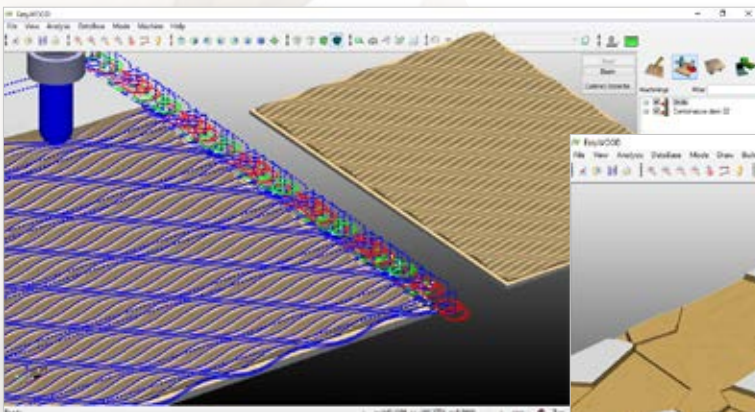

EasyWOOD Nest

Specific for Nesting

Machining

- 3 axis milling
- 3 axis drilling with multiple drilling optimization
- 3 axis profiling
- 3 axis pocketing
- 3 axis contouring with or without tab

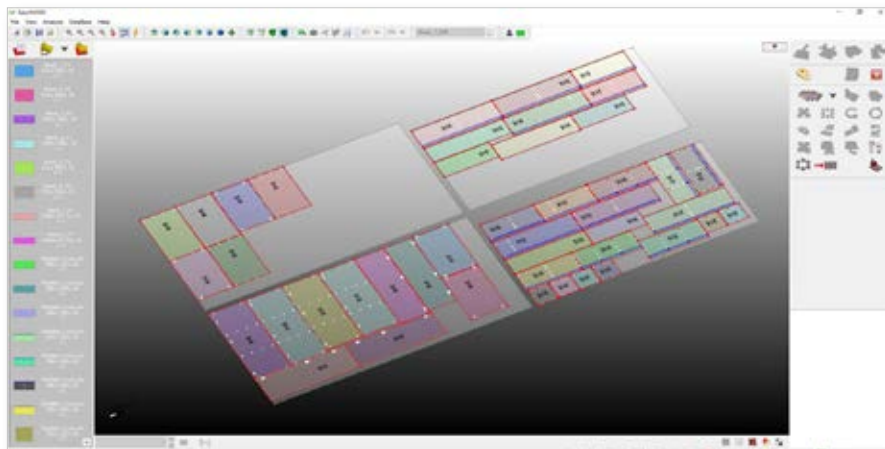
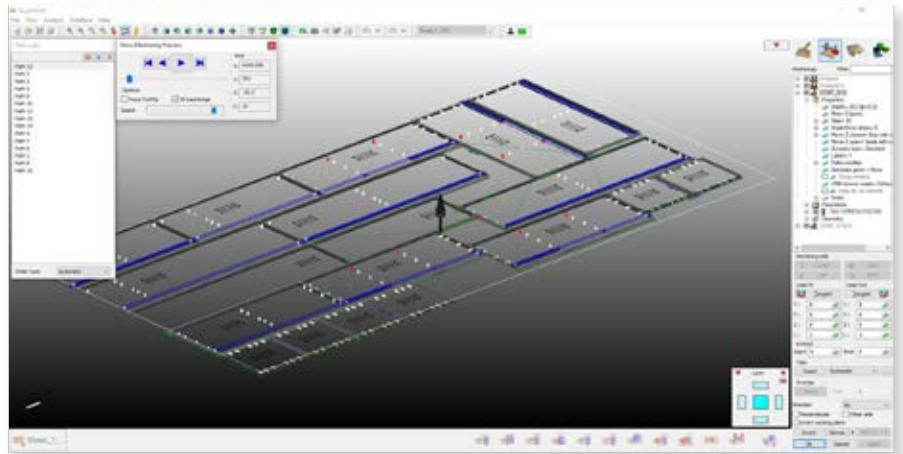

Options

- Multi CNC machines management

Nesting

- Automatic Nesting True Shape
- Possibility to manually modify the optimisation calculated by the software
- Selection of elements from production list (*.csv file)
- Nesting from DXF file
- Generation of label with bar-code
- Panel store management
- Scrap recovery control
- Automatic CAM processing
- Customizable output

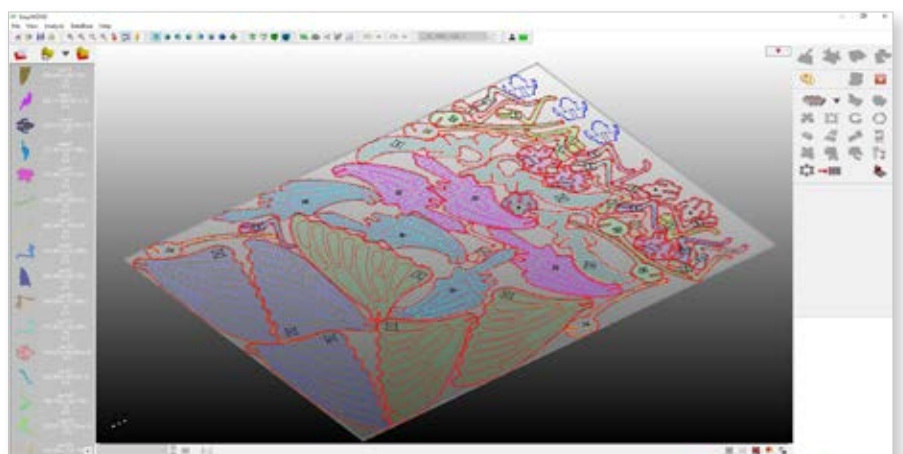

EasyWOOD Beginner

The essential

Available on the following CNC machining centers:

SCM / XILOG ; SCM / XILOG Plus

Morbidelli / XILOG; Morbidelli / XILOG Plus

HOMAG / WoodWoop from version 5

WEEKE / WoodWoop from version 5

Biesse

Masterwood / Masterworks (TLF format)

HOLZ-HER / NC Hops

* Are you a CNC machines manufacturer and you want to be on our list? Please call us!

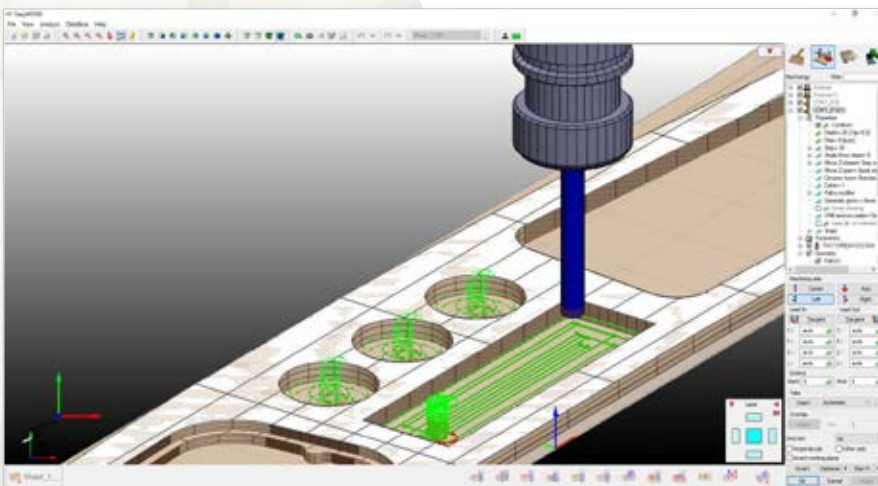

Machining

- 3 axis milling
- 3 axis drilling with multiple drilling optimization
- 3 axis profiling
- 3 axis pocketing
- 3 axis contouring
- 3 axis engraving
- Aggregates management
- Blade cutting
- Virtual milling

Options

- Multi CNC management
- Nesting True Shape
- Automatic CAM processing

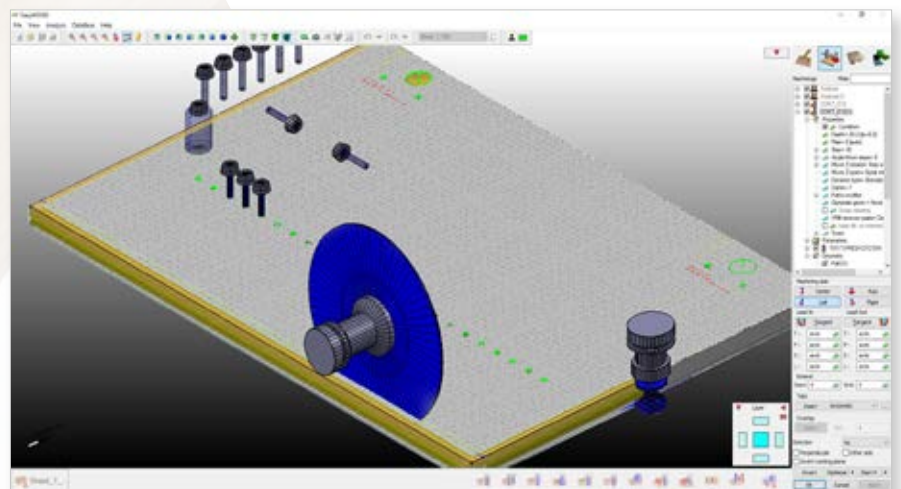

EasyWOOD Standard

3D Project and machining for up to 5 axis CNC

Machining

- 3 axis milling
- 3 axis drilling with multiple drilling optimization
- 3 axis profiling
- 3 axis pocketing
- 3 axis contouring
- 3 axis surface roughing
- 3 axis surface finishing
- 3 axis engraving
- Aggregates management
- Blade cutting
- Virtual milling

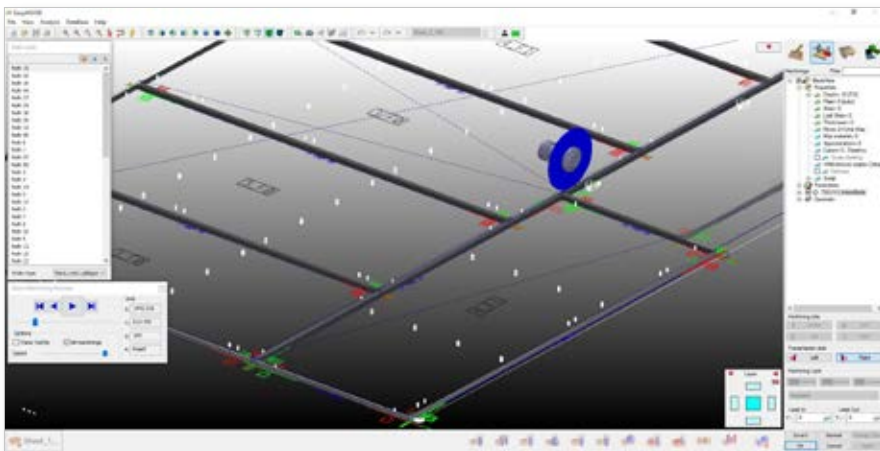
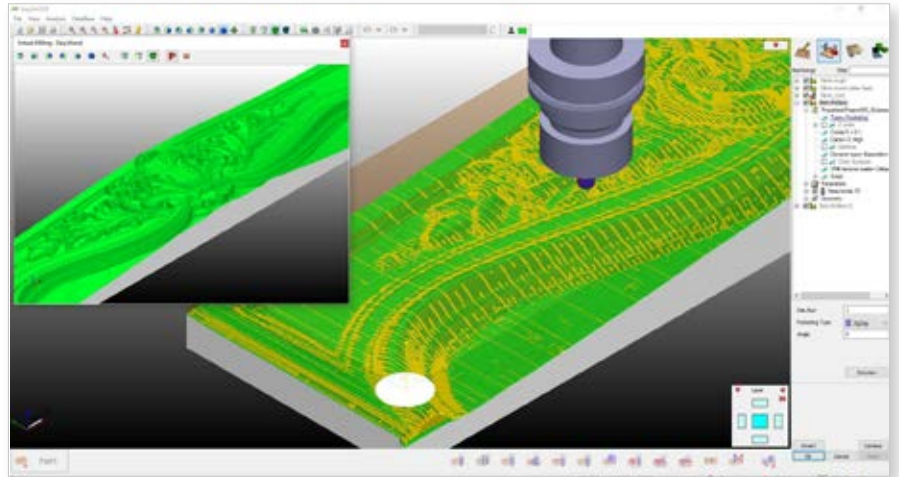

Options

- Multi CNC management
- Nesting True Shape
- Automatic CAM processing
- 3D Collision detection
- 3D Simulation
- Post-processor configuration, customized table

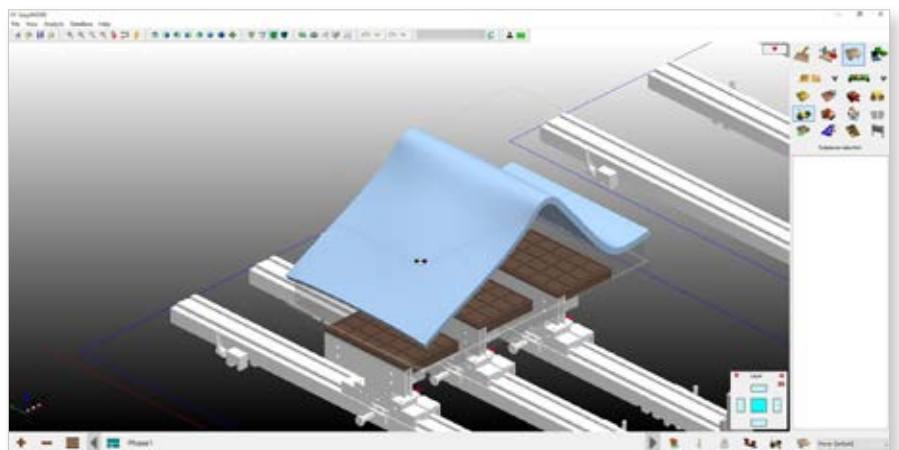

EasyWOOD Premium

Top level: 5 interpolated axis

Machining

- 3 axis milling
- 3 axis drilling with multiple drilling optimization
- 3 axis profiling
- 3 axis pocketing
- 3 axis contouring
- 3 axis surface roughing
- 3 axis surface finishing
- 3 axis engraving
- Aggregates management
- Blade cuts
- 5 axis machining with blade and mill: scallop, flowline, develop, pojection and pocketing
- Virtual milling

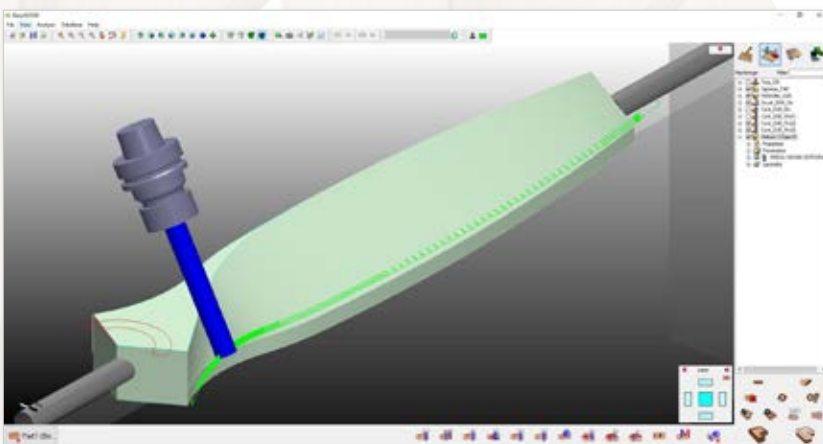
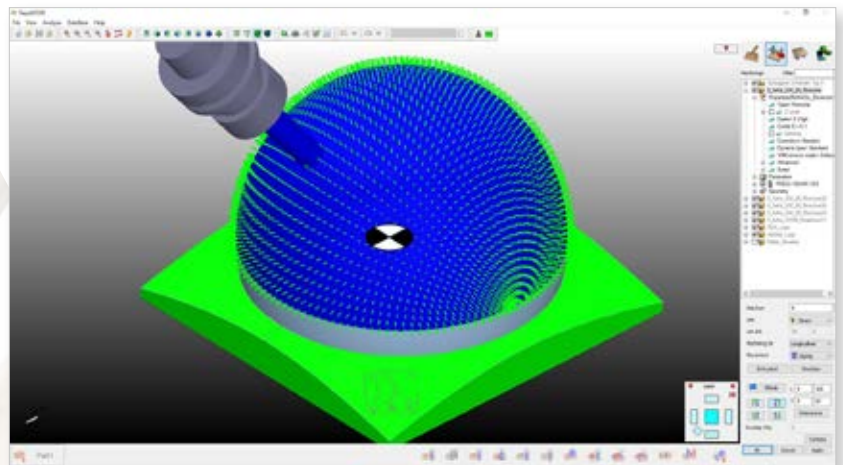
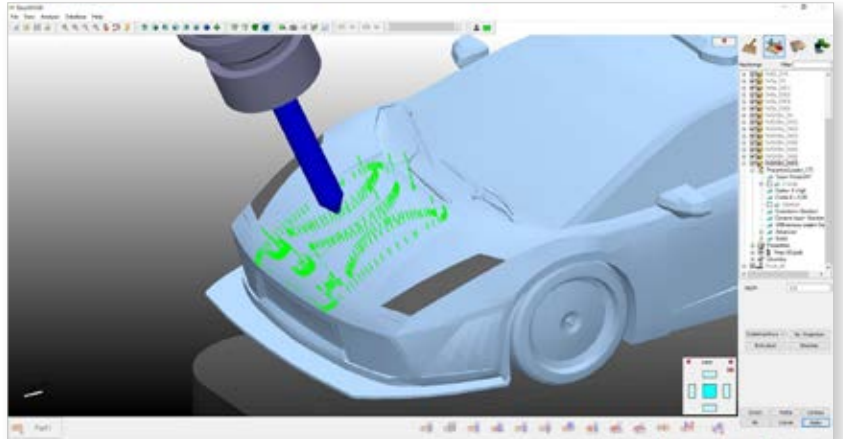

Options

- Multi CNC management
- Nesting True Shape
- Automatic CAM processing
- 3D Collision detection
- 3D Simulation
- Post-processor configuration, customized table
- EasyBEAM
- EasyWALL

Function list

Features	Nest	Beginner	Standard	Premium
	✓	✓	✓	✓
	✓	✓	✓	✓
	✓	✓	✓	✓
		✓	✓	✓
	✓	✓	✓	✓
		✓	✓	✓
	✓	✓	✓	✓

✓: included ○: optional

Function list

Features	Nest	Beginner	Standard	Premium
		✓	✓	✓
		✓	✓	✓
		✓	✓	✓
		✓	✓	✓
	✓	✓	✓	✓
	✓	✓	✓	✓
		✓	✓	✓

✓: included ○: optional

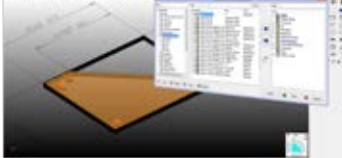
Features	Nest	Beginner	Standard	Premium
		✓	✓	✓
	✓	✓	✓	✓
			✓	✓
				✓
		○	○	○
	✓	✓	✓	✓
	✓	○	○	○
		✓	✓	✓

✓: included ○: optional

Function list

Features	Nest	Beginner	Standard	Premium
 Tool-path graphic simulation	✓	✓	✓	✓
 Graphic 3D simulation of the machining process and machining centre 3D collision detection		○	○	○
 True Shape Nesting	✓	○	○	○
 BTL import version 10.0 or higher				○
 EasyWALL / EasyBEAM for the manufacturing of beams, panels, houses, walls, carpentry. EasyBEAM and EasyWALL imports BTL files version 10.0 or higher				○
 Cabinet	○	○	○	○
	✓	✓	✓	✓
			✓	✓
				✓
	○	○	○	○

✓ : included ○ : optional

Additional modules

Automatic CAM processing

It allows to enter machining automatically making the machining process automatic and reducing production time and costs.

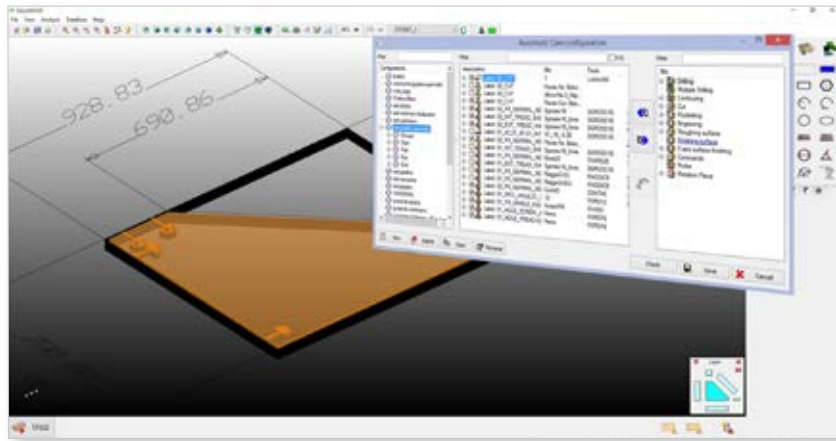

3D Simulation and Collision Detection

Perfect 3D model representation of your machine.

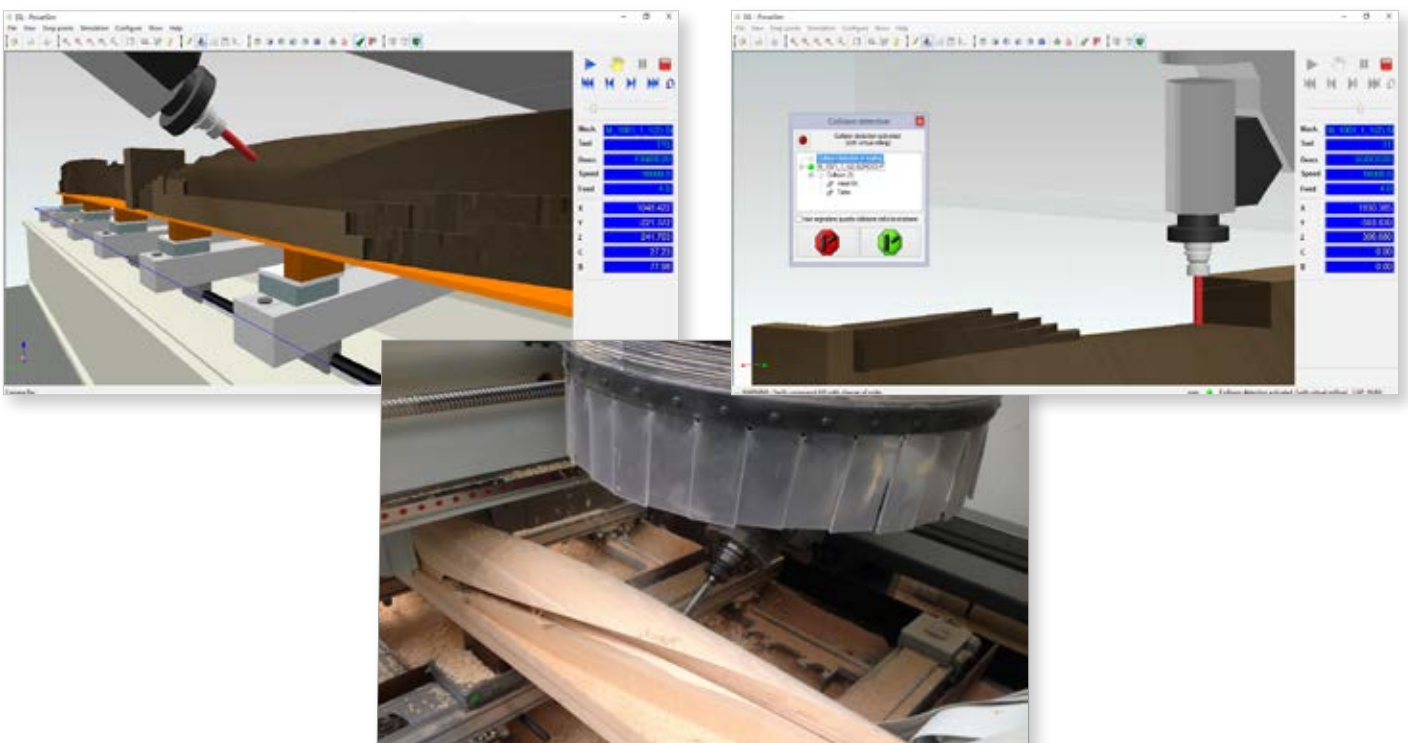

Additional modules

Post-processor and customized table specific for your machine

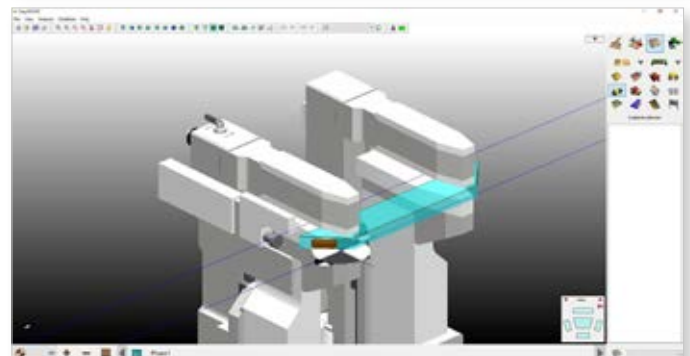
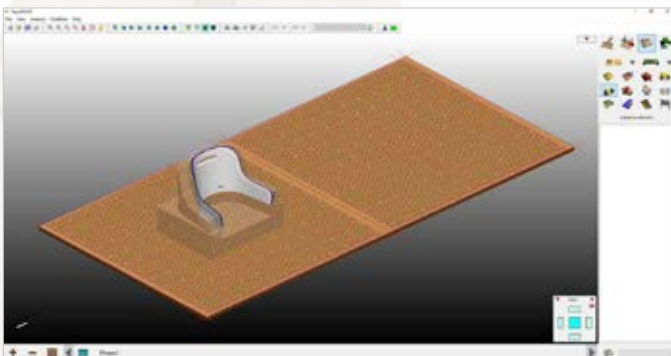
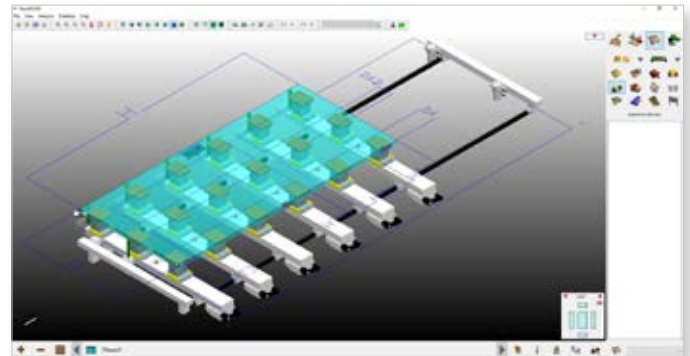
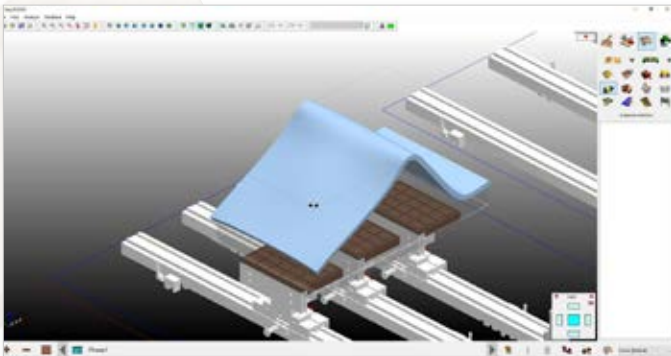

Nesting True Shape

Reduce your waste and optimize your production

- Selection of elements from production list (*.csv file)
- Nesting from DXF file
- Generation of bar-code labels
- Panels store management
- Scrap Recovery control
- Possibility to manually modify the optimization made by the software
- Customizable output

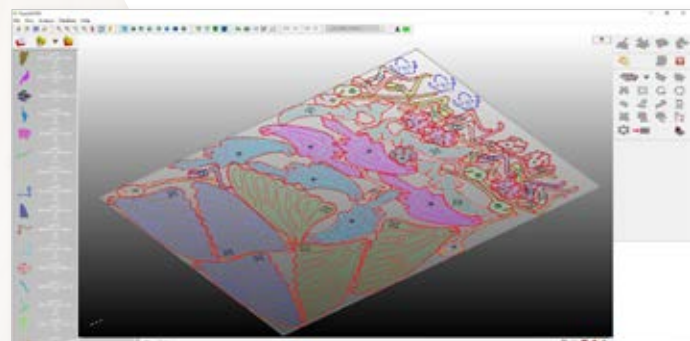
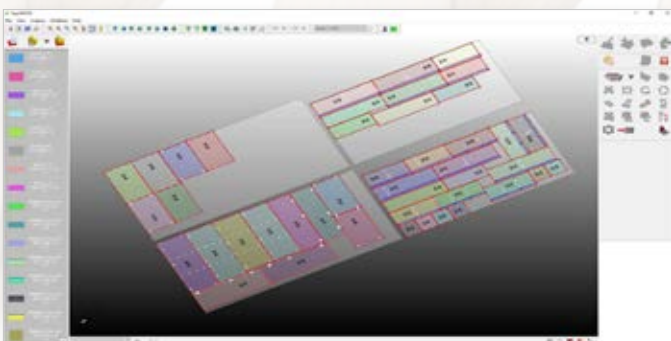

BTL import

Compatible with any CAD software

- BTL file import (ver 10.0 or superior)
- Possibility to manage the EasyWOOD features
- Manual machining application

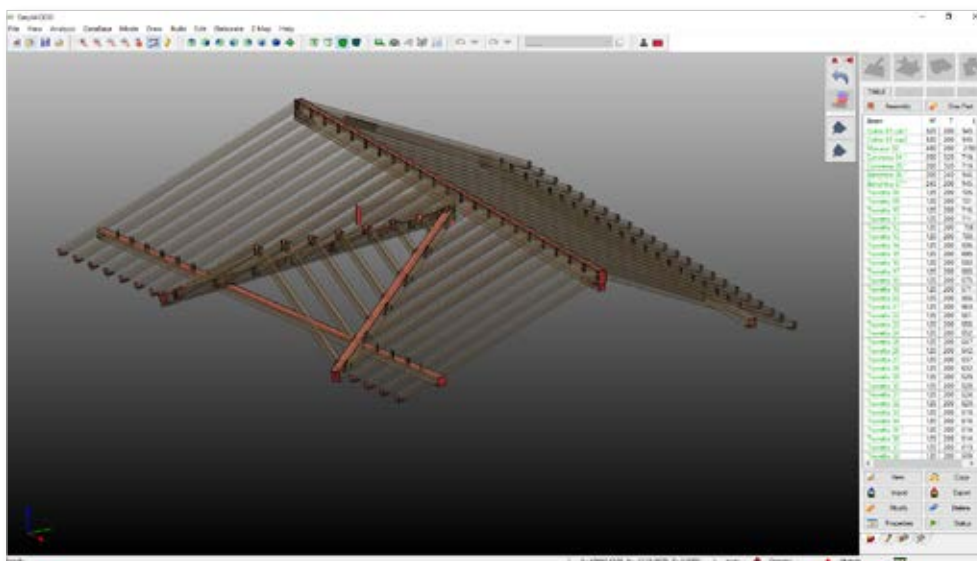
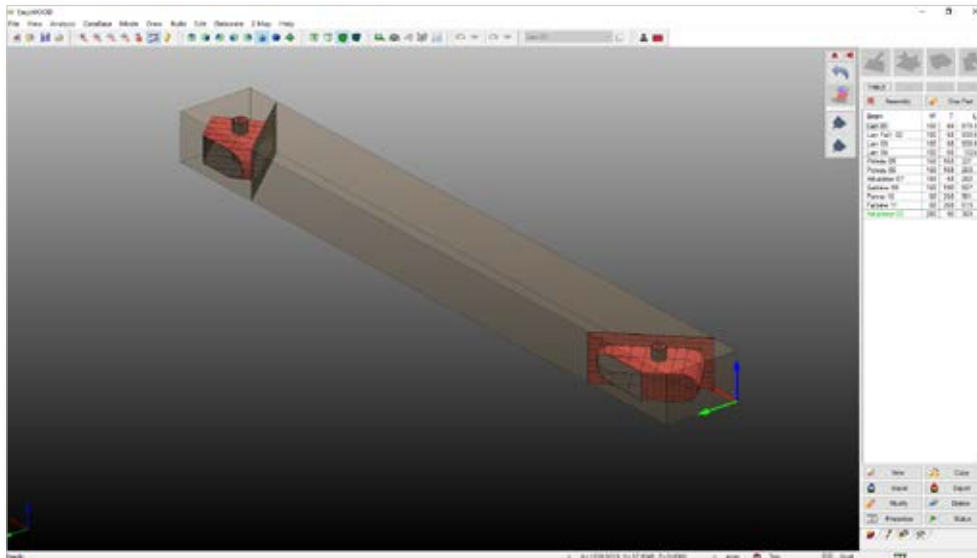

Additional modules

Beam

The additional module specific for beam, roofs and wooden structures production

- BTL import of wooden structures from any CAD software
- Automatic generation of beam machining
- Automatic disposition on the machine table
- 5 axis machining

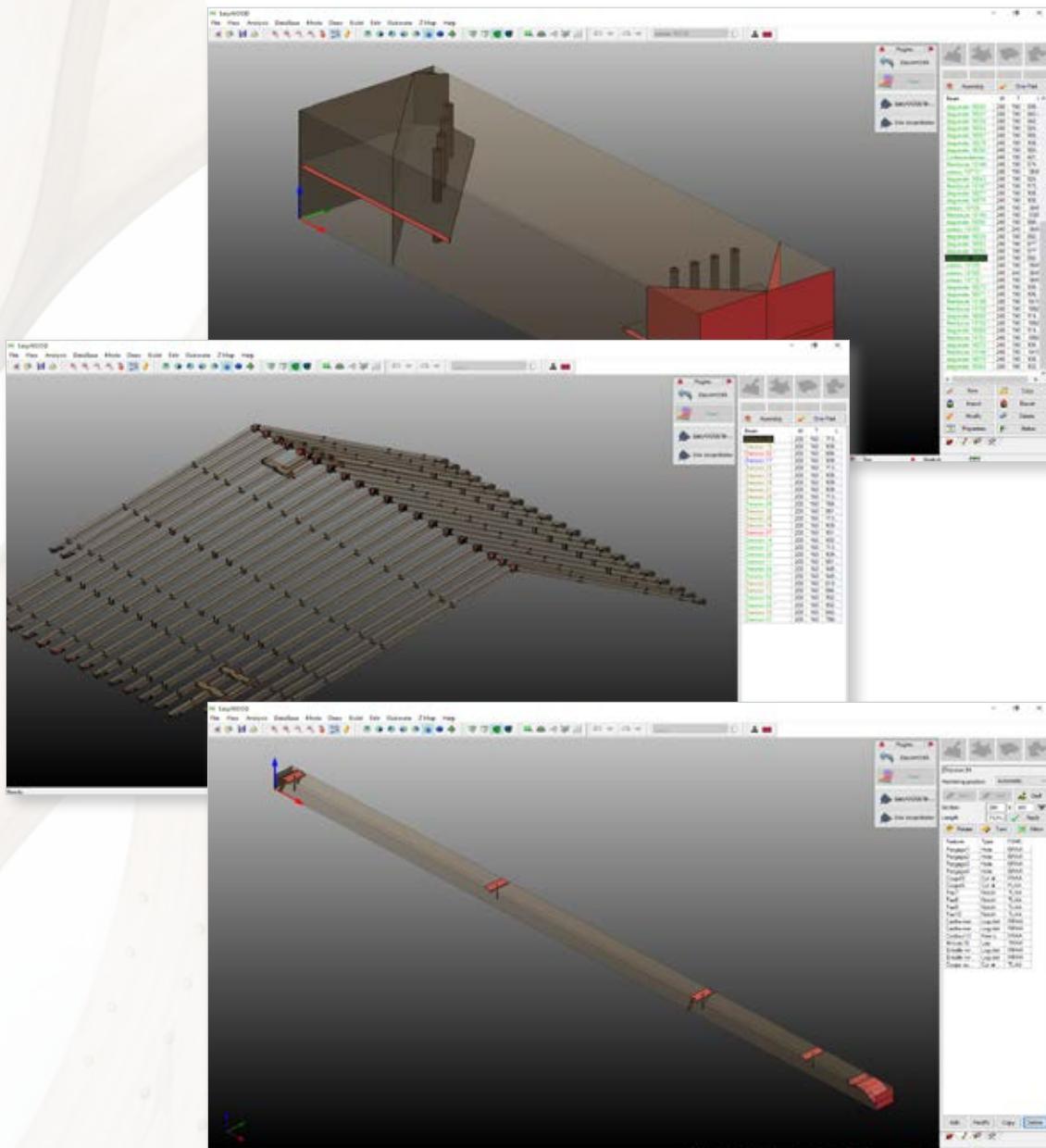

Wall

The additional module specific for wall panels production

- BTL import of structures from any CAD software
- Automatic generation of machining for panels: XLAM, prefabricated, sandwich...
- Nesting True Shape

Options

- Automatic Nesting True Shape

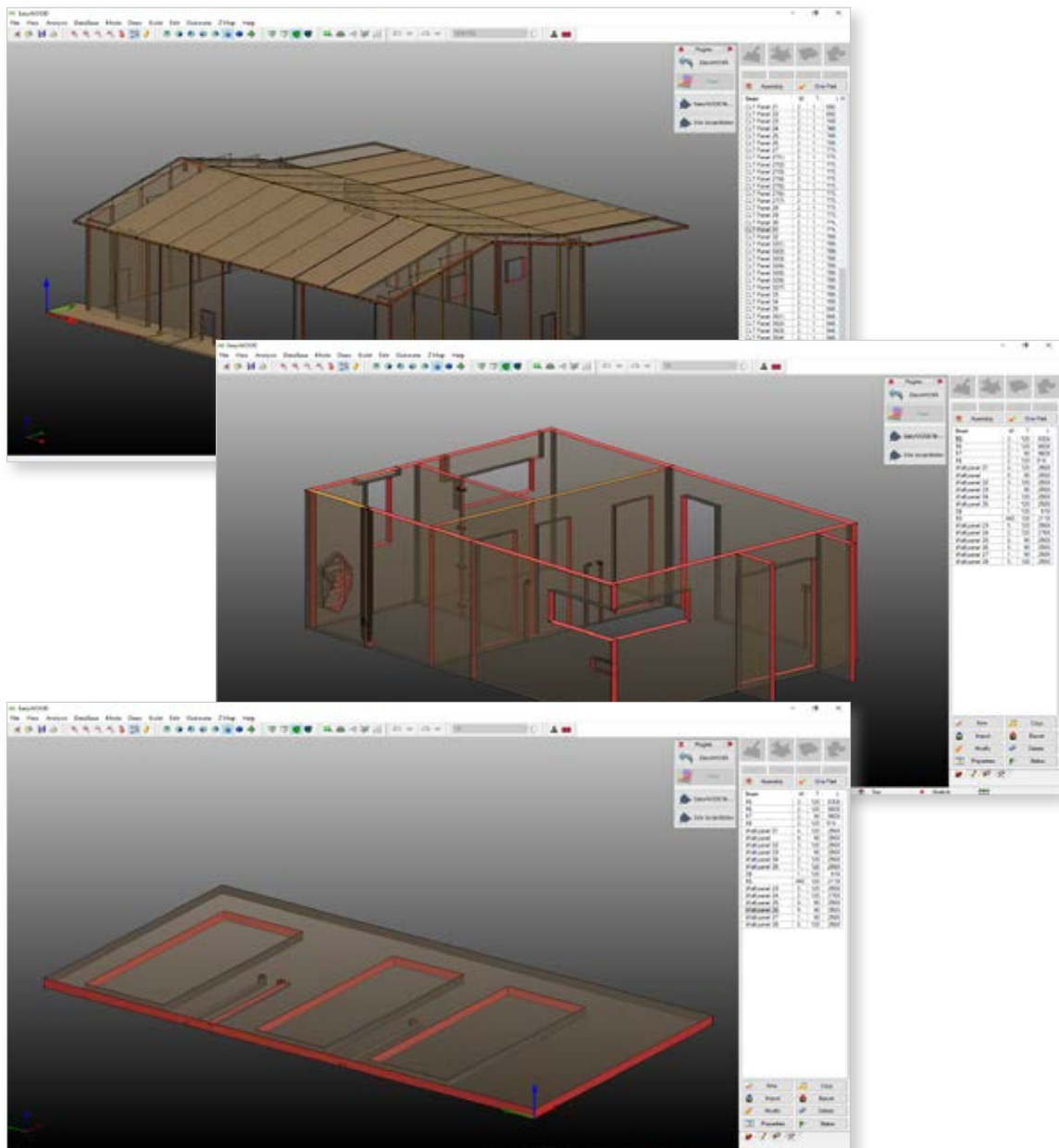

Our Customers

Meiken Lamwood Corp.

Japan www.meikenkogyo.com

Meiken Lamwood Corp., Japan's leading manufacturer of laminated lumber, is an outstanding example of a company that has profited from generating power from leftover wood, bark and other forest residues. The company embarked on its biomass business in 1998, when it invested to installation of a biomass boiler with a generating capacity of 1.950 kw.

Nowadays, Meiken can produce almost all of the power needed at its plant by itself and sell the surplus electricity, reducing its annual costs.

Cross laminated timber (CLT) is an engineered wood panel which has been developed in Europe. Each layer of boards is placed cross-wise to adjacent layers for increased rigidity and strength. Meiken Lamwood Corp is frontrunner company of development CLT with Japanese cedar and spreading CLT technology.



Product: EasyBEAM, EasyWALL, BeamPROD, WallPROD, Nesting, 3 licenses
 CNC machining centers: Uniteam

WeberHaus

Germany www.weberhaus.de

The house of your dreams built with the environment in mind. WeberHaus has created more than 32.000 wooden houses since 1960 and it is one of the most famous company in this sector. Villas, bungalow, energy efficient houses. They focus on quality, energetic efficiency and sustainability. Their motto: Build your house as if it were theirs.



WeberHaus
Die Zukunft leben

Product: EasyWALL, 2 licenses, automatic CAM, nesting
High level of automation
CNC machining center: WEEKE
Project import from BOCAD and automatic production with manual modification

Our Customers

Ebert Schreinerei & CNC-Technik

Germany www.holz-ebert.de

Ebert makes projects with the highest geometric precision.

Milling, drilling, engraving, cutting machining tailored to customer's needs with their modern 5 axis CNC machining centre, which allow them the highest precision in the manufacturing of furniture, front doors, shelves and cabinets like:

- Wood panels
- Solid wood
- Composite materials
- Solid surfaces
- Several plastic materials



Product: EasyWOOD 5 axis, 1 license

CNC machining center: HOLZHER Pro-Master 7125

Automatic design of drawings and transmission to the CNC machining centre with less effort.

LP Charpente & Eden Home

France www.lpcharpente.com

LP Charpente builds three types of prefabricated timber houses:

- Houses with wooden substructure
- Houses with support beams
- Houses with timber cross-laminated walls

LP Charpente combines the latest generation CNC technology to the craftsmanship of finishing and manages the entire production process, from project check to the first assembly of the structure.

LP Charpente produces a wide range of beams, from the small ones for private customers to the bigger ones for the public market.

The company pays attention to environmental sustainability and uses timber from the surrounding area.

Eden Home is a company located in the Haute-Savoie specialized in the building of prefabricated timber houses.

Thanks to the long experience in the field of LP Charpente, Eden Home is able to provide turnkey prefabricated houses.

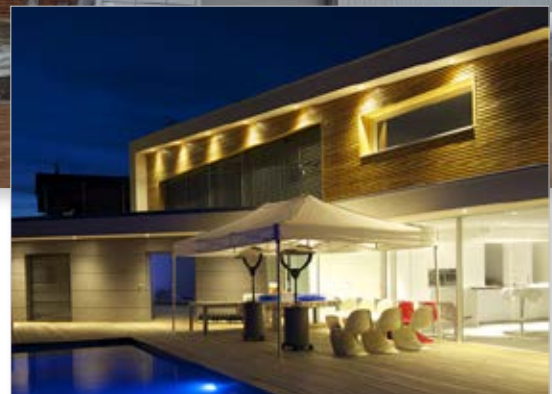

Product: EasyBEAM, EasyWALL, BeamPROD, Nesting, 1 license
 CNC machining center: Uniteam Ultra, Stromab US 27

Our Customers

Giorgetti S.p.A.

Italy www.giorgetti.eu

Giorgetti is one of the industrial excellence of Italian design with collections of chairs/armchairs, tables, bookcases, furniture, beds and accessories designed by some of the most renowned project designers. Collaborations with designers, which began at the end of the 80s, gave Giorgetti the chance to create functional, contemporary pieces with an unmistakable style, integrating the highest artisanship with woodworking tradition, a long-time characteristic of the company, with the use of sophisticated tooling machinery and the most modern product technologies.

The innovative machinery used in producing the Giorgetti collections allows the wood to be shaped while respecting the nature of the wood, as well as guaranteeing an absolute precision in the details.

From design to production, Giorgetti takes pride in the fact that its creative and productive processes are exclusively Italian, so they can use the brand "Made and manufactured in Italy". A choice which allows the entire production process to be checked with respect for the environment as well as guaranteeing the creation of long-lasting furniture.



Product: EasyWOOD 5 axis, 1 license, Multi CNC machining centres control

CNC machining center: CMS Ares 5 axis, CMS 5 axis, CMS 4 axis

Automatic transmission to the CNC machining centre with the manual work of the master craftsmen who make each piece unique.

Service and Assistance

DDX customers can count on a competent and reliable partner.
 Our assistance service can be reached by phone and by remote support.
 Software updates can be downloaded from our website www.ddxgroup.com.

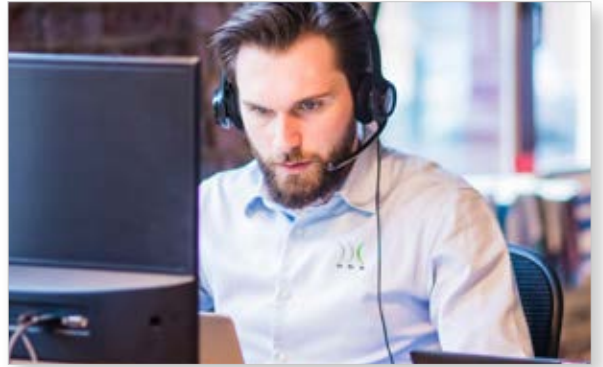

Partner

DDX is partner of the main CNC manufacturers:



All trademarks or registered marks are the property of their respective owners, and are used for informational purposes only and the owner's benefit, without implying a violation of Copyright law.

Other DDX products

Wood field

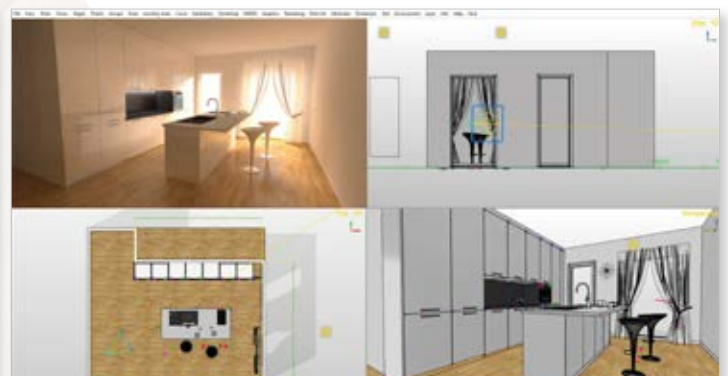
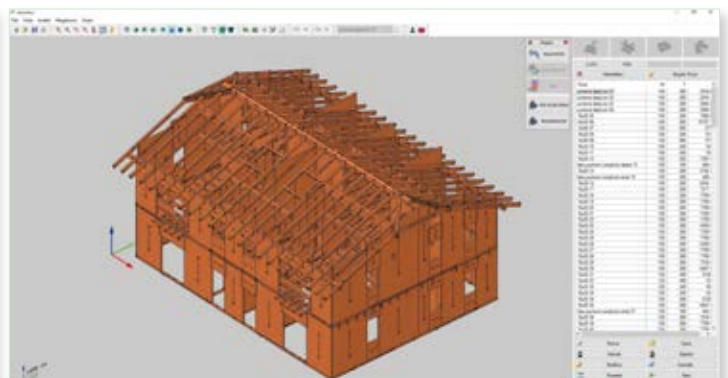
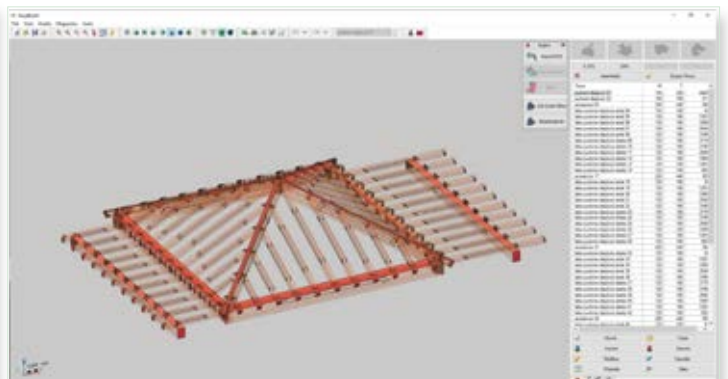

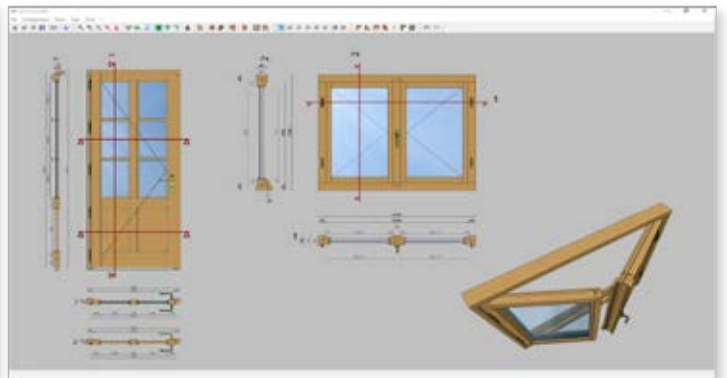

XFactory

Report Marina's garden

JOB	STARTING DAY	STARTING TIME	ENDING DAY	ENDING TIME	DURATION	STATE	LABEL
Sheet_11.67	14/09/2021	9:05	14/09/2021	9:13	8 min.	Sheet_11_167 Model Sheet: 6 Completed printing: 0 Cancelled: 0	Sheet_11.67 - Not printed
Sheet_11.68	14/09/2021	9:15	14/09/2021	9:25	10 min.	Sheet_11_168 Model Sheet: 10 Completed printing: 0 Cancelled: 0	Sheet_11.68 - Not printed
Sheet_11.70	14/09/2021	10:25	14/09/2021	10:37	12 min.	Sheet_11_170 Model Sheet: 10 Completed printing: 0 Cancelled: 0	Sheet_11.70 - Not printed



DDX Software Solutions

Via Donizetti, 109/111
24030 - Brembate di Sopra (BG)
Phone +39 035 621093
ITALY

DDX Deutschland

Oeynhausener Straße 48
32584 - Löhne
Phone +49 573 26871710
GERMANY

DDX Ibérica

Gaspar Bravo de Sobremonte
28341 - Valdemoro (Madrid)
Phone +34 918 955675
SPAIN

DDX France

1 place Saint Martin
79310 - La Boissière-en-Gâtine
Phone +33 (0)5 49955279
FRANCE

DDX Software Solutions | info@ddxgroup.com | www.ddxgroup.com