

ENRX®



# ENRX® Welding Consumables

Product catalogue – Europe, Middle East & Africa

EFD Induction and IPT Technology are now ENRX

# Speeding up the journey

ENRX is a new brand with decades of experience in induction heating, wireless inductive charging and contactless power supply. We speed up the journey to a sustainable world through smart energy transfer within manufacturing and mobility. Need to speed up your journey? We are ready when you are.

If you are in the tube, pipe & profile manufacturing business there is one proven way to reduce costs whilst at the same time meeting ever increasing quality standards: take advantage of our products, services and expertise.

ENRX has for many years been one of the industry's leading suppliers of HF welding consumables. Whether it be a small multi-turn induction coil or giant impeder cluster for 26" diameter API pipe, we have a dedicated solution that fits virtually any application. Aside from impeders and induction coils we also offer a full range of ferrite cores and impeder casings as well as carbide scarfing inserts, tips and cutting rings. As a member of the ENRX Group we are pleased to also offer Canticut I.D. scarfing systems manufactured by our sister ENRX located in the USA.

Our new catalogue covers the full range of standard products we offer, most of which are produced at our specialist manufacturing plant in Poland. If there is something you can't find in this catalogue please do not hesitate to contact us as we offer many non-standard solutions across all product groups.

## CONTENTS

Through-flow impeders .....	4
Return-flow impeders .....	6
Impeder support systems .....	8
Hollow impeders .....	10
Impeder clusters .....	12
Integral mandrel impeders .....	15
Impeder/induction coil selection guide .....	16
Induction welding coils .....	18
Ferrite for high-frequency tube welding .....	20
Impeder casing .....	24
Impeder & Coil cooling systems .....	26
External scarfing .....	27
Internal scarfing .....	30
Canticut ID scarfing system .....	31
Duratrim edge scarfing system .....	32
Pages for notes .....	33

# Through-flow impeders

Through-flow impeders are the most commonly used impeder type. They are also the least expensive. All ENRX impeders use high-performance fluted ferrite to ensure low eddy current losses and to maximize cooling efficiency. Impeders are normally supplied with SAE flare fittings. ISO metric, NPT and BSP pipe fittings and quick connect couplings are available at a small extra cost.

Standard impeders have outer casings that fully enclose and protect the ferrite. Exposed ferrite impeders are used where weld spume or coatings such as aluminium or zinc tend to build up on conventional impeders and shorten their life. Exposed ferrite impeders often permit a larger impeder to be used, since there is no casing at the narrowest part of the tube. These impeders also work well in air or gas-cooled installations. Laminar flow of coolant over the exposed ferrite makes these impeders self-cleaning, and therefore highly resistant to damage from weld spume.

### Casing types

- Epoxy glass

Epoxy glass casing is a high strength, glass fibre-reinforced epoxy resin composite with excellent wear properties, and extended life at high temperatures. It is widely used and is the least expensive type of casing for most impeder sizes. G-11 epoxy glass will withstand temperatures 100 °F (40 °C) higher than the more common G-10 material.

- Ferroglass™

Ferroglass is a high temperature, ferrite-impregnated glass fibre tube made specifically for use in impeders. The extra ferrite in the casing can increase weld speeds by up to 40%. This improved efficiency is most noticeable at small diameters. Ferroglass also has the best wear resistance of all materials normally used in impeders.



- S300 Weld Guard (S300WG)

S300WG is a fluoro polymer coated high temperature epoxy casing we use for our range of small diameter impeders with increased ferrite mass. By increasing ferrite mass we are forced to reduce wall thickness of the impeder casing, to counteract this we apply a special white coating to the casing which is cured using a precise thermal process in a controlled environment. This unique coating gives the impeder a 'low friction' surface reducing the chance of weld spume/spatter sticking to the casing. Weld guard impeders are available from 10mm to 18mm outside diameter in our standard range.

### Cooling requirements

Coolant should be clean, preferably filtered. A pressure of 3 bar (45 PSI) will ensure adequate cooling under most operating conditions. Coolant flow requirements vary widely due to inlet temperature, weld power, frequency and weld area geometry. In high power density situations and at high ambient temperatures, a small chiller for impeder and work coil coolant can greatly improve efficiency. Cooling by air or other gas is not recommended, but can be useful in special situations where the presence of water inside the tube cannot be tolerated. Gasses such as nitrogen have a density that is at least 1,000 times less than water, so coolant volume must be increased accordingly. An impeder cooled using half a gallon (1.9 litres) of water per minute would require a minimum of 15 cubic feet (0.42 m<sup>3</sup>) per minute of nitrogen. The cost of this is prohibitive in most cases.

### Heavy duty impeders

The limiting factor in impeder efficiency is the total amount of magnetic flux that the impeder can support. This varies with temperature & ferrite/ferrite amount. Placing a larger mass of ferrite within an impeder will increase welding efficiency. This becomes important with high powered welders, especially those operating at lower frequencies. ENRX's heavy duty impeders use up to 50% more ferrite than comparable standard impeders & can greatly reduce the amount of power required for a satisfactory weld. Most heavy duty impeders also have thicker outer casing & improved cooling to extend operating life.



THROUGH-FLOW IMPEDER

EXPOSED FERRITE IMPEDER

## Standard through flow impeders

Impeder O.D.(mm)	Coupling Thread	Through Flow Type			Exposed Ferrite Type	
		Ferroglass	Epoxy Glass	S300WG	Ferroglass	Epoxy Glass
6.5mm	#10-32	TFIF-6.5-230	TFIE-6.5-230	n/a	TFIFE-6.5-230	TFIEE-6.5-230
8mm	1/4"-28	TFIF-8-230	TFIE-8-230	n/a	TFIFE-8-230	TFIEE-8-230
9mm	1/4"-28	TFIF-9-230	TFIE-9-230	n/a	TFIFE-9-230	TFIEE-9-230
10mm	1/4"-28	TFIF-10-230	TFIE-10-230	WGTFI-10-230	TFIFE-10-230	TFIEE-10-230
11mm	1/4"-28	TFIF-11-230	TFIE-11-230	WGTFI-11-230	TFIFE-11-230	TFIEE-11-230
12mm	7/16"-20	TFIF-12-230	TFIE-12-230	WGTFI-12-230	TFIFE-12-230	TFIEE-12-230
13mm	7/16"-20	TFIF-13-230	TFIE-13-230	WGTFI-13-230	TFIFE-13-230	TFIEE-13-230
14mm	7/16"-20	TFIF-14-230	TFIE-14-230	WGTFI-14-230	TFIFE-14-230	TFIEE-14-230
15mm	7/16"-20	TFIF-15-230	TFIE-15-230	WGTFI-15-230	TFIFE-15-230	TFIEE-15-230
16mm	7/16"-20	TFIF-16-230	TFIE-16-230	WGTFI-16-230	TFIFE-16-230	TFIEE-16-230
17mm	7/16"-20	TFIF-17-230	TFIE-17-230	WGTFI-17-230	TFIFE-17-230	TFIEE-17-230
18mm	7/16"-20	TFIF-18-230	TFIE-18-230	WGTFI-18-230	TFIFE-18-230	TFIEE-18-230
19mm	7/16"-20	TFIF-19-230	TFIE-19-230	n/a	TFIFE-19-230	TFIEE-19-230
20mm	7/16"-20	TFIF-20-230	TFIE-20-230	n/a	TFIFE-20-230	TFIEE-20-230
21mm	7/16"-20	TFIF-21-230	TFIE-21-230	n/a	TFIFE-21-230	TFIEE-21-230
22mm	7/16"-20	TFIF-22-230	TFIE-22-230	n/a	TFIFE-22-230	TFIEE-22-230
23mm	7/16"-20	TFIF-23-230	TFIE-23-230	n/a	TFIFE-23-230	TFIEE-23-230
24mm	7/16"-20	TFIF-24-230	TFIE-24-230	n/a	TFIFE-24-230	TFIEE-24-230
25mm	7/16"-20	TFIF-25-230	TFIE-25-230	n/a	TFIFE-25-230	TFIEE-25-230
28mm	5/8"-18	TFIF-28-230	TFIE-28-230	n/a	TFIFE-28-230	TFIEE-28-230
31mm	5/8"-18	TFIF-31-230	TFIE-31-230	n/a	TFIFE-31-230	TFIEE-31-230
34mm	3/4"-16	n/a	TFIE-34-230	n/a	n/a	TFIEE-34-230
37mm	3/4"-16	n/a	TFIE-37-230	n/a	n/a	TFIEE-37-230
40mm	3/4"-16	n/a	TFIE-40-230	n/a	n/a	TFIEE-40-230
43mm	3/4"-16	n/a	TFIE-43-230	n/a	n/a	TFIEE-43-230
46mm	3/4"-16	n/a	TFIE-46-230	n/a	n/a	TFIEE-46-230
50mm	7/8"-14	n/a	TFIE-50-230	n/a	n/a	TFIEE-50-230
57mm	7/8"-14	n/a	TFIE-57-230	n/a	n/a	TFIEE-57-230
64mm	7/8"-14	n/a	TFIE-64-230	n/a	n/a	TFIEE-64-230
70mm	7/8"-14	n/a	TFIE-70-230	n/a	n/a	TFIEE-70-230
76mm	1.0" NPT	n/a	TFIE-76-230	n/a	n/a	TFIEE-76-230
89mm	1.0" NPT	n/a	TFIE-89-230	n/a	n/a	TFIEE-89-230
102mm	1.0" NPT	n/a	TFIE-102-230	n/a	n/a	TFIEE-102-230
114mm	1.5" NPT	n/a	TFIE-114-230	n/a	n/a	TFIEE-114-230
127mm	1.5" NPT	n/a	TFIE-127-230	n/a	n/a	TFIEE-127-230
140mm	1.5" NPT	n/a	TFIE-140-230	n/a	n/a	TFIEE-140-230
152mm	1.5" NPT	n/a	TFIE-152-230	n/a	n/a	TFIEE-152-230

A range of imperial to Metric adaptors in both female-female and female-male are available on request.

## Heavy duty impeders

(for High power and/or low frequency applications)

Impeder O.D.(mm)	Coupling Thread	Epoxy Glass		Impeder length	Price multiplication
		Through Flow	Exposed ferrite		
102mm	1.0" NPT	TFIE-102-230HD	TFIEE-102-230HD	230mm	x 1.00
114mm	1.5" NPT	TFIE-114-230HD	TFIEE-114-230HD	330mm	x 1.45
127mm	1.5" NPT	TFIE-127-230HD	TFIEE-127-230HD	430mm	x 1.90
140mm	1.5" NPT	TFIE-140-230HD	TFIEE-140-230HD	530mm	x 2.45
152mm	1.5" NPT	TFIE-152-230HD	TFIEE-152-230HD	630mm	x 2.85
				830mm	x 3.80
				1030mm	x 4.75

Heavy duty impeders contain 30 to 50% more ferrite for improved welding efficiency with high power, lower frequency welders.

Part numbers listed above are for 230 mm long impeders. For other lengths, please use the table on the right.

# Return-flow impeders

ENRX return-flow impeders enable most types of tubing to be produced with a dry inner bore during the high-frequency welding process. Many applications require a dry, clean I.D. such as corrosion prevention for galvanized tubes where 'white rust' can be an issue. Also environmental problems and health & safety headaches can be greatly reduced by removing mill coolant (emulsion) from inside the tube.

Our M-4 return-flow impeders offer the highest performance, working life and serviceability compared to other types and 'home-made' versions. M-4 impeders use standard pipe threads (NPT) and all seals use silicone rubber O-rings, rather than adhesives that may dry out or crack. No fasteners penetrate the outer casings, so the potential for leaks is minimized. The elimination of fasteners also makes these impeders easy to repair, as the internal brass assembly can be easily removed to replace the ferrite or outer cover. Return flow impeders are normally supplied with silicone glass high temperature composite or S300WG fluoro polymer coated casings. For certain applications, either ceramic or fused silica (quartz) maybe a better choice since these materials have

better resistance to heat, molten metal and abrasion, however both are more brittle than composites and will break if subjected to severe mechanical shock.

Since some return-flow impeders may offer more resistance to coolant flow than through-flow types, a higher coolant pressure is recommended. A pressure of at least 4 bar (60 PSI) ensures adequate cooling under most operating conditions. Coolant flow requirements vary widely due to inlet temperature, weld power, frequency and weld area geometry. A 250 micron or smaller coolant filter is recommended when using return-flow impeders to avoid blockages. Since coolant flow can be reduced at lower inlet temperatures, it is beneficial to keep the inlet temperature as low as possible. This may require the use of a heat exchanger or refrigerative cooler when using return-flow impeders. Coolant temperature entering the impeder should not exceed 25°C (75°F). Higher temperatures will result in lower welding efficiency and impeder life. ENRX offers a range of impeder support systems, couplings etc. for all impeders. These are covered on page 8, Impeder support systems.



M-4 IMPEDER (MALE PIPE THREAD)

## Return flow impeders - type m4

Impeder O.D.(mm)	Coupling Thread	S300WG	Thin wall version*
8mm	1/4" - 28	RFI8-230S	n/a
9mm	1/4" - 28	RFI9-230S	n/a
10mm	1/4" - 28	RFI10-230S	RFITW-10-230-S300WG
11mm	1/8" NPT	RFI11-230S	RFITW-11-230-S300WG
12mm	1/8" NPT	RFI12-230S	RFITW-12-230-S300WG
13mm	1/8" NPT	RFI13-230S	RFITW-13-230-S300WG
14mm	1/8" NPT	RFI14-230S	RFITW-14-230-S300WG
15mm	1/8" NPT	RFI15-230S	n/a
16mm	1/4" NPT	RFI16-230S	RFITW-16-230-S300WG
17mm	1/4" NPT	RFI17-230S	n/a
18mm	1/4" NPT	RFI18-230S	n/a
19mm	1/4" NPT	RFI19-230S	RFITW-19-230-S300WG
20mm	1/4" NPT	RFI20-230S	n/a
21mm	1/4" NPT	RFI21-230S	RFITW-21-230-S300WG
22mm	1/4" NPT	RFI22-230S	RFITW-22-230-S300WG
23mm	3/8" NPT	RFI23-230S	n/a
24mm	3/8" NPT	RFI24-230S	n/a
25mm	3/8" NPT	RFI25-230S	n/a
28mm	3/8" NPT	RFI28-230S	n/a
31mm	3/8" NPT	RFI31-230S	n/a
34mm	1/2" NPT	RFI34-230S	n/a
37mm	1/2" NPT	RFI37-230S	n/a
40mm	1/2" NPT	RFI40-230S	n/a
43mm	3/4" NPT	RFI43-230S	n/a
46mm	3/4" NPT	RFI46-230S	n/a
50mm	3/4" NPT	RFI50-230S	n/a
57mm	1" NPT	RFI57-230S	n/a
64mm	1" NPT	RFI64-230S	n/a
70mm	1" NPT	RFI70-230S	n/a
76mm	1" NPT	RFI76-230S	n/a
89mm	1" NPT	RFI89-230S	n/a
102mm	1" NPT	RFI102-230S	n/a
114mm	1.5" NPT	RFI114-230S	n/a
127mm	1.5" NPT	RFI127-230S	n/a
140mm	1.5" NPT	RFI140-230S	n/a
152mm	1.5" NPT	RFI152-230S	n/a

\* Thin wall version has larger ferrite core for high efficiency/welding speed where required.

## Heavy duty impeders

(for High power and/or low frequency applications)

Impeder O.D.(mm)	Coupling Thread	Heavy duty R/F
102mm	1.0" NPT	RFI102-230HD
114mm	1.5" NPT	RFI114-230HD
127mm	1.5" NPT	RFI127-230HD
140mm	1.5" NPT	RFI140-230HD
152mm	1.5" NPT	RFI152-230HD

Heavy duty impeders contain 30 to 50% more ferrite for improved welding efficiency with high power, lower frequency welders. Part numbers listed above are for 230 mm long impeders. For other lengths, please use the table below.

Impeder length	Price multiplication
230mm	x 1.00
330mm	x 1.45
430mm	x 1.90
530mm	x 2.45
630mm	x 2.85
830mm	x 3.80
1030mm	x 4.75

# Impeder support systems

For maximum performance and life, all impeders should be supported to ensure they are properly positioned and do not drag on the inside of the tube. ENRX makes impeder holders to suit all types of tube mills. Interchangeable adapters allow through-flow and return-flow types to be used with the same basic support system.

The three-way adjustable mounting bracket and clamping system provides a simple and reliable means of adjusting impeder position. Holders are available for impeders from 6 mm (1/4 inch) to 150 mm (6 inch) in seven overlapping ranges.

An optional second support prevents long assemblies from drooping under their own weight and accurately maintains the impeder's vertical position inside the tube.

In addition to ENRX's precision line of impeder support systems, we can also supply a variety of return-flow couplings for temporary or short term use.

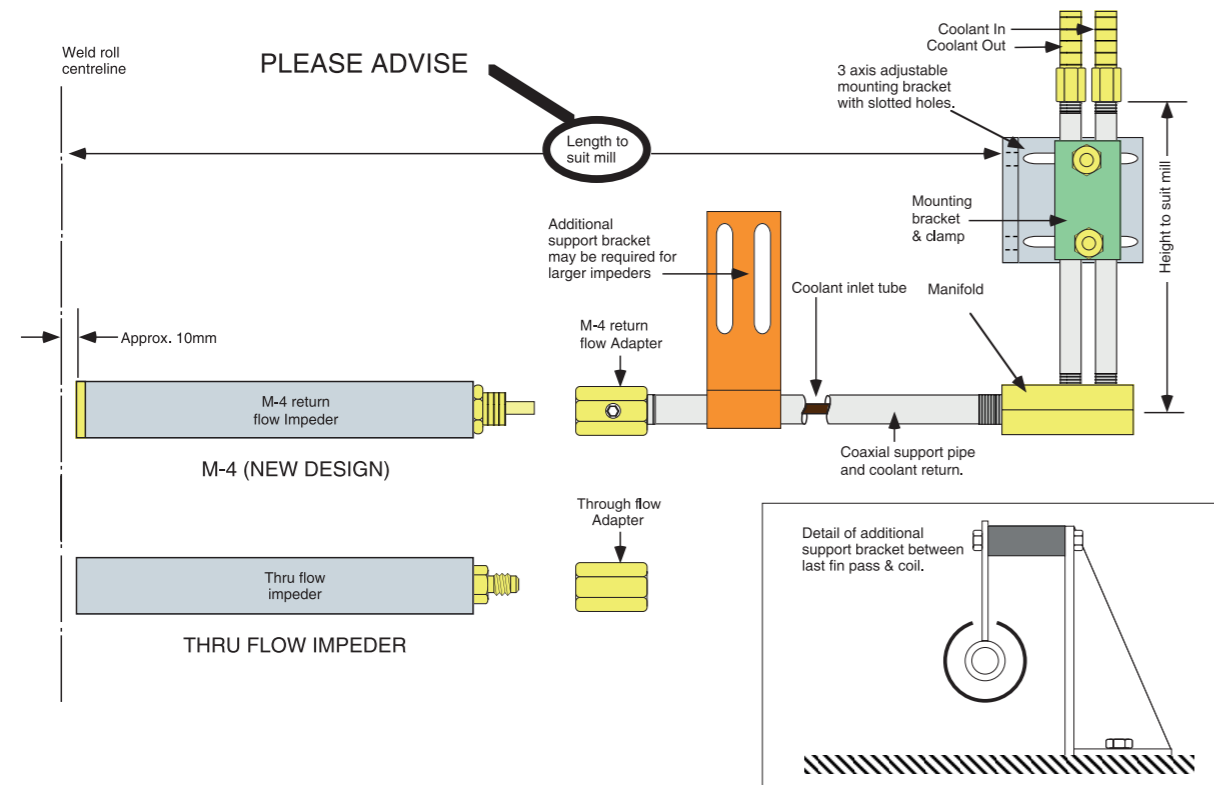

## Impeder support system

Support tube nominal pipe size/Return flow coupling size	1/16"	1/8"	1/4"	3/8"	1/2"	3/4"	1"
OD of outer tube	7.95mm	10.3mm	13.7mm	17.1mm	21.3mm	26.6mm	33.4mm
Mounting Bracket & clamp	RF-MBC-1/16	RF-MBC-1/8	RF-MBC-1/4	RF-MBC-3/8	RF-MBC-1/2	RF-MBC-3/4	RF-MBC-1
Manifold	RF-MAN-1/16	RF-MAN-1/8	RF-MAN-1/4	RF-MAN-3/8	RF-MAN-1/2	RF-MAN-3/4	RF-MAN-1
Inlet/outlet tubes (2 req'd)	RF-TUBE-SMALL	RF-TUBE-SMALL	RF-TUBE-SMALL	RF-TUBE-SMALL	RF-TUBE-LRGE	RF-TUBE-LRGE	RF-TUBE-LRGE
Hanger Blade support* Adaptor	RF-SH-1/16	RF-SH-1/8	RF-SH-1/4	RF-SH-3/8	RF-SH-1/2	RF-SH-3/4	RF-SH-1
Support tube - through flow	BAR-TF-1/16	BAR-TF-1/8	BAR-TF-1/4	BAR-TF-3/8	BAR-TF-1/2	BAR-TF-3/4	BAR-TF-1
Support tube - return flow	BAR-COAX-1/16	BAR-COAX-1/8	BAR-COAX-1/4	BAR-COAX-3/8	BAR-COAX-1/2	BAR-COAX-3/4	BAR-COAX-1
Complete system	RFSS-1/16	RFSS-1/8	RFSS-1/4	RFSS-3/8	RFSS-1/2	RFSS-3/4	RFSS-1

\* hanger blade support is required for tube lengths >1m

## Impeder couplings

return flow M4

Coupler	Impeder range	standard	with hanger blade
1/4"-28	8-10mm	M4-COUP-1/4-28	M4-COUPH-1/4-28
1/8" NPT	11-15mm	M4-COUP-1/8	M4-COUPH-1/8
1/4" NPT	16-22mm	M4-COUP-1/4	M4-COUPH-1/4
3/8" NPT	23-31mm	M4-COUP-3/8	M4-COUPH-3/8
1/2" NPT	34-40mm	M4-COUP-1/2	M4-COUPH-1/2
3/4" NPT	43-50mm	M4-COUP-3/4	M4-COUPH-3/4
1" NPT	50-76mm	M4-COUP-1	M4-COUPH-1



## Heavy duty hanger blade assemblies

Hanger Blade assembly	Support tube nominal size	
	1/2"	1"
	RFSS-HD-0.5	RFSS-HD-1

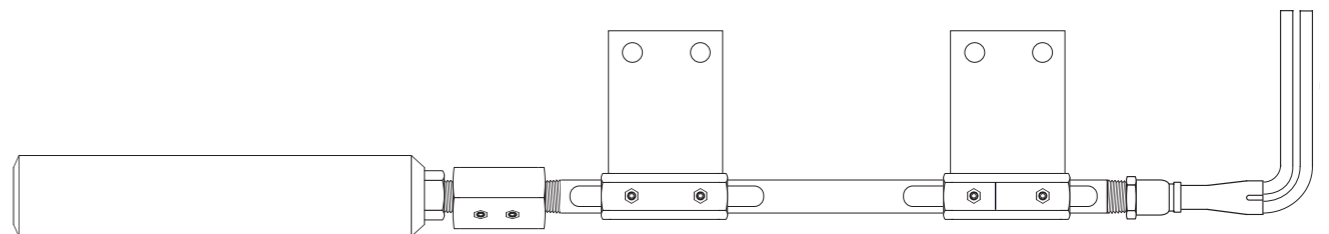

Heavy duty impeder support system

Consists of 2 x hanger blades & coupling. Pipe/impeder not included.

# Hollow impeders

Hollow impeders have a centre hole running through the impeder assembly and are available in through-flow and return-flow configurations, with many combinations of inside and outside diameters. Typically they are used for inside scarfing applications with hydraulic or mechanically actuated heads. Other applications include:

- Internal painting and coating of welded tube
- In-line bright annealing
- Special instrumentation tubing where wiring or optical fibre is laid inside the tube during production

We recommend against using a larger impeder I.D. (centre hole) than necessary, since this reduces the amount of ferrite in the impeder and may lower efficiency. It also increases the complexity of assembly which impacts the final price.

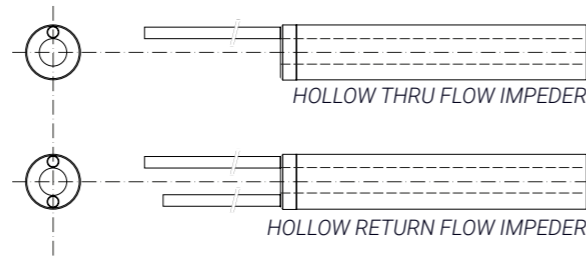

Impeder length	230 mm	330 mm	430 mm	530 mm	630 mm	830 mm	1030 mm
Price multiplier	x 1.00	x 1.45	x 1.90	x 2.45	x 2.85	x 3.80	x 4.75

# Hollow through-flow impeders

Impeder O.D. (mm)	Center hole I.D.									
	4.8 mm 0.188"	6.4 mm 0.250"	8.0 mm 0.313"	9.5 mm 0.375"	12.7 mm 0.500"	15.9 mm 0.625"	19.1 mm 0.750"	25.4 mm 1.000"	31.8 mm 1.250"	38.1 mm 1.500"
13.0 mm*	█									
14.0 mm	█									
15.0 mm	█									
16.0 mm	█	█								
17.0 mm	█	█								
18.0 mm	█	█								
19.0 mm	█	█	█							
20.0 mm	█	█	█							
21.0 mm	█	█	█							
22.0 mm	█	█	█	█						
23.0 mm	█	█	█	█						
24.0 mm	█	█	█	█	█					
25.0 mm	█	█	█	█	█					
28.0 mm	█	█	█	█	█	█				
31.0 mm	█	█	█	█	█	█	█			
34.0 mm	█	█	█	█	█	█	█	█		
37.0 mm	█	█	█	█	█	█	█	█		
40.0 mm	█	█	█	█	█	█	█	█		
43.0 mm	█	█	█	█	█	█	█	█		
46.0 mm	█	█	█	█	█	█	█	█	█	
50.0 mm	█	█	█	█	█	█	█	█	█	
57.2 mm	█	█	█	█	█	█	█	█	█	█
63.5 mm	█	█	█	█	█	█	█	█	█	█
69.9 mm	█	█	█	█	█	█	█	█	█	█
76.2 mm	█	█	█	█	█	█	█	█	█	█

# Hollow return-flow impeders

Impeder O.D. (mm)	Center hole I.D.									
	4.8 mm 0.188"	6.4 mm 0.250"	8.0 mm 0.313"	9.5 mm 0.375"	12.7 mm 0.500"	15.9 mm 0.625"	19.1 mm 0.750"	25.4 mm 1.000"	31.8 mm 1.250"	38.1 mm 1.500"
13.0 mm*	█									
14.0 mm	█									
15.0 mm	█									
16.0 mm	█	█								
17.0 mm	█	█								
18.0 mm	█	█								
19.0 mm	█	█	█							
20.0 mm	█	█	█							
21.0 mm	█	█	█							
22.0 mm	█	█	█	█						
23.0 mm	█	█	█	█						
24.0 mm	█	█	█	█	█					
25.0 mm	█	█	█	█	█					
28.0 mm	█	█	█	█	█	█				
31.0 mm	█	█	█	█	█	█	█			
34.0 mm	█	█	█	█	█	█	█	█		
37.0 mm	█	█	█	█	█	█	█	█		
40.0 mm	█	█	█	█	█	█	█	█		
43.0 mm	█	█	█	█	█	█	█	█		
46.0 mm	█	█	█	█	█	█	█	█	█	
50.0 mm	█	█	█	█	█	█	█	█	█	
57.2 mm	█	█	█	█	█	█	█	█	█	█
63.5 mm	█	█	█	█	█	█	█	█	█	█
69.9 mm	█	█	█	█	█	█	█	█	█	█
76.2 mm	█	█	█	█	█	█	█	█	█	█

\* Maximum centre hole I.D. for 13mm impeder is 4mm  
Green blocks indicate standard offering

# Impeder clusters

Impeder clusters are a cost-effective alternative to individual impeders for larger diameter pipes. Clusters are available in many configurations for OD 127mm – 610mm (5” – 24”). ENRX’s ‘Quick Change System’ uses Parker quick-connect or Presto push fit couplings to allow rapid replacement of the impeders, often without having to cut the pipe. These fittings also eliminate damaged threads and impeder alignment problems.

Impeders do not usually need to form a circle inside large diameter pipes. Larger clusters therefore typically consist of two arcs of impeders positioned close to the top inside surface of the pipe. In certain cases a rectangular impeder at the top centre position is used for maximum welding efficiency.

Cluster assemblies consist of an aluminium manifold with a clamping system. Also included is a spacer plate to maintain correct alignment of the impeders. Coolant connections are flexible hoses or copper tubing. Return flow cluster assemblies are available as an option.

For pipes larger than OD 8” (219mm), clusters of rectangular impeders are an efficient solution. Rectangular impeders are also the preferred method in cases where the product is welded as a square, rectangle or step beam section. Our 1” x 2” rectangular impeders are available in lengths up to 60” (1525mm).

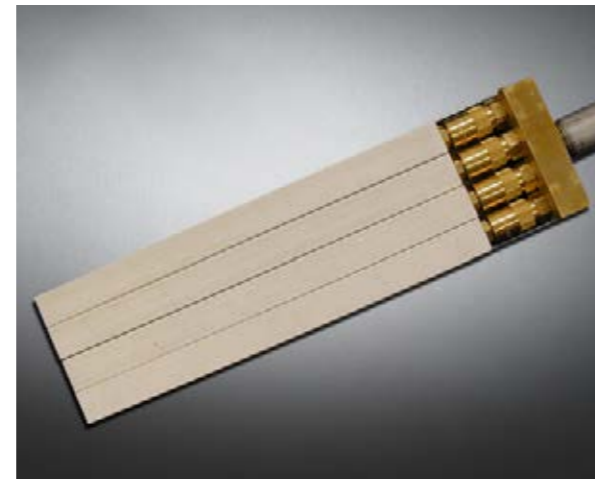

## Hybrid impeder cluster assemblies

Pipe OD	Impeder Length							
	230mm	330mm	430mm	530mm	630mm	830mm	1030mm	1230mm
168mm (6.625")	CLUS-168-230	CLUS-168-330	CLUS-168-430	CLUS-168-530	CLUS-168-630	CLUS-168-830	CLUS-168-1030	CLUS-168-1230
193mm (7.625")	CLUS-193-230	CLUS-193-330	CLUS-193-430	CLUS-193-530	CLUS-193-630	CLUS-193-830	CLUS-193-1030	CLUS-193-1230
219mm (8.625")		CLUS-219-330	CLUS-219-430	CLUS-219-530	CLUS-219-630	CLUS-219-830	CLUS-219-1030	CLUS-219-1230
244mm (9.625")		CLUS-244-330	CLUS-244-430	CLUS-244-530	CLUS-244-630	CLUS-244-830	CLUS-244-1030	CLUS-244-1230
273mm (12.75")			CLUS-273-430	CLUS-273-530	CLUS-273-630	CLUS-273-830	CLUS-273-1030	CLUS-273-1230
355mm (14")			CLUS-355-430	CLUS-355-530	CLUS-355-630	CLUS-355-830	CLUS-355-1030	CLUS-355-1230
406mm (16")			CLUS-406-430	CLUS-406-530	CLUS-406-630	CLUS-406-830	CLUS-406-1030	CLUS-406-1230
457mm (18")			CLUS-457-430	CLUS-457-530	CLUS-457-630	CLUS-457-830	CLUS-457-1030	CLUS-457-1230
508mm (20")				CLUS-508-530	CLUS-508-630	CLUS-508-830	CLUS-508-1030	CLUS-508-1230
559mm (22")					CLUS-559-630	CLUS-559-830	CLUS-559-1030	CLUS-559-1230
610mm (24")					CLUS-610-630	CLUS-610-830	CLUS-610-1030	CLUS-610-1230

These are complete cluster assemblies with impeders as detailed in diagrams below  
Length shown is for impeders only, total assembly will be longer

## Replacement quick change impeders for cluster assemblies

Pipe OD	Impeder Length							
	230mm	330mm	430mm	530mm	630mm	830mm	1030mm	1230mm
22mm	TFIE-22-230	TFIE-22-330	TFIE-22-430	TFIE-22-530	TFIE-22-630	TFIE-22-830	TFIE-22-1030	TFIE-22-1230
31mm	TFIE-31-230	TFIE-31-330	TFIE-31-430	TFIE-31-530	TFIE-31-630	TFIE-31-830	TFIE-31-1030	TFIE-31-1230
Rectangular (51mm x 25.4mm)	REC-230T	REC-330T	REC-430T	REC-530T	REC-630T	REC-830T	REC-1030T	REC-1230T

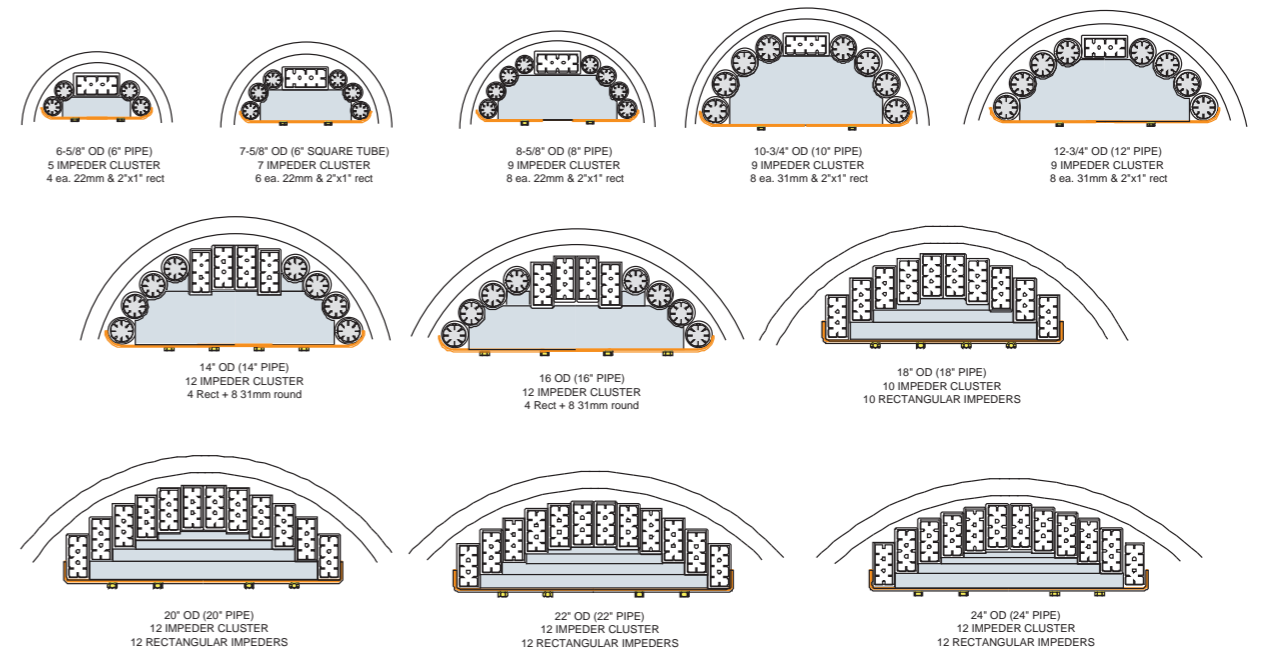

# Rectangular impeder clusters

ENRX also offers a full range of rectangular manifolds for pipe mills welding squares and rectangular hollow sections 'in shape'. Full details of the configurations available can be seen below.

## Common rectangular through flow impeder clusters for profiles

Impeder configuration (refer to diagram below)	Impeder Length						
	230mm	330mm	430mm	530mm	630mm	830mm	1030mm
H1	REC-H1-230	REC-H1-330	REC-H1-430	REC-H1-530	REC-H1-630	REC-H1-830	REC-H1-1030
V1	REC-V1-230	REC-V1-330	REC-V1-430	REC-V1-530	REC-V1-630	REC-V1-830	REC-V1-1030
H2V	REC-H2V-230	REC-H2V-330	REC-H2V-430	REC-H2V-530	REC-H2V-630	REC-H2V-830	REC-H2V-1030
V2H	REC-V2H-230	REC-V2H-330	REC-V2H-430	REC-V2H-530	REC-V2H-630	REC-V2H-830	REC-V2H-1030
H3V	REC-H3V-230	REC-H3V-330	REC-H3V-430	REC-H3V-530	REC-H3V-630	REC-H3V-830	REC-H3V-1030
V3H	REC-V3H-230	REC-V3H-330	REC-V3H-430	REC-V3H-530	REC-V3H-630	REC-V3H-830	REC-V3H-1030
H4V	REC-H4V-230	REC-H4V-330	REC-H4V-430	REC-H4V-530	REC-H4V-630	REC-H4V-830	REC-H4V-1030
V4H	REC-V4H-230	REC-V4H-330	REC-V4H-430	REC-V4H-530	REC-V4H-630	REC-V4H-830	REC-V4H-1030
V5H	REC-V5H-230	REC-V5H-330	REC-V5H-430	REC-V5H-530	REC-V5H-630	REC-V5H-830	REC-V5H-1030
V6H	REC-V6H-230	REC-V6H-330	REC-V6H-430	REC-V6H-530	REC-V6H-630	REC-V6H-830	REC-V6H-1030

The above part numbers include: manifold, support tray and impeders  
The length shown is impeder length, total system including manifold and tray will be longer

## Replacement manifold

Through Flow Manifold	Number of impeders					
	1	2	3	4	5	6
REC-MAN-1	REC-MAN-2	REC-MAN-3	REC-MAN-4	REC-MAN-5	REC-MAN-6	

## Replacement support tray

Tray for 230mm long impeders	Number of impeders					
	1	2	3	4	5	6
REC-ST-1-230	REC-ST-2-230	REC-ST-3-230	REC-ST-4-230	REC-ST-5-230	REC-ST-6-230	
REC-ST-1-330	REC-ST-2-330	REC-ST-3-330	REC-ST-4-330	REC-ST-5-330	REC-ST-6-330	
REC-ST-1-430	REC-ST-2-430	REC-ST-3-430	REC-ST-4-430	REC-ST-5-430	REC-ST-6-430	
REC-ST-1-530	REC-ST-2-530	REC-ST-3-530	REC-ST-4-530	REC-ST-5-530	REC-ST-6-530	
REC-ST-1-630	REC-ST-2-630	REC-ST-3-630	REC-ST-4-630	REC-ST-5-630	REC-ST-6-630	
REC-ST-1-830	REC-ST-2-830	REC-ST-3-830	REC-ST-4-830	REC-ST-5-830	REC-ST-6-830	
REC-ST-1-1030	REC-ST-2-1030	REC-ST-3-1030	REC-ST-4-1030	REC-ST-5-1030	REC-ST-6-1030	

## Heavy duty hanger blade assemblies

Impeder configurations	Support tube nominal size	
	1/2"	1"
manifolds using 1-2 impeders	RFSS-HD-0.5	n/a
manifolds using 3-6 impeders	n/a	RFSS-HD-1

## Replacement quick change rectangular impeders

Impeder size (51mm x25.4mm)	Impeder Length						
	230mm	330mm	430mm	530mm	630mm	830mm	1030mm
Standard through flow type	REC-230T	REC-330T	REC-430T	REC-530T	REC-630T	REC-830T	REC-1030T
Exposed ferrite type	REC-230TE	REC-330TE	REC-430TE	REC-530TE	REC-630TE	REC-830TE	REC-1030TE

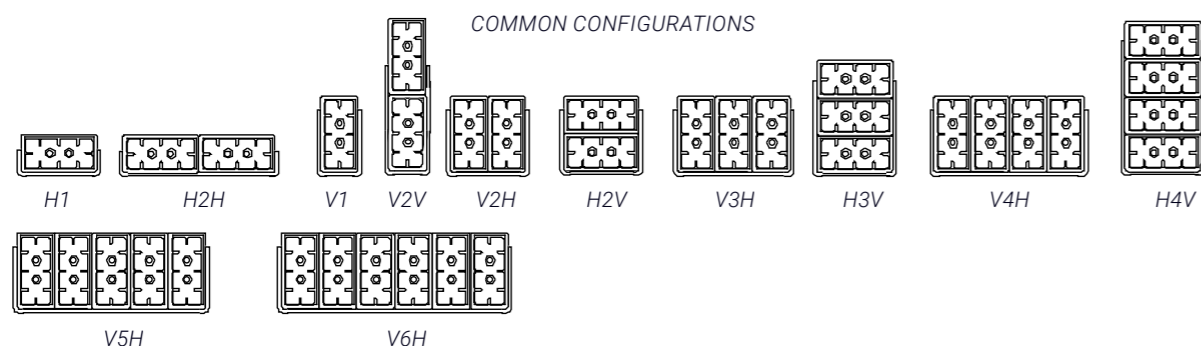

# Integral mandrel impeders

ENRX's integral mandrel impeders are the most economical and efficient method of I.D. scarfing or bead rolling with induction welding of tubing up to 3" in diameter.

the tow rod. Most integral mandrel impeders can be provided with pipe threads at both ends. This facilitates the use of standard threaded pipe as a tow rod.

These impeders use an internal stainless steel tie rod or mandrel which is threaded and pinned to heavy duty hexagonal bushings at both ends. The mandrel is surrounded by either a single cylindrical ferrite tube, or a cluster of smaller-diameter ferrite rods. The entire assembly is enclosed in a heat-resistant, non-metallic outer cover that protects the ferrite and directs the coolant. The hexagonal bushings have internal threads and setscrews that let the impeder be 'locked' to

I.D. scarfing systems often do not allow enough space for ferrite. This reduces welding efficiency, and can cause excessive heating of the tow rod. ENRX's integral mandrel impeders maximize efficiency, and provide the mechanical stability needed for quality I.D. flash control.

Tow rods used with our integral impeders can be made from carbon steel. This is less expensive—and often stronger—than the austenitic stainless steel typically used by most tow rods.

## Integral mandrel impeders

Impeder O.D.(mm)	Fixing thread/pitch	Internal tie rod Ø	Part number (through flow)	Part number (return flow)
13mm	3/8" - 24	3/16" (4.76mm)	IMI-13	n/a
14mm	3/8" - 24	3/16" (4.76mm)	IMI-14	n/a
15mm	3/8" - 24	1/4" (6.35mm)	IMI-15	n/a
16mm	3/8" - 24	1/4" (6.35mm)	IMI-16	IMI-16R
17mm	3/8" - 24	1/4" (6.35mm)	IMI-17	IMI-17R
18mm	3/8" - 24	1/4" (6.35mm)	IMI-18	IMI-18R
19mm	1/2" - 20	1/4" (6.35mm)	IMI-19	IMI-19R
20mm	1/2" - 20	1/4" (6.35mm)	IMI-20	IMI-20R
21mm	1/2" - 20	1/4" (6.35mm)	IMI-21	IMI-21R
22mm	5/8" - 18	5/16" (7.94mm)	IMI-22	IMI-22R
23mm	5/8" - 18	5/16" (7.94mm)	IMI-23	IMI-23R
24mm	5/8" - 18	5/16" (7.94mm)	IMI-24	IMI-24R
25mm	5/8" - 18	3/8" (9.52mm)	IMI-25	IMI-25R
28mm	5/8" - 18	3/8" (9.52mm)	IMI-28	IMI-28R
31mm	5/8" - 18	3/8" (9.52mm)	IMI-31	IMI-31R
34mm	3/4" - 16	1/2" (12.7mm)	IMI-34	IMI-34R
37mm	3/4" - 16	1/2" (12.7mm)	IMI-37	IMI-37R
40mm	3/4" - 16	1/2" (12.7mm)	IMI-40	IMI-40R
43mm	3/4" - 16	5/8" (15.88mm)	IMI-43	IMI-43R
46mm	3/4" - 16	5/8" (15.88mm)	IMI-46	IMI-46R
50mm	3/4" - 16	5/8" (15.88mm)	IMI-50	IMI-50R
57mm	1" - 12	3/4" (19.05mm)	IMI-57	IMI-57R
64mm	1" - 12	3/4" (19.05mm)	IMI-64	IMI-64R
70mm	1" - 12	3/4" (19.05mm)	IMI-70	IMI-70R
76mm	1" - 12	3/4" (19.05mm)	IMI-76	IMI-76R

Standard impeder length for integral mandrel impeders is 267mm  
Integral mandrel impeders are available in other lengths as listed below with pricing multiplication factor

Impeder length	Price multiplication
267mm	x 1.00
368mm	x 1.45
470mm	x 1.90





# Impeder/induction coil selection guide

The selection of impeder and inductor will significantly influence the performance of your high frequency generator and how much energy you consume during the tube manufacturing process. Using poor quality components will at the very least cost you money and in the worst case could result in the welder operating in an 'unsafe' position. This effectively means outside of the load matching range of the machine.

Correct sizing of the impeder and inductor is not completely straightforward as it can vary based on a number of factors including:

- Diameter/thickness ratio of tube being produced
- Condition of strip
- Condition of cross weld between coils
- Diameter and configuration of welding rolls
- Strip material
- Form of tube at welding rolls

Of course these are just some of the factors that can influence but it is still good practice to follow some basic rules as a good starting point. Below you can see a diagram that gives guidance on dimensions to consider for sizing and positioning.

### Impeder

Many publications stress the importance of positioning the impeder with the end of the ferrite just past the centreline of the welding rolls but we know from experience this is hardly ever practiced in reality. Of course it is the best condition from an electrical efficiency standpoint but it also reduces the life of the impeder due to burning of the casing. It is about finding a balance for continuous running so positioning the end of the impeder a little back from the welding point is probably more realistic. However it is important to understand that doing this will lead to increased 'induction heating' of any metallic parts that may be part of the end of the impeder assembly.

### IMPEDER AND INDUCTION COIL SELECTION GUIDE

Distance A is the induction coil length and typically established by welder manufacturer. Distance B is the side weld roll diameter and typically established by mill and/or roll tooling engineer. Ideally both distance A and B are kept as short as possible for optimal V Length. Minimum Impeder length  $F = A + B$ . For tubes 5.5" I.D. and below, impeder diameter C should be approx. 80% of D the tube I.D. Larger tubes typically use clusters of ferrite and larger cluster support rods to handle correct position and weight. Please contact ENRX to properly size and quote cluster arrangements. Induction Coil I.D. E is typically 1.2-1.5 times the O.D. of tube being welded.

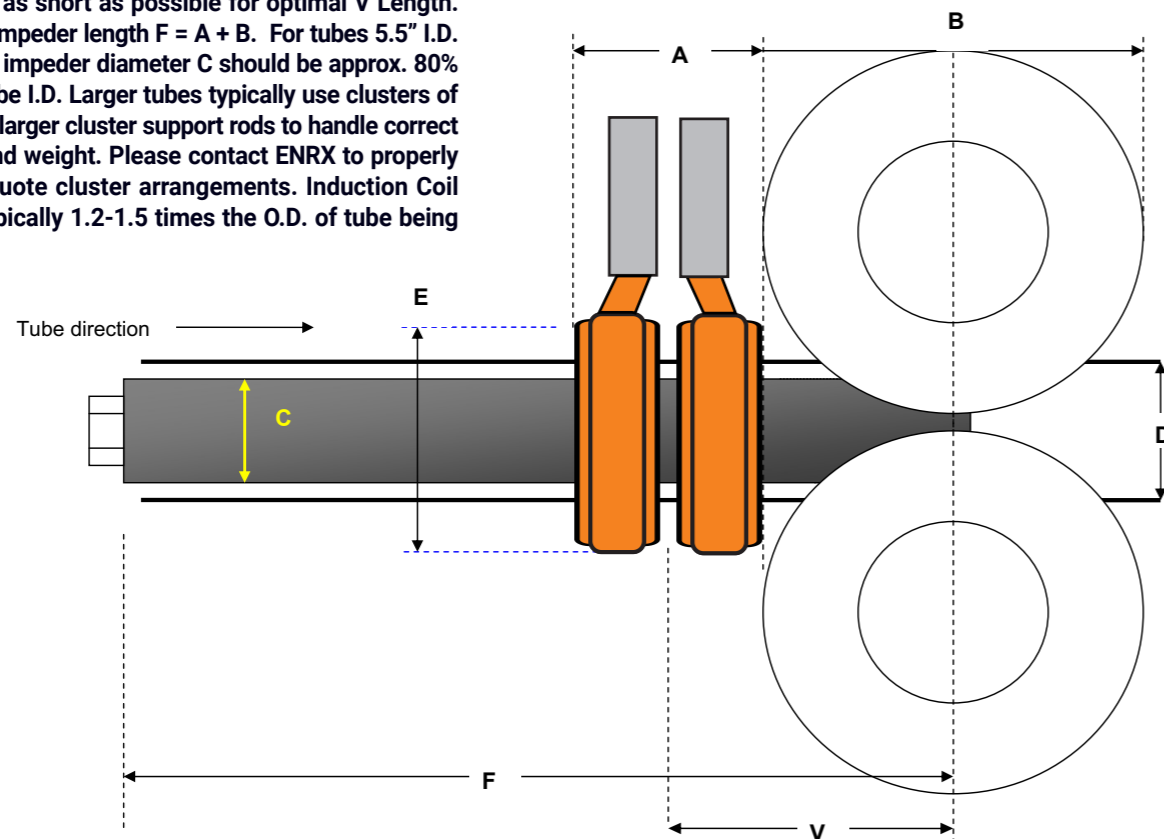

Ferrite length is really important, particularly when welding roll diameter is excessive or as tube diameters get larger. Probably the most common reason for excessive welding power consumption is insufficient ferrite length within the impeder. We are always happy to advise on selection of correct impeder length for your application.

Impeder cooling is also critical and where possible coolant temperature should be kept below 25°C as increases above this will need much more flow to achieve the same level of cooling. In some cases with small impeders it can be beneficial to use a chiller to retain the inlet temperature at something around 10°C

### Induction coils

Choosing the correct induction coil for the tube mill in question is very important, tubular coils and some banded versions will be 'direction dependent'. The coil should be wound the correct way to avoid increasing the length of the vee and also creating 'uneven' vee lengths. In the worst case on thinner wall materials this can lead to disproportionate heating on opposite sides of the open vee.

This is provided as a guide, you should always consider the specific mill in question.

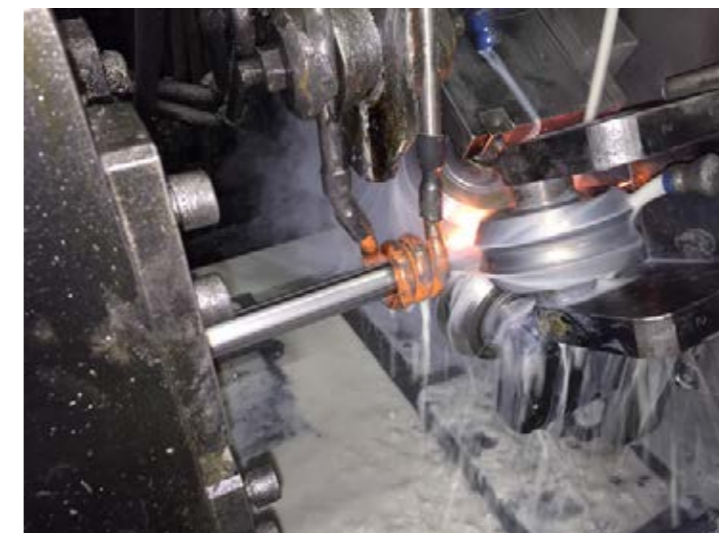
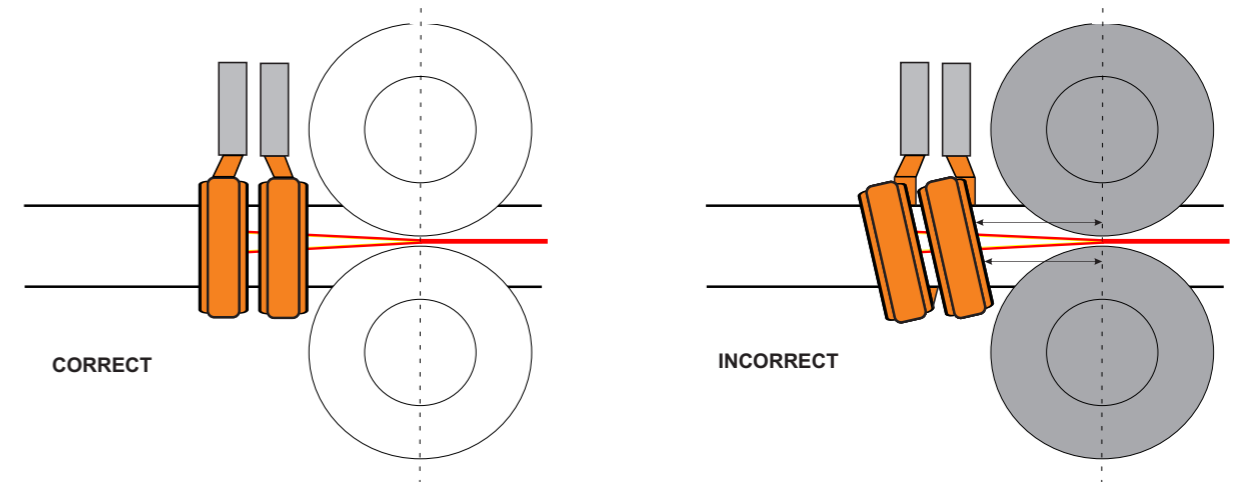

# Induction welding coils

Good induction coil design is essential to achieve the high efficiency offered by solid-state welders. Unlike earlier vacuum tube welders, transistor inverters operate at high currents and low voltages. Coil currents can exceed 3,000 A, ten times higher than a typical vacuum tube welder. The power loss in a circuit due to resistance is given by  $I^2 \times R$ , so it is essential to minimize coil resistance. With 3,000A in a coil with a resistance of 0.01  $\Omega$ , the power lost in the coil is 90 kW. This can easily eliminate any efficiency gains due to the higher efficiency of solid state welders.

The resistance of copper rises with temperature. All coils must therefore be designed for optimum performance. When needed, ENRX coils are fabricated from 99.9% pure, oxygenfree, high conductivity copper, with silver brazed joints and advanced cooling systems.

Most solid-state welders use single or two-turn coils. Two turn coils are available with either left-hand, right-hand or universal helix directions OR also parallel

(universal) coils. The choice of direction depends on the weld roll configuration and mill direction and should be selected to provide the shortest vee length. In general left hand helix coils are used when mill direction is left to right and right hand helix coils are used for right to left mills. Universal coils are not direction dependant and in most cases are the best choice

Single-turn coils are often supplied in two sections. This means the coil can be replaced without cutting the pipe. ENRX two-turn universal coils can also be supplied in a split type for fast changeovers with virtually zero scrap. Although coil design for vacuum tube welders is less critical, a well-designed coil can still significantly boost efficiency.

The size list on the facing page covers our most common coil types. We also offer a wide range of specialized coils and coil holders for all types of high-frequency welders.



# Induction welding coils

Standard offering shown in green

Photo ref.	A-2		A-3		B-1			B-2			B-3			C-1		C-2		D-1		D-2		E-1		E-2	
	Tubular coils/tubular leads		Banded coils/tubular leads		Universal coils		Plate Mounted banded coils		Split banded coils																
Inside $\varnothing$ (mm)	2 turns	3 turns	1 turn	2 turns	3 turns	1 turn	2 turns	1 turn	2 turns	1 turn	2 turns	1 turn	2 turns	1 turn	2 turns	1 turn	2 turns	1 turn	2 turns	1 turn	2 turns	1 turn	2 turns		
12			n/a	n/a	n/a	n/a	n/a	n/a	n/a	n/a	n/a	n/a	n/a	n/a	n/a	n/a	n/a	n/a	n/a	n/a	n/a	n/a	n/a		
14			n/a	n/a	n/a	n/a	n/a	n/a	n/a	n/a	n/a	n/a	n/a	n/a	n/a	n/a	n/a	n/a	n/a	n/a	n/a	n/a	n/a		
16			n/a	n/a	n/a	n/a	n/a	n/a	n/a	n/a	n/a	n/a	n/a	n/a	n/a	n/a	n/a	n/a	n/a	n/a	n/a	n/a	n/a		
18			n/a	n/a	n/a	n/a	n/a	n/a	n/a	n/a	n/a	n/a	n/a	n/a	n/a	n/a	n/a	n/a	n/a	n/a	n/a	n/a	n/a		
19			n/a	n/a	n/a	n/a	n/a	n/a	n/a	n/a	n/a	n/a	n/a	n/a	n/a	n/a	n/a	n/a	n/a	n/a	n/a	n/a	n/a		
20			n/a	n/a	n/a	n/a	n/a	n/a	n/a	n/a	n/a	n/a	n/a	n/a	n/a	n/a	n/a	n/a	n/a	n/a	n/a	n/a	n/a		
22			n/a	n/a	n/a	n/a	n/a	n/a	n/a	n/a	n/a	n/a	n/a	n/a	n/a	n/a	n/a	n/a	n/a	n/a	n/a	n/a	n/a		
25								n/a	n/a	n/a	n/a	n/a	n/a	n/a	n/a	n/a	n/a	n/a	n/a	n/a	n/a	n/a	n/a		
28								n/a	n/a	n/a	n/a	n/a	n/a	n/a	n/a	n/a	n/a	n/a	n/a	n/a	n/a	n/a	n/a		
31								n/a	n/a	n/a	n/a	n/a	n/a	n/a	n/a	n/a	n/a	n/a	n/a	n/a	n/a	n/a	n/a		
34								n/a	n/a	n/a	n/a	n/a	n/a	n/a	n/a	n/a	n/a	n/a	n/a	n/a	n/a	n/a	n/a		
37								n/a	n/a	n/a	n/a	n/a	n/a	n/a	n/a	n/a	n/a	n/a	n/a	n/a	n/a	n/a	n/a		
40								n/a	n/a	n/a	n/a	n/a	n/a	n/a	n/a	n/a	n/a	n/a	n/a	n/a	n/a	n/a	n/a		
43								n/a	n/a	n/a	n/a	n/a	n/a	n/a	n/a	n/a	n/a	n/a	n/a	n/a	n/a	n/a	n/a		
46								n/a	n/a	n/a	n/a	n/a	n/a	n/a	n/a	n/a	n/a	n/a	n/a	n/a	n/a	n/a	n/a		
50								n/a	n/a	n/a	n/a	n/a	n/a	n/a	n/a	n/a	n/a	n/a	n/a	n/a	n/a	n/a	n/a		
55								n/a	n/a	n/a	n/a	n/a	n/a	n/a	n/a	n/a	n/a	n/a	n/a	n/a	n/a	n/a	n/a		
60								n/a	n/a	n/a	n/a	n/a	n/a	n/a	n/a	n/a	n/a	n/a	n/a	n/a	n/a	n/a	n/a		
65								n/a	n/a	n/a	n/a	n/a	n/a	n/a	n/a	n/a	n/a	n/a	n/a	n/a	n/a	n/a	n/a		
70								n/a	n/a	n/a	n/a	n/a	n/a	n/a	n/a	n/a	n/a	n/a	n/a	n/a	n/a	n/a	n/a		
75								n/a	n/a	n/a	n/a	n/a	n/a	n/a	n/a	n/a	n/a	n/a	n/a	n/a	n/a	n/a	n/a		
80								n/a	n/a	n/a	n/a	n/a	n/a	n/a	n/a	n/a	n/a	n/a	n/a	n/a	n/a	n/a	n/a		
85								n/a	n/a	n/a	n/a	n/a	n/a	n/a	n/a	n/a	n/a	n/a	n/a	n/a	n/a	n/a	n/a		
90								n/a	n/a	n/a	n/a	n/a	n/a	n/a	n/a	n/a	n/a	n/a	n/a	n/a	n/a	n/a	n/a		
95																									
100																									
105																									
110																									
115																									
120																									
125																									
130																									
140																									
145																									
150																									

Induction coils are offered as standard with 9.52mm or 12.7mm diameter leads and maximum length 300mm  
 Extended length and other diameter leads available on request  
 Also available are 17mm gas pipe with hose barbs (Emmedi/Elestar style)  
 Offset leads available at additional cost

## Large diameter flange coils & coil holders

ENRX also supplies a full range of large flange mounted inductors for any kind of HF generator. These can be supplied with integral cooling using brazed cooling pipes or configured for external spray cooling for pipe diameters up to 26" (660mm). We also offer a range of standard and bespoke coil holders.



# Ferrite for high-frequency tube welding

### Ferrite specifications

A theoretically perfect ferrite for impeders would be able to support an infinite amount of magnetic flux, and would have zero losses, requiring no cooling. Unfortunately such a material has yet to be developed, however there are vast differences in the magnetic and electrical properties of commercially manufactured ferrites, which permit them to be tailored to the application in which they are used. Most of the ferrite produced in the form of rods or tubes is designed for antenna rods in radio receivers, where it operates at high frequencies, but at very low power levels. Impeder ferrite operates at very high power levels, but at relatively low frequencies of 200 - 500 kHz.

**Choosing the wrong grade of ferrite for use in impeders can have a disastrous effect on the efficiency of the welding process, and the life of the impeder.**

All ferromagnetic materials are limited in the amount of magnetic flux that they can support. This is known as the saturation flux density, and it is normally expressed in Gauss or Teslas (10,000 Gauss = 1 Tesla). At high power densities, modern HF welders can establish very high flux densities with an impeder, so it is important to choose a grade of ferrite that will support this flux without saturation.

Ferrite used in impeders also requires cooling because electrical & magnetic losses in the material cause waste heat to be generated. The lower the losses in the ferrite, the less cooling required. Ferrite that operates at a lower temperature & which undergoes less thermal cycling will last longer & require less frequent replacement. Saturation flux density & magnetic permeability both decrease at higher temperatures, so keeping the ferrite cool greatly improves its performance.

The ferrite that we sell has been developed to our specifications over many years by leading manufacturers around the world, and it has been specifically formulated for high saturation flux density, high permeability and the lowest possible losses.

Many customers invest hundreds of thousands of Euros on high quality solid state welding generators and then attempt to save cost by purchasing cheap low quality ferrites, this is complete false economy and will end up costing them tens of thousands in increased energy costs due to poor welding efficiency.

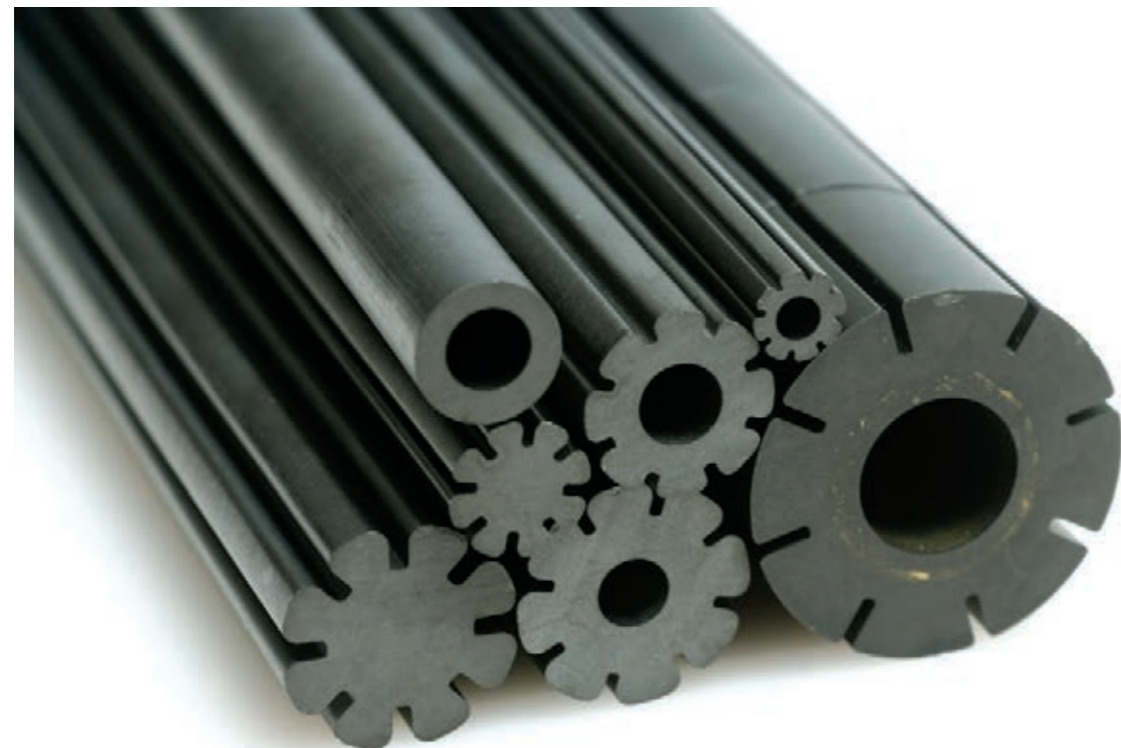

# Ferrite types

Ferrite is the most critical component in HF welding process with regard to energy consumption, it therefore makes complete sense to select good quality ferrite for your impeders. Our premium HR4B/HR5 ferrite cores offer the highest possible specification and performance for this application, often these cores will require half the amount of cooling compared to cheap low quality ferrites. HR4B/HR5 will tackle the toughest applications and give the best efficiency results time after time.

We also offer our own Ferromax brand of high performance ferrite for customers who are looking

for higher quantities at competitive pricing. Ferromax is manufactured for us to our specification and with a wide range of sizes and good stocks this is often a preferred product for resellers.

We offer four (4) different types of ferrite shape as shown below. Solid fluted cores and hollow fluted cores are stocked. Flat sided round and hollow round ferrites are available to order. Our full range of ferrite cores available can be seen on pages 22 & 23.

We also offer a cutting service for ferrite cores.

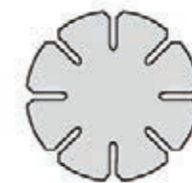

Solid fluted cores  
MRS – HR4B/HR5  
FRS - Ferromax

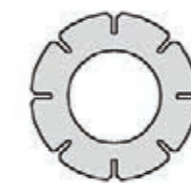

Hollow fluted cores  
MRSH – HR4B/HR5  
FRSH - Ferromax

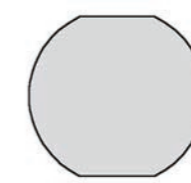

Flat sided round cores  
MRF – HR4B  
FRF - Ferromax

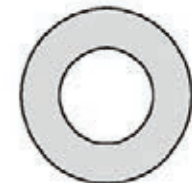

Hollow round cores  
MRH – HR4B  
FRH - Ferromax



## Hollow Fluted Ferrite cores

HR4B/HR5				
O.D.	I.D.	Part No.	Tray Qty*	Box Qty
7mm	2mm	MRSH-7x2x200	17	170
8mm	4mm	MRSH-8x4x200	17	170
9mm	2mm	MRSH-9x2x200	17	153
9mm	4mm	MRSH-9x4x200	17	153
10mm	3mm	MRSH-10x3x200	17	153
10mm	5mm	MRSH-10x5x200	17	153
10.5mm	6mm	MRSH-10.5x6x200	17	153
11mm	3mm	MRSH-11x3x200	17	136
11mm	5mm	MRSH-11x5x200	17	136
12mm	3mm	MRSH-12x3x200	12	96
12mm	5mm	MRSH-12x5x200	12	96
12.5mm	7mm	MRSH-12.5x7x200	12	96
13mm	5mm	MRSH-13x5x200	12	96
13mm	7mm	MRSH-13x7x200	12	96
13.5mm	7mm	MRSH-13.5x7x200	12	96
14mm	5mm	MRSH-14x5x200	12	96
14mm	7mm	MRSH-14x7x200	12	96
15mm	5mm	MRSH-15x5x200	12	84
15mm	7mm	MRSH-15x7x200	12	84
15mm	8mm	MRSH-15x8x200	12	84
16mm	5mm	MRSH-16x5x200	12	84
16mm	8mm	MRSH-16x8x200	12	84
17mm	5mm	MRSH-17x5x200	10	60
17mm	8mm	MRSH-17x8x200	10	60
18mm	6mm	MRSH-18x6x200	10	60
18mm	9mm	MRSH-18x9x200	10	60
19mm	6mm	MRSH-19x6x200	10	60
19mm	9mm	MRSH-19x9x200	10	60
20mm	6mm	MRSH-20x6x200	8	48
20mm	10mm	MRSH-20x10x200	8	48
21mm	10mm	MRSH-21x10x200	8	48
21mm	11mm	MRSH-21x11x200	8	48
22mm	6mm	MRSH-22x6x200	8	40
22mm	10mm	MRSH-22x10x200	8	40
23mm	6mm	MRSH-23x6x200	8	40
23mm	11mm	MRSH-23x11x200	8	40
24mm	11mm	MRSH-24x11x200	8	40
24mm	13mm	MRSH-24x13x200	8	40
25mm	10mm	MRSH-25x10x200	7	35
25mm	12mm	MRSH-25x12x200	7	35
26mm	10mm	MRSH-26x10x200	7	35
26mm	11mm	MRSH-26x11x200	7	35
26mm	13mm	MRSH-26x13x200	7	35
27mm	8mm	MRSH-27x8x200	7	35
27mm	11mm	MRSH-27x11x200	7	35
27mm	13mm	MRSH-27x13x200	7	35
28mm	13mm	MRSH-28x13x200	6	24
29mm	14mm	MRSH-29x14x200	6	24
30mm	15mm	MRSH-30x15x200	6	24
32mm	16mm	MRSH-32x16x200	5	20
33mm	14mm	MRSH-33x14x200	5	20
34mm	17mm	MRSH-34x17x200	5	20
36mm	14mm	MRSH-36x14x200	5	20
36mm	18mm	MRSH-36x18x200	5	20
39mm	20mm	MRSH-39x20x200	5	20
40mm	20mm	MRSH-40x20x200	5	15
42mm	21mm	MRSH-42x20x200	4	12
45mm	20mm	MRSH-45x20x200	4	12
46mm	23mm	MRSH-46x23x200	4	12
48mm	24mm	MRSH-48x24x200	3	6
49mm	20mm	MRSH-49x20x200	3	6
55mm	27mm	MRSH-55x27x200	3	6
62mm	31mm	MRSH-62x31x200	2	4
65mm	32mm	MRSH-65x32x200	2	4
69mm	35mm	MRSH-69x35x200	2	4
73mm	36mm	MRSH-73x36x200	2	4
80mm	40mm	MRSH-80x40x200	2	2
95mm	48mm	MRSH-95x48x200	1	2
45mm	20mm	RRSH-45x20x100		

Ferromax		
O.D.	I.D.	Part No.
7mm	2mm	FRSH-7x2x200
8mm	3mm	FRSH-8x3x200
9mm	3mm	FRSH-9x3x200
10mm	3mm	FRSH-10x3x200
10mm	5mm	FRSH-10x5x200
11mm	3mm	FRSH-11x3x200
11mm	5mm	FRSH-11x5x200
12mm	3mm	FRSH-12x3x200
12mm	5mm	FRSH-12x5x200
13mm	5mm	FRSH-13x5x200
13mm	7mm	FRSH-13x7x200
14mm	5mm	FRSH-14x5x200
14mm	7mm	FRSH-14x7x200
15mm	5mm	FRSH-15x5x200
15mm	7mm	FRSH-15x7x200
16mm	5mm	FRSH-16x5x200
16mm	8mm	FRSH-16x8x200
17mm	5mm	FRSH-17x5x200
17mm	7mm	FRSH-17x7x200
18mm	6mm	FRSH-18x6x200
18mm	9mm	FRSH-18x9x200
19mm	6mm	FRSH-19x6x200
19mm	9mm	FRSH-19x9x200
20mm	6mm	FRSH-20x6x200
20mm	10mm	FRSH-20x10x200
21mm	10mm	FRSH-21x10x200
22mm	6mm	FRSH-22x6x200
22mm	10mm	FRSH-22x10x200
23mm	6mm	FRSH-23x6x200
23mm	11mm	FRSH-23x11x200
24mm	12mm	FRSH-24x12x200
25mm	10mm	FRSH-25x10x200
25mm	12mm	FRSH-25x12x200
26mm	10mm	FRSH-26x10x200
26mm	13mm	FRSH-26x13x200
27mm	8mm	FRSH-27x8x200
27mm	13mm	FRSH-27x13x200
28mm	13mm	FRSH-28x13x200
29mm	14mm	FRSH-29x14x200
30mm	15mm	FRSH-30x15x200
32mm	16mm	FRSH-32x16x200
33mm	15mm	FRSH-33x15x200
34mm	17mm	FRSH-34x17x200
36mm	18mm	FRSH-36x18x200
38mm	19mm	FRSH-38x19x200
40mm	20mm	FRSH-40x20x200
42mm	21mm	FRSH-42x21x200
45mm	20mm	FRSH-45x20x200
46mm	23mm	FRSH-46x23x200
48mm	24mm	FRSH-48x24x200
55mm	20mm	FRSH-55x20x200
55mm	27mm	FRSH-55x27x200
62mm	31mm	FRSH-62x31x200
65mm	32mm	FRSH-65x32x200
73mm	36mm	FRSH-73x36x200
80mm	40mm	FRSH-80x40x200
95mm	48mm	FRSH-95x48x200

## Solid Fluted Ferrite coress

HR4B/HR5				
O.D.	I.D.	Part No.	Tray Qty*	Box Qty
5mm	n/a	MRS-5x200	35	350
6mm	n/a	MRS-6x200	35	350
7mm	n/a	MRS-7x200	17	170
7.5mm	n/a	MRS-7.5x200	17	170
8mm	n/a	MRS-8x200	17	170
8.8mm	n/a	MRS-8.8x200	17	170
9mm	n/a	MRS-9x200	17	153
10mm	n/a	MRS-10x200	17	153
11mm	n/a	MRS-11x200	17	136
12mm	n/a	MRS-12x200	12	96
13mm	n/a	MRS-13x200	12	96
14mm	n/a	MRS-14x200	12	96
15mm	n/a	MRS-15x200	12	84
16mm	n/a	MRS-16x200	12	84
17mm	n/a	MRS-17x200	10	60
18mm	n/a	MRS-18x200	10	60
19mm	n/a	MRS-19x200	10	60
20mm	n/a	MRS-20x200	8	48
21mm	n/a	MRS-21x200	8	48
22mm	n/a	MRS-22x200	8	40
23mm	n/a	MRS-23x200	8	40
24mm	n/a	MRS-24x200	8	40
25mm	n/a	MRS-25x200	7	35
26mm	n/a	MRS-26x200	7	35
27mm	n/a	MRS-27x200	7	35
30mm	n/a	MRS-30x200	6	24

\* Please order in full tray or box quantities

Ferromax		
O.D.	I.D.	Part No.
5mm	n/a	FRS-5x200
6mm	n/a	FRS-6x200
7mm	n/a	FRS-7x200
7.5mm	n/a	N/A
8mm	n/a	FRS-8x200
8.5mm	n/a	N/A
9mm	n/a	FRS-9x200
10mm	n/a	FRS-10x200
11mm	n/a	FRS-11x200
12mm	n/a	FRS-12x200
13mm	n/a	FRS-13x200
14mm	n/a	FRS-14x200
15mm	n/a	FRS-15x200
16mm	n/a	FRS-16x200
17mm	n/a	FRS-17x200
18mm	n/a	FRS-18x200
19mm	n/a	FRS-19x200
20mm	n/a	FRS-20x200
21mm	n/a	FRS-21x200
22mm	n/a	FRS-22x200
23mm	n/a	FRS-23x200
24mm	n/a	FRS-24x200
25mm	n/a	FRS-25x200
26mm	n/a	FRS-26x200
27mm	n/a	FRS-27x200
30mm	n/a	FRS-30x200

As stated previously we also offer a range of Flat sided round ferrite cores (MRF or FRF type) and also hollow round ferrite cores (MRH or FRH). Details of sizes available and minimum order quantities can be obtained by contacting us.

### Ferrite cutting service

We offer a ferrite cutting service for small batch non-standard lengths. Because of the 'brittle' nature of the ferrite there can be breakage during cutting so pricing will reflect that. Pricing details can be supplied on request.

Ferrite diameter	Cutting price band
3mm – 6mm	Band A
7mm - 10mm	Band B
11mm – 13mm	Band C
14mm – 16mm	Band D
17mm – 20mm	Band E
21mm – 30mm	Band F

Ferrite components can be joined together using ENRX's Ferrobond™ epoxy adhesive. This ferrite powder filled epoxy maximises the magnetic permeability of the assembled components.



# Impeder casing

ENRX offers a range of different kinds of impeder casing materials

### Epoxy glass

This casing type is a high strength, glass fibre-reinforced epoxy resin composite with excellent wear properties, and extended life at high temperatures. It is widely used and is the least expensive type of casing for most impeder sizes. STE's G-11 epoxy glass will withstand temperatures 100 °F (40 °C) higher than the more common G-10 material.

### Ferroglass™

Ferroglass is a high temperature, ferrite-impregnated glass fibre tube made specifically for use in impeders. The extra ferrite in the casing can increase weld speeds by up to 40%. This improved efficiency is most noticeable at small diameters. Ferroglass also has the best wear resistance of all materials normally used in impeders.

### S300WG Casing

Our new S300WG casing is specially formulated for return flow impeders, ID scarfing impeders and the welding of tubes with challenging materials like galvanized and aluminized coatings. These S300WG casings are constructed using a special composite material in a filament winding process combined with a high temperature resin compound. The construction gives a totally homogenous structure that is water tight and mechanically robust. After the curing process, we apply a triple (3x) layer of a specially developed fluoro polymer coating (Weld Guard) giving the impeder casing a unique low friction surface. This shiny, 'slippery' surface greatly reduces the possibility of molten material adhering to the impeder exterior as well as increasing thermal endurance. The result: Higher uptime with reduced mill stops.



ENRX offers a standard range of impeder casings which are detailed on page 25. We can supply other 'custom' sizes to suit customer requirement but these will carry a minimum order quantity depending on dimensions of requested casing. Contact us for more information.

## ENRX impeder casings

Outside Diameter	Inside Diameter	LENGTH	G-11 EPOXY GLASS	FERROGLASS	S300WG
6.7mm	5.5mm	900mm	non-standard		
8.0mm	6.5mm	900mm	non-standard		
9.0mm	7.6mm	900mm	non-standard		
9.7mm	8.5mm	900mm		non-standard	
10mm	8mm	1000mm	non-standard		
10.4mm	9.2mm	900mm		non-standard	
11mm	9mm	1000mm	non-standard		
11.4mm	10.2mm	900mm		non-standard	
12mm	10mm	1000mm			
12.2mm	11mm	900mm		non-standard	
13mm	11mm	1000mm			
14mm	12mm	1000mm			
14.5mm	13mm	1000mm		non-standard	
15mm	13mm	1000mm			
15.5mm	14mm	1000mm		non-standard	
16mm	14mm	1000mm			
17mm	14mm	1000mm	non-standard		
17mm	14.5mm	1000mm		non-standard	
17mm	15.5mm	1000mm		non-standard	
18mm	15mm	1000mm			
18mm	16mm	1000mm		non-standard	
19mm	16mm	1000mm			
19mm	16.5mm	1000mm		non-standard	
20mm	17mm	1000mm			
20mm	18mm	1000mm		non-standard	
21mm	18mm	1000mm	non-standard		
22mm	19mm	1000mm			
22mm	20mm	1000mm		non-standard	
22.5mm	20mm	1000mm		non-standard	
23mm	20mm	1000mm	non-standard		
23mm	21mm	1000mm		non-standard	
24mm	21mm	1000mm			
25mm	22mm	1000mm			
26mm	24mm	1000mm			
28mm	25mm	1000mm			
28mm	25.5mm	1000mm			
29mm	27mm	1000mm			
30mm	27mm	1000mm			
30mm	28mm	1000mm			
31mm	28mm	1000mm			
32mm	28.5mm	1000mm			
34mm	30mm	1000mm			
34mm	31mm	1000mm			
37mm	34mm	1000mm			
40mm	36mm	1000mm			
40mm	37mm	1000mm			
40mm	38mm	1000mm			
43mm	40mm	1000mm			
46mm	43mm	1000mm			
50mm	46mm	1000mm			
53mm	49mm	1000mm			
57mm	49mm	1000mm			
63.5mm	57mm	1000mm			
70mm	63.5mm	1000mm			
76mm	70mm	1000mm			
89mm	82.5mm	1000mm			
51mm	25.4mm	1000mm	rectangular		

Green blocks indicate standard offering.

# Impeder & Coil cooling systems

Copper is an excellent electrical conductor but at the frequencies and power levels used for induction heating, it still has sufficient resistance to require cooling by water or mill coolant. Impeders also require cooling because they operate in close proximity to molten metal and the ferrite that they contain absorbs energy in changing its magnetic polarization, this is dissipated as heat.

Impeder and work coil cooling is particularly critical in producing small diameter tubing. Most tube mill central coolant systems do not provide sufficient pressure to properly cool impeders and induction coils, causing them to lose efficiency due to their higher operating temperatures. Return flow impeders and any impeders used with ID scarfing systems benefit particularly from use of a suitable coolant filtration and booster pump system. ENRX offers a

range of pump systems which provide a steady flow of filtered coolant for efficient operation. This increases welding efficiency and greatly reduces the downtime and cost of frequent impeder and coil replacements. These coolant systems use single or dual washable stainless-steel mesh filters and regenerative turbine pumps to boost coolant pressure thus ensuring proper cooling of even the smallest impeders and coils.

**Options**

Both CS-1c and CS-2 can be supplied with additional magnetic trap filter(s), this can be installed either before or after the mesh filter (depending on coolant condition).

The magnetic trap will catch all large and fine particles and is a fully washable assembly.

	CS-1	CS-2
Pump Type/Motor size	1HP(0.75kW)	5HP(3.0kW)
Input voltage	Single phase 230V/50Hz Europe Single phase 230V/60Hz - USA	380-440V/4.7-6.1A
Coolant connections	¾" NPT	¾" NPT
Filter type	230µ stainless steel mesh	230µ stainless steel mesh
Washable magnetic	Option of 2 x filters or 1 x filter & 1 x magnetic trap	Option of 2 of 4 filter sumps
Dimensions	610mm L x 210mm W x 458mm H	1016mm L x 458mm W x 915mm H
Weight (dry)	24Kg (53lbs)	35Kg (78lbs)



CS-1c



CS-2

# External scarfing

Our standard OD scarfing inserts are the SNMX range with 8 cutting edges. The range includes negative and positive cutting geometries and also SNMG type (our series 04). Inserts are offered in both standard and premium carbide grades. We have an insert for all materials and applications.

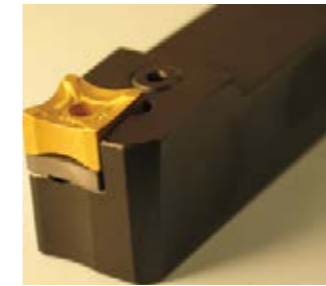

8 CUTTING EDGES

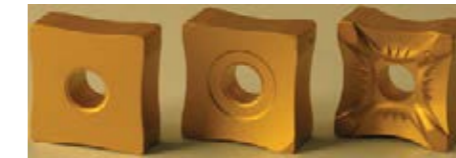

DIFFERENT GEOMETRIES



DIFFERENT SIZES

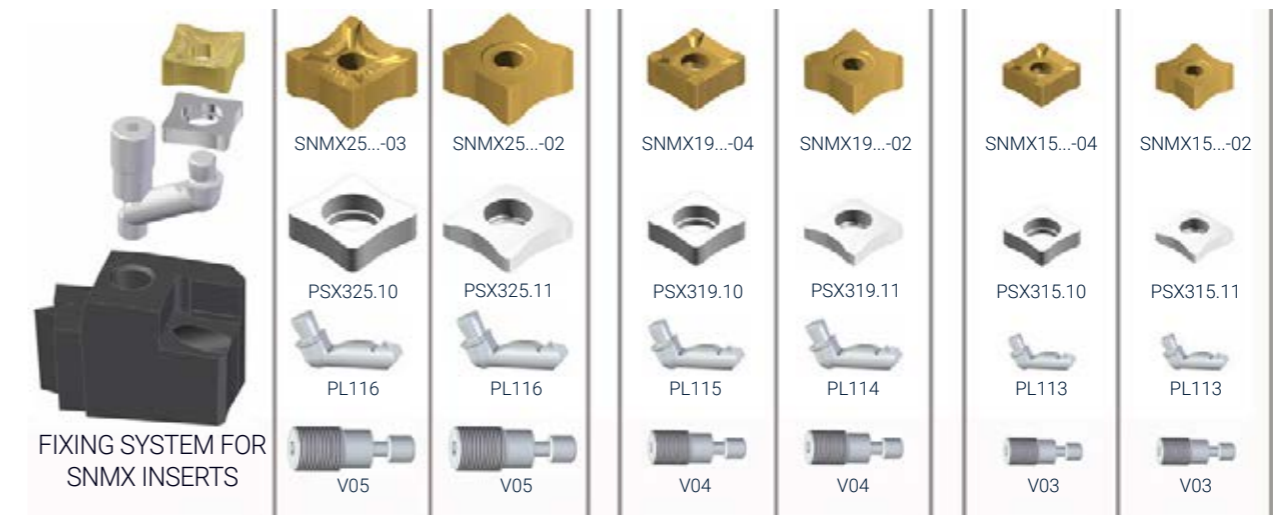

## SNMX geometry types

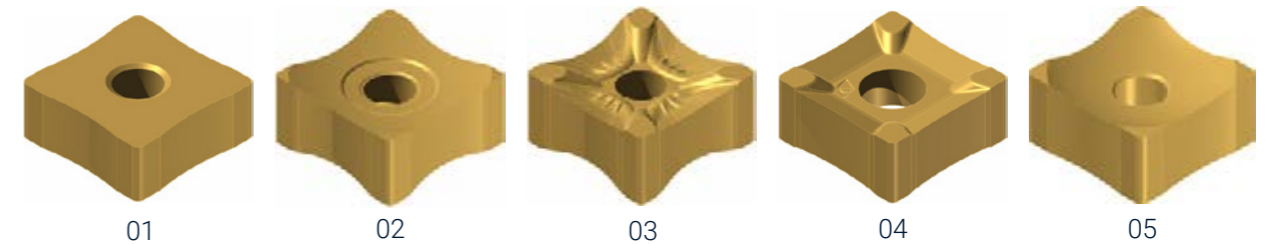

## Product code identification

e.g.: SNMX 150705-02 M813G R.20

- 15 – insert edge length 15x15mm
- 07 – insert thickness 7mm
- 05 – insert corner r=0.5mm
- 02 – insert type "02"
- M813G – carbide grade
- R.20 – radius of the cutting edge

# External scarfing

## Type of insert selection

INSERT TYPE	INSERT SIZE	GRADE P812G	GRADE D812G	GRADE P8DBC	GRADE D8DBC	BACK PLATE TYPE	RADIUS RANGE
<b>01 - NEGATIVE</b>							
SNMX150608-01	15mm					FLAT	R7-R100
SNMX190708-01	19mm					FLAT	R10-R100
SNMX250924-01	25mm					FLAT	R50-R200
<b>02 - NEGATIVE</b>							
SNMX150705-02	15mm					CURVED	R7-R100
SNMX190808-02	19mm					CURVED	R10-R100
SNMX251224-02	25mm					CURVED	R50-R200
<b>03 - POSITIVE WITH CHIPBREAKER</b>							
SNMX150705-03	15mm					FLAT	R20-R60
<b>04 - POSITIVE (SNMG TYPE)</b>							
SNMX150705-04	15mm					FLAT	R7-R100
SNMX190808-04	19mm					FLAT	R9-R100
SNMX251224-04	25mm					FLAT	R50-R200
<b>05 - SUPER POSITIVE</b>							
SNMX150705-05	15mm					FLAT	R9-R60

P812G & D812G - Premium carbide grades  
 P8DBC & D8DBC - Top quality carbide with additional coating

## Radius choice

The recommended insert radius can be found in the following tables. The radius varies depending on the range of the tube diameters and insert type. Please note that this is only a guide and certain preferences can mean a slightly different selection to the values below.



TUBE DIAMETER		RADII	TUBE DIAMETER		RADII
NEGATIVE TYPE MIN=MAX	POSITIVE TYPE MIN=MAX	r	NEGATIVE TYPE MIN=MAX	POSITIVE TYPE MIN=MAX	r
8÷13.5	8÷13.5	7	49÷53	45÷50	27
13.5÷17	12.5÷16	9	53÷59	50÷54	30
17÷21	16÷20	11	59÷69	54÷62	35
21÷25	20÷24	13	69÷79	62÷70	40
25÷29	24÷28	15	79÷89	70÷78	45
29÷35	28÷33	18	89÷99	78÷85	50
35÷39	32÷37	20	99÷149	85÷120	75
39÷43	37÷41	22	149÷198	120÷150	100
43÷49	41÷45	25			

## Other solutions for external scarfing

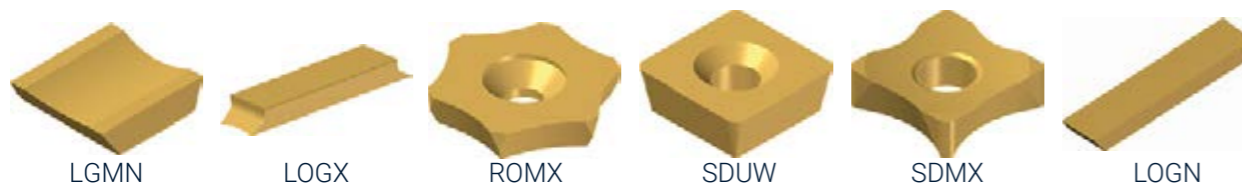

# External scarfing

## SNMX toolholders

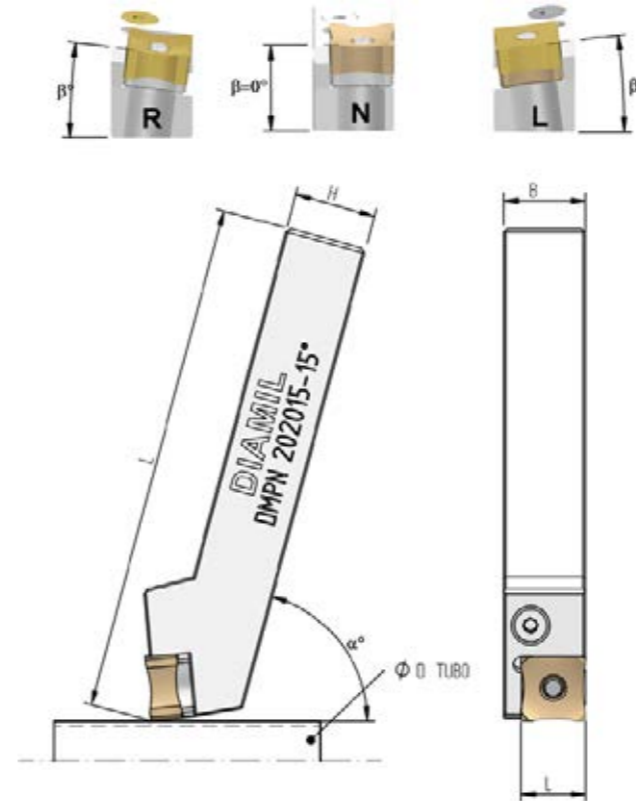

## Toolholders dimensions table

TOOLHOLDER CODE	BxH	L	SUITABLE INSERT
DMP N/R/L 202015-90	20x20	125	SNMX 15
DMP N/R/L 202015-75	20x20	125	
DMP N/R/L 252515-90	25x25	150	
DMP N/R/L 252519-90	25x25	150	SNMX 19
DMP N/R/L 323219-75	32x32	170	
DMP N/R/L 323225-75	32x32	170	SNMX 25

In addition to standard tool holders we can offer custom made versions to suit specific requirements. In this case please provide details from the table below.

DIMENSIONS	DESCRIPTION
B	SHANK WIDTH
H	SHANK HEIGHT
L	SHANK LENGTH
15/19/25	INSERT DIMENSIONS
$\beta^\circ$	TOP RAKE ANGLE
$\alpha^\circ$	HEAD INCLINATION (75° or 90°)
R/N/L	DIRECTION (RIGHT/NEUTRAL/LEFT)

## Other tube processing applications

We offer a wide range of other tube machining/processing inserts and tool holders. This includes edge milling for large diameter HF and SAW mills, end chamfering and custom designed solutions for special demands.

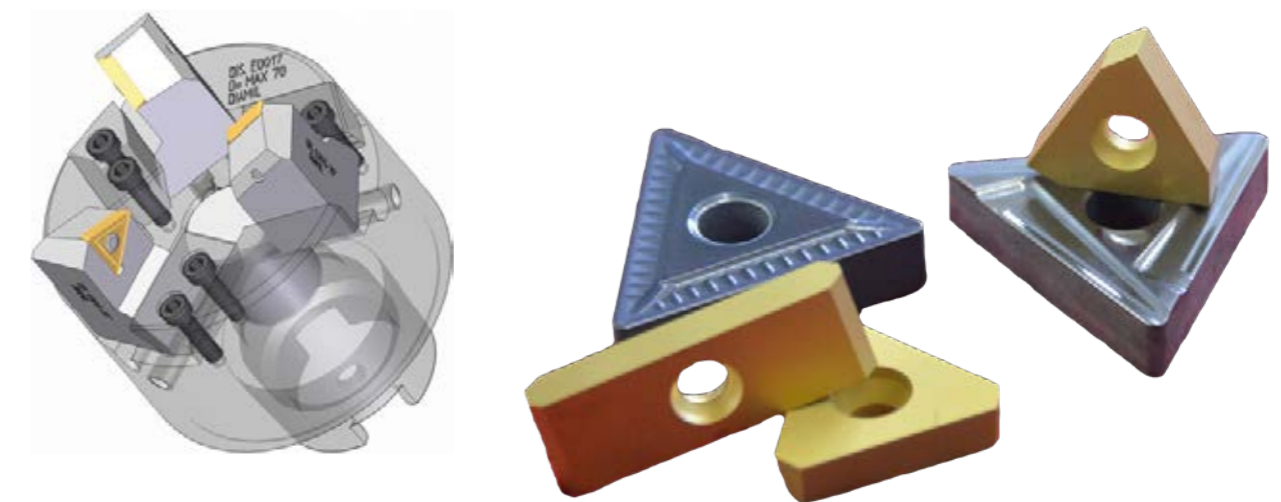

# Internal scarfing

## Cutting rings



ENRX offers the full range of hard metal rings for internal scarfing which are available in two angles: 42° (general purpose) and 48°(Aluminized tubes), available in different carbide grades and coatings.

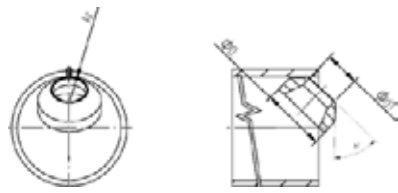

CODE	WORKING RANGE	D	CODE	WORKING RANGE	D
SR0 AR4,5	14÷17	8	SR3 AR14	32÷41	22
SR0 AR5,5	16÷17		SR3 AR17	41÷50	
SR0 AR6,0	16÷19	10	SR4 AR23	48÷72	30
SR0 AR6,5	17÷20		SR5 AR25	70÷85	
SR1 AR07	20÷22	13	SR5 AR28	85÷100	35
SR1 AR08	22÷24		SR6 AR30	90÷110	
SR1 AR09	24÷26	19	SR6 AR34	100÷130	45
SR2 AR10	26÷28		SR7 AR39	125÷160	
SR2 AR11	28÷30	19	SR8 AR46	150÷260	55
SR2 AR12	30÷34				



## Other solutions for internal scarfing

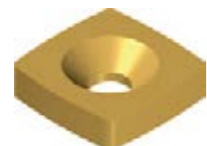

SNMW

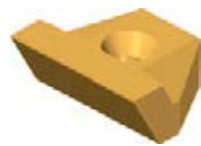

TEMX

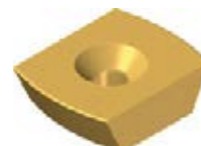

LOMX

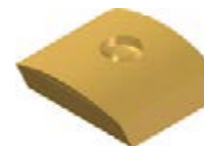

LFGX

## Bespoke internal scarfing tool holders

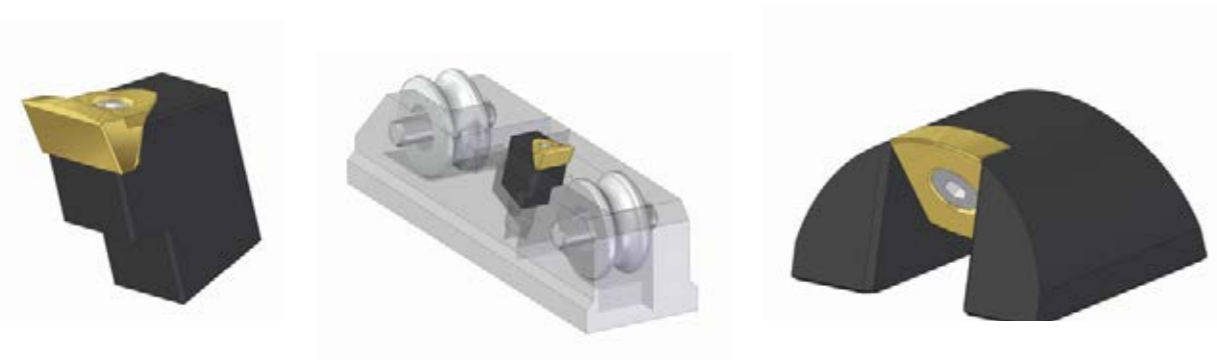

# Canticut ID scarfing system

Canticut is ENRX's innovative ID scarfing system for large diameter pipe and tube. Typically Canticut is only suitable for diameters from 114mm upwards. The unique heavy duty design enables quick set up, precision control, and reliability. All position and cut depth controls are easily accessible to the operator between the last fin pass and weld box, external of the pipe I.D. Supporting the scarfing tool on a cantilever removes the need for internal rolls. This key feature ensures the mandrel covers a wide range of pipe sizes and eliminates the problem of rolling weld spume or other particles into the tube wall.

A Canticut unit can ID scarf pipe sizes ranging from 4.5" - 26" (114 - 660 mm) O.D. using only two mandrels. Canticut ID scarfing systems are used by many of the world's leading tube and pipe producers. Due to

its ability to meet the critical demands for energy efficient production, Canticut ID scarfing systems are considered the "gold standard" for tube, pipe and casing manufacturing. Recent improvements include a hydraulically actuated bead chopper to cut the stringer into manageable lengths for easy removal from the pipe. The use of newer high strength alloys results in mandrels with increased rigidity and strength, while reducing weight and allowing more space to be used for ENRX impeders and impeder clusters. The heavily fabricated mounting stand is now available with position sensors including outputs to PLC/ HDMI for precise repeatability, and to efficiently optimize set up time. Interchangeable tool holders and bead chopping heads greatly reduce mill down-time and permit the use of a wide variety of cutting tool styles to suit different grades of material as well as user preferences.

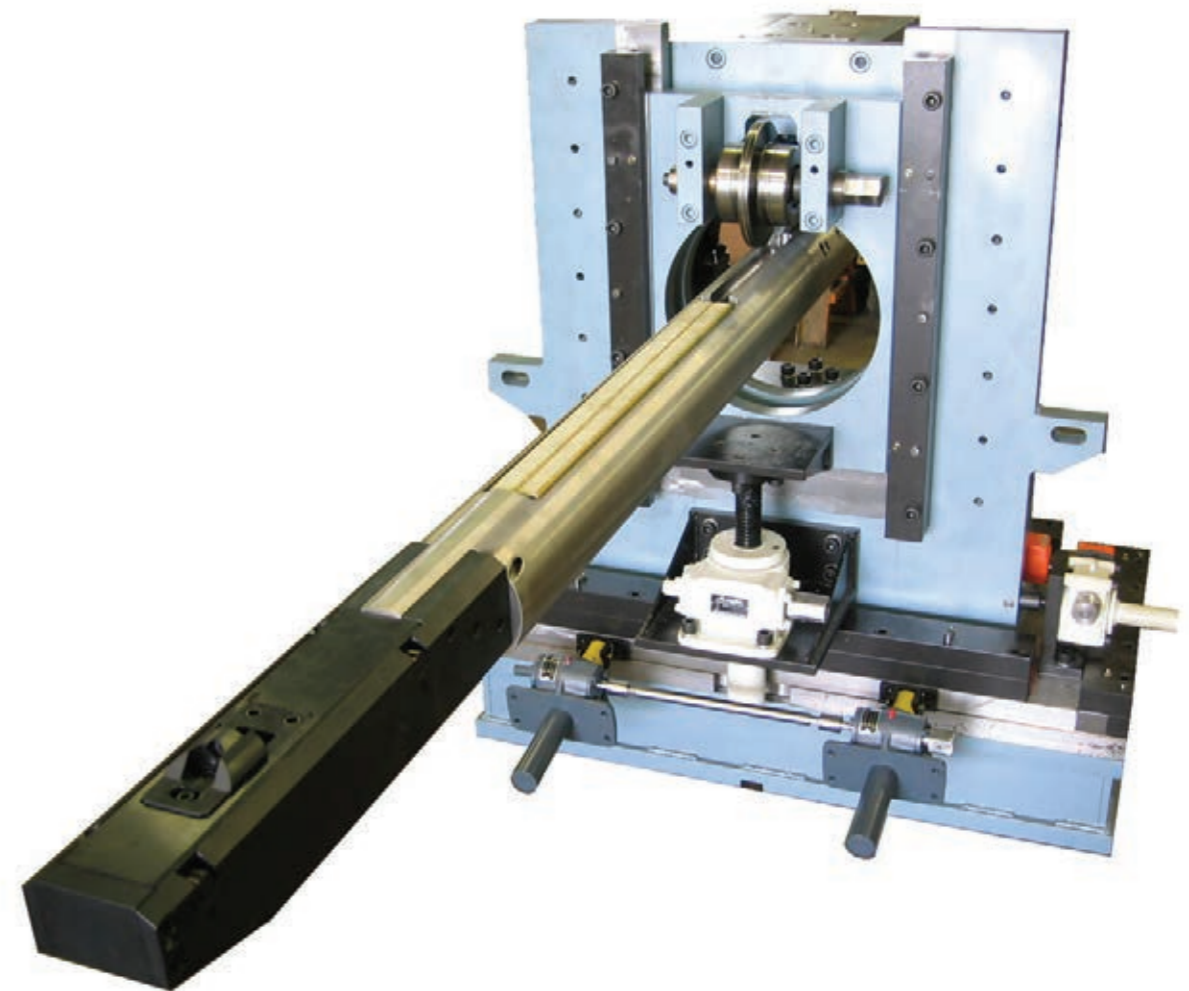





# Notes Pages

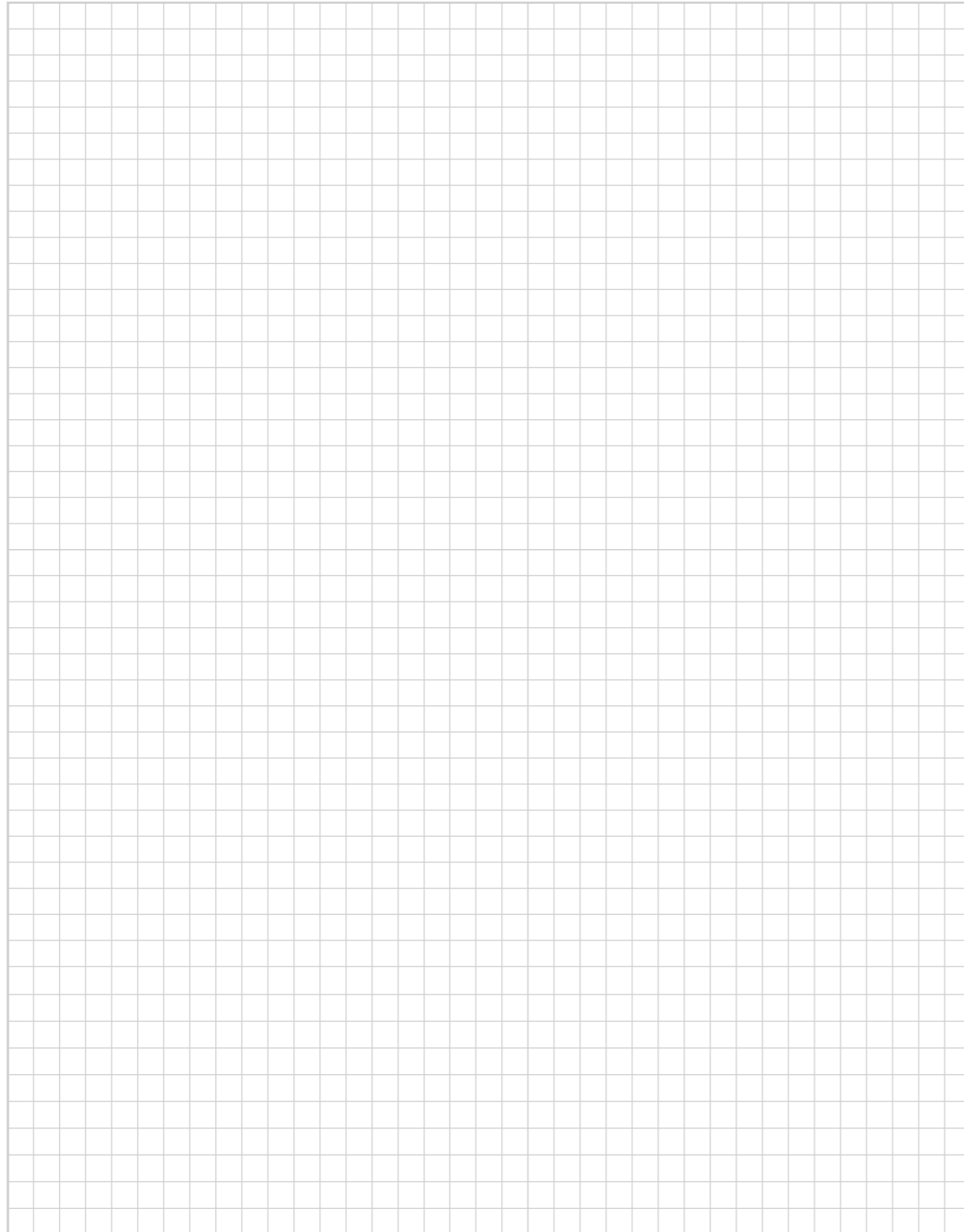

# Notes Pages

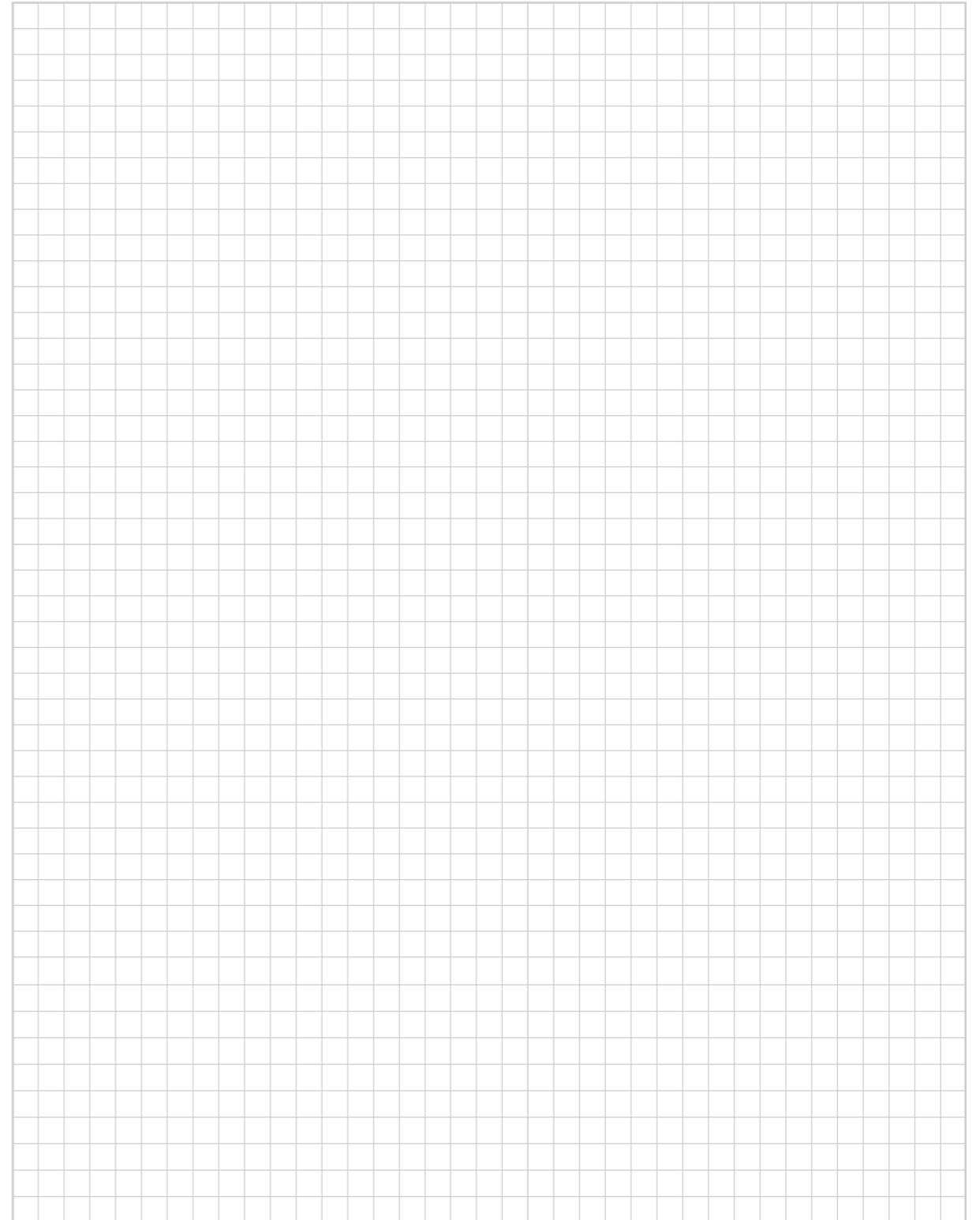

## Get more from your equipment

ENRX welding consumables give you security and peace of mind by ensuring repeatable high quality, time after time. We carefully select and use only the best materials and products to make sure our customers processes remain stable from one production run to the next.

We only promote and sell products that help you improve your production, reduce operating costs and increase your efficiency. For all kinds of consumables for tube & pipe welding we can bring a dedicated solution to your business.

ENRX is a new brand with decades of experience in induction heating, wireless inductive charging and contactless power supply with a new modern impeder manufacturing plant in Poland. ENRX is the largest induction heating supplier in Europe and operates full manufacturing plants and service centres at 20 locations around the world.

**Learn more about the ENRX solutions that are boosting productivity for companies around the world: [www.enrx.com](http://www.enrx.com)**

