



Ömür Boyu
Enerji Verimliliği



Şirket Profili

Misyonumuz:

Sahip olduğumuz girişimci ruhumuzla yurt içinde ve yurt dışında evrensel kalitede ürün ve hizmetler üreterek, ülke ekonomisine doğrudan katkıda bulunmak ve yeni iş olanakları oluşturmak.

Vizyonumuz:

Önümüzdeki yıllarda kendini dahada hissettirecek yeni global dünya düzeni içinde, sektörümüzde söz sahibi kurum ve kuruluş olarak Türkiye'yi çok daha güçlü temsil etmek.

Our mission:

To contribute directly country's economy and to create new business opportunities by producing services and goods at home and abroad at global quality with our entrepreneurial spirit.

Our vision:

To represent our country more powerfully as a leading company and organisation in its sector in the new world order which will be felt deeper in coming years.

مهمتنا

مع روح المبادرة التي لدينا في داخل و خارج البلاد لدينا الجودة العالمية لأنتاج المنتجات و الخدمات تسهم بشكل مباشرة في اقتصاد البلاد و خلق فرص عمل جديدة

الرؤية

نظام العالمي الجديد في السنوات المقبلة مع قطاعنا الموجودة في تركيا المؤسسات والمنظمات التي أختيرت ستمثل تركيا بشكل أقوى

كۆمىشىن

بەو دەست پىتەخىشەرىكى كە لە ناو وولات و دەرەوھى وولات ھەمانە لە جۆرى جىھانى كە بەرھەم ھىنانى بەھەم و خزمەتە، ھاوبەش دەبىت بە شىئوھىكى راستەوخۆ لە ئابوورى وولات بۆ دابىن كۆردنى كارى ئوئى

بىنايى

لە سىستەمى ئوونى جىھانى لە سالانى داھاتوو لەگەڵ پىرەمکانمان كە لە توركيا دان دەزگاكان و رىكەخراومان كە ھەلبەت ئىزدراون بە شىئوھىكى بەھتەتر ئوونەرايەتى توركىيا دەكەن

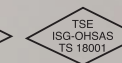
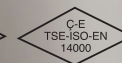
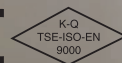

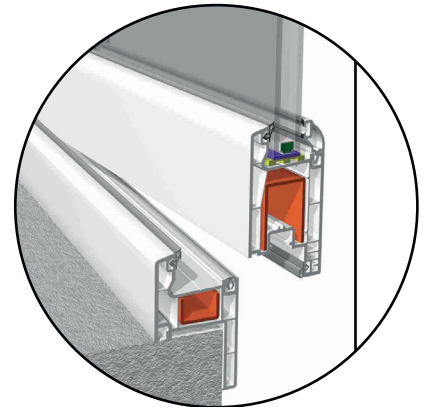
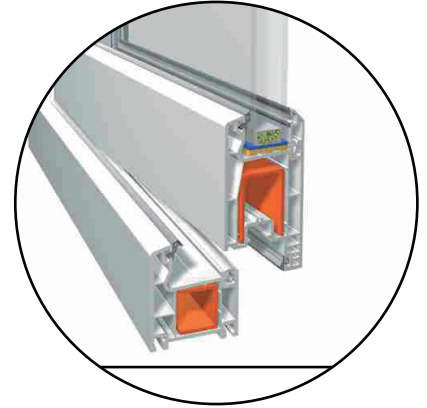
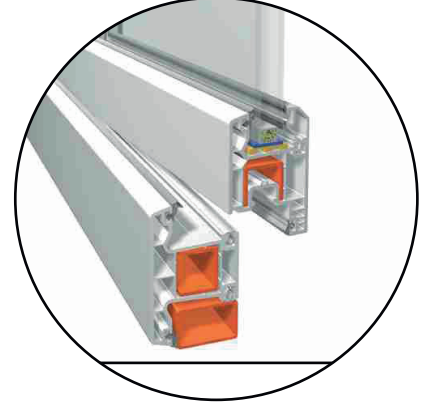

- 1** Kir tutmayan vektörel dış yüzey
- 2** (4+16+4) 24 mm, (4+12+4) 20 mm, 4 mm cam uygulanabilecek cam boşluğu ve çita sistemleri
- 3** Açılı vektörel, tek tırnaklı çita
- 4** Standartlara uygun ispanyolet yatağı
- 5** Kanat içi gizli conta
- 6** Kendinden gri conta
- 7** Yüksek mukavemetli, sıcak daldırma, galvanizli, çelik destek sacı
- 8** Su tahliyesini kolaylaştırıcı eğim
- 9** Yalıtım artıran 3 odacık
- 10** Tek tırnak çita yuvası



**Ahşap Desenli
Folyo Kaplama
Renkler**

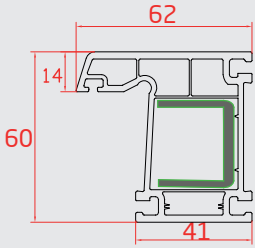

KASA
(Frame Profile)

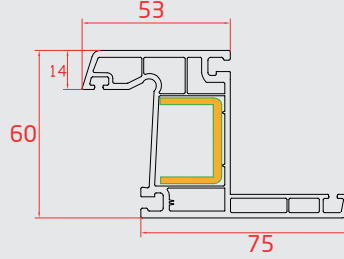

PERVAZLI KASA
(Case Profile With Frame)

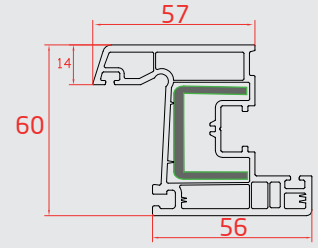

KANAT
(Sash Profile)

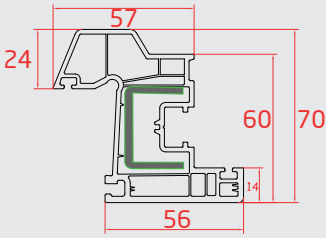

DAMLALIKLI KANAT
(Self Drainage Sash Profile)

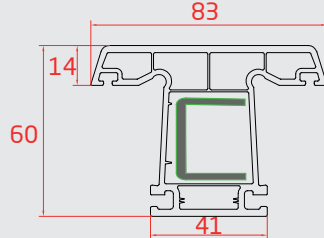

ORTA KAYIT
(Mullion Profile)

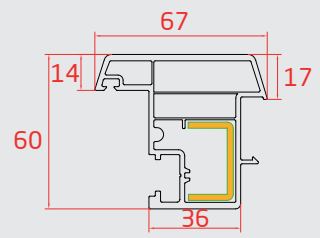

HAREKETLİ ORTA KAYIT
(Overhung Profile)

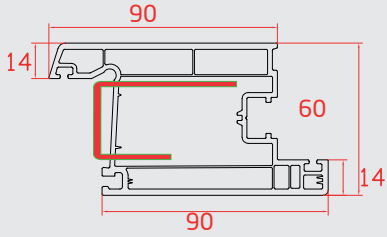

İÇE AÇILIR KAPI
(Door Sash Profile)

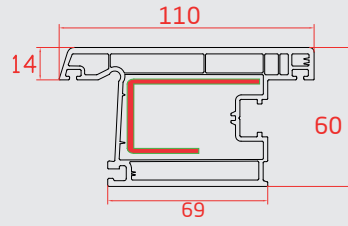

DİŞA AÇILIR KAPI
(Outward Opening Door Sash Profile)

ÇİTA DETAYLARI

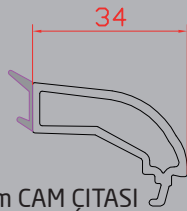

4mm CAM ÇİTASI
(Single Glass Lath)

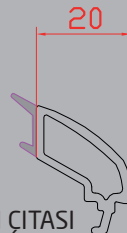

20mm CAM ÇİTASI
(Double Glass Lath)

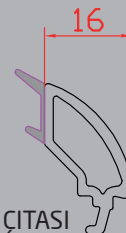

24mm CAM ÇİTASI
(Double Glass Lath)

DESTEK SACI DETAYLARI

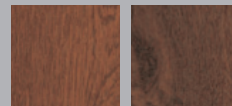
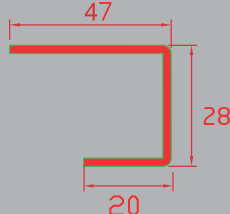
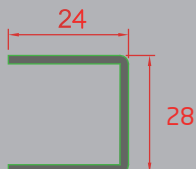
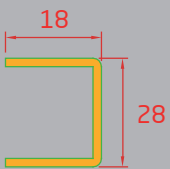

**Ahşap Desenli
Folyo Kaplama
Renkler**

ÜRÜN RENKLERİ GERÇEK RENKLERE YAKIN OLMAKLA BİRLİKTE, BASKI İŞLEMLERİ NEDENİYLE FARKLILIKLAR OLUŞABİLİR

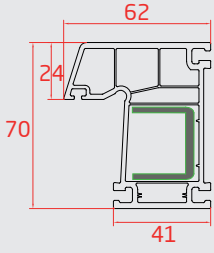

KASA
(Frame Profile)

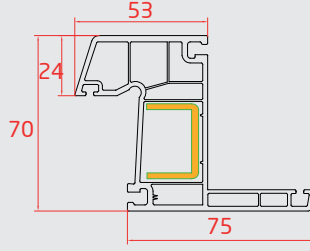

PERVAZLI KASA
(Case Profile With Frame)

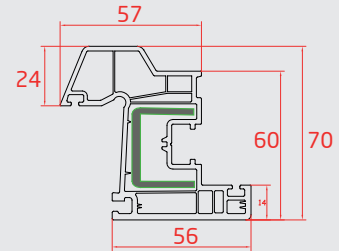

DAMLALIKLI KANAT
(Self Drainage Sash Profile)

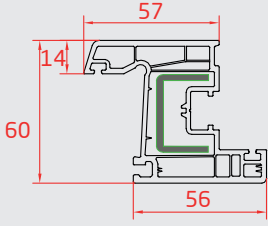

KANAT
(Sash Profile)

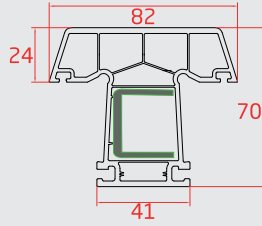

ORTA KAYIT
(Mullion Profile)

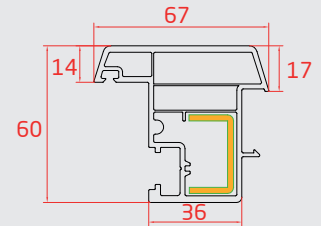

HARAİETLİ ORTA KAYIT
(Overhung Profile)

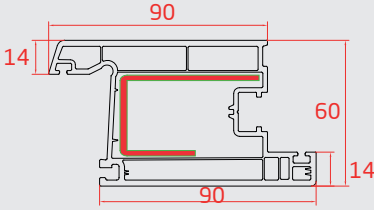

İÇE AÇILIR KAPI
(Door Sash Profile)

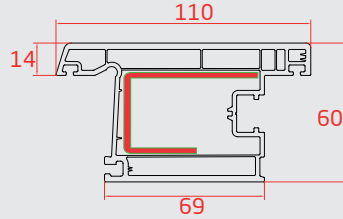

DİŞA AÇILIR KAPI
(Outward Opening Door Sash Profile)

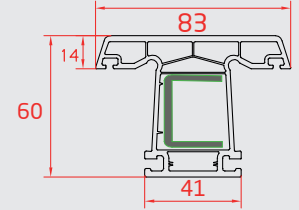

KAPI İÇİ ORTA KAYIT
(Door Sash Mullion Profile)

ÇİTA DETAYLARI

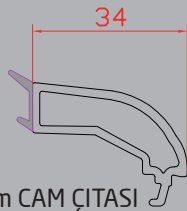

4mm CAM ÇİTASI
(Single Glass Lath)

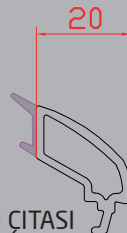

20mm CAM ÇİTASI
(Double Glass Lath)

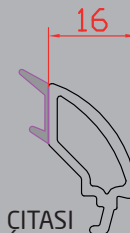

24mm CAM ÇİTASI
(Double Glass Lath)

DESTEK SACI DETAYLARI

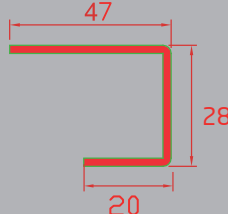
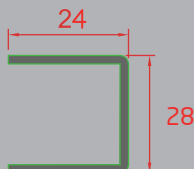
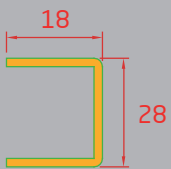

**Ahşap Desenli
Folyo Kaplama
Renkler**

ÜRÜN RENKLERİ GERÇEK RENKLERE YAKIN OLMAKLA BİRLİKTE, BASKI İŞLEMLERİ NEDENİYLE FARKLILIKLAR OLUŞABİLİR

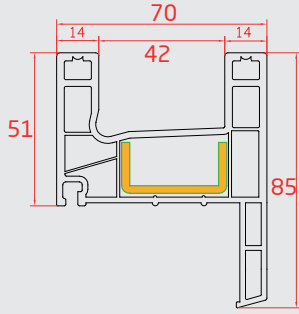

SÜRME PERVAZLI KASA
(Case Profile With Frame)

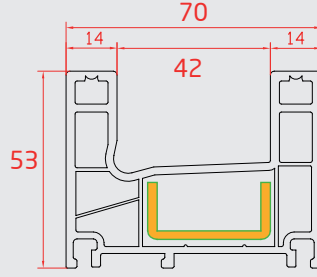

SÜRME KASA
(Sliding Frame Profile)

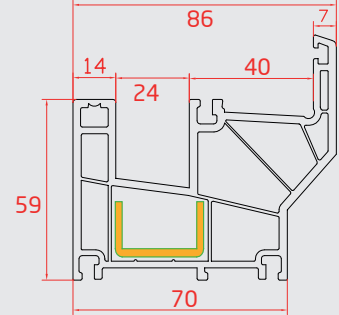

SÜRME TEKLİ KASA
(Fixed Frame Slider)

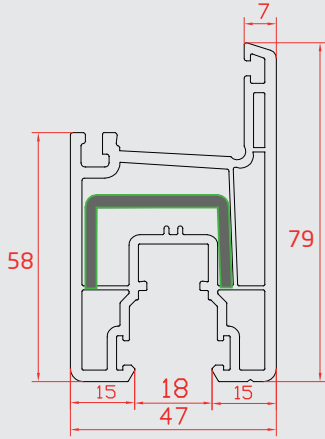

KANAT
(Sliding Sash Profile)

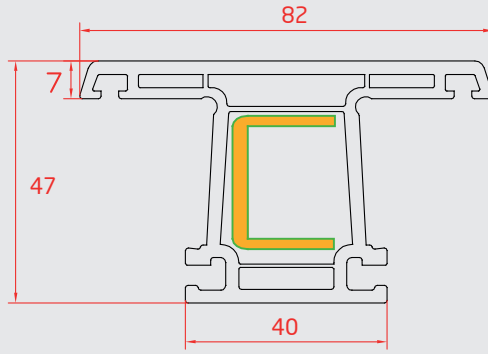

ORTA KAYIT
(Mullion Profile)

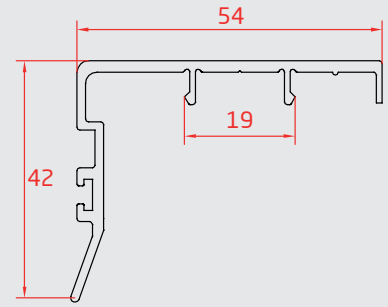

SÜRME ALIN KAPAMA
(Interlocking Profile)

ÇITA DETAYLARI

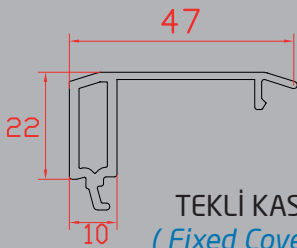

TEKLİ KASA KAPAMA
(Fixed Cover Profile)

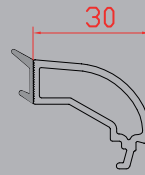

4mm CAM ÇITASI
(Single Glass Lath)

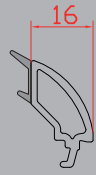

20mm CAM ÇITASI
(Double Glass Lath)

DESTEK SACI DETAYLARI

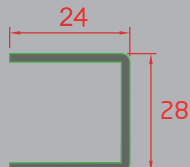
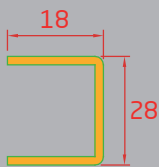

Ahşap Desenli
Folyo Kaplama
Renkler

ÜRÜN RENKLERİ GERÇEK RENKLERE YAKIN OLMAKLA BİRLİKTE, BASKI İŞLEMLERİ NEDENİYLE FARKLILIKLAR OLUŞABİLİR

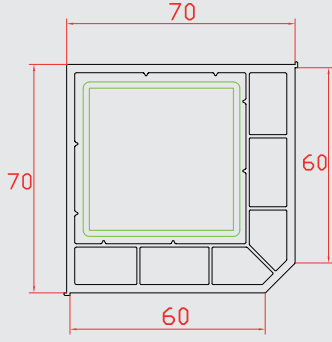

60 - 70 KUTU
(Rectangle Profile)

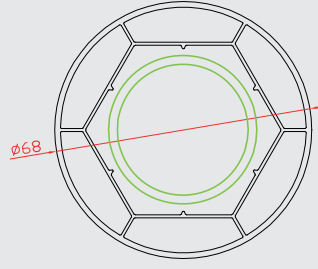

BORU
(Pipe Profile)

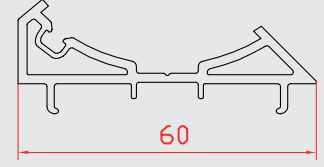

60 mm BORU ADAPTÖRÜ
(Corner Adapter)

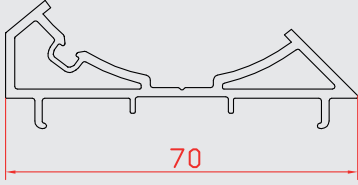

70 mm BORU ADAPTÖRÜ
(Corner Adapter)

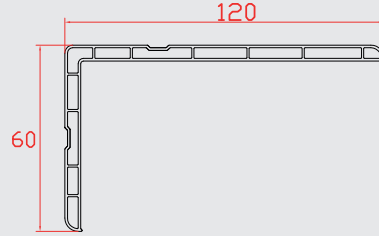

60x120 mm PERVAZ
(Sill Joint Extension Profile)

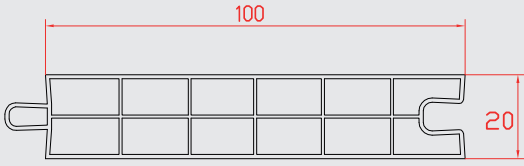

100mm LAMBRİ
(Two Chamber Panel Profile)

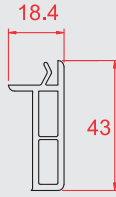

KASA DAHİLİ PERVAZ
(Internal Frame Extension)

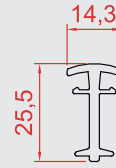

FİX BAĞLANTI
(Coping Profile)



ÇITA YUVA KAPAMA
(Canal Covering Profile)

DESTEK SACI DETAYLARI

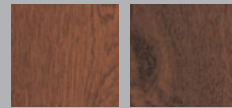
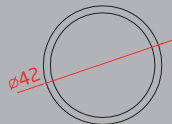
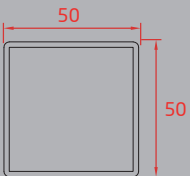

Ahşap Desenli
Folyo Kaplama
Renkler

ÜRÜN RENKLERİ GERÇEK RENKLERE YAKIN OLMAKLA BİRLİKTE, BASKI İŞLEMLERİ NEDENİYLE FARKLILIKLAR OLUŞABİLİR

 **ASYAPEN**



DOĞA DOSTU

ADANA MERKEZ : Hacı Sabancı Organize Sanayi Bölgesi , Abdullah Gül Bul No:22 Sarıcam/ADANA
tel : 0 322 234 40 80 - 235 90 80 - 394 42 20 - fax : 0 322 234 03 80 - E-mail: info@maxwin.com.tr

Güneydoğu Bölge : Aydınlar Mahallesi 03045 Nolu Sokak No 10 GAZİANTEP
tel: 0342 328 94 14 pbx - fax: 0342 328 94 17

www.asyapen.com