



Bağlama Ekipmanlarında Kalite Üretiyoruz..

*We produce quality in clamping equipment..*

*Wir produzieren qualität in der spanntechnik..*

# KALIP YÜKLEME TABLASI

Mold Transport Tray

Werkzeugtransportplatte

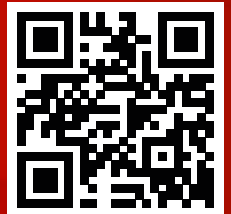



# Kalıp Yükleme Tablası

- TR**
- Ağırılığı 1 tona kadar olan kalıpları, pres tablasına veya raflara yerleştirmek için yükleme esnasında hareket ettirilmek istendiğinde, yüzey temasını azaltır. Böylece rahatlıkla, çok fazla güce ihtiyaç duymadan hızlı ve pratik şekilde kalıbı yükleme olanağı sağlamaktadır.
  - Kalıp arabasına veya forklift araçlarına montaj özelliği ile birlikte kolaylıkla sabitlenip kullanılabilir.

## EN Mold Transport Tray

- Molds up to 1 ton weight, it reduces surface contact when it is desired to be moved during loading to be placed on the press table or shelves. Thus, it provides the possibility of loading the mold easily and quickly without the need for much power.
- It can be mounted on mold cart or forklifts and can be easily used.

## DE Werkzeugtransportplatte

- Für Werkzeuge bis zu einem Gewicht von 1 Tonne geeignet. Er reduziert den Oberflächenkontakt, wenn das Werkzeug während der Beladung bewegt werden soll, um auf den Pressentisch oder ins Regal zu platzieren. So bietet es die Möglichkeit, das Werkzeug einfach und schnell ohne großen Kraftaufwand zu beladen.
- Sie kann auf Werkzeugwagen oder Gabelstaplern montiert werden und ist einfach zu bedienen.

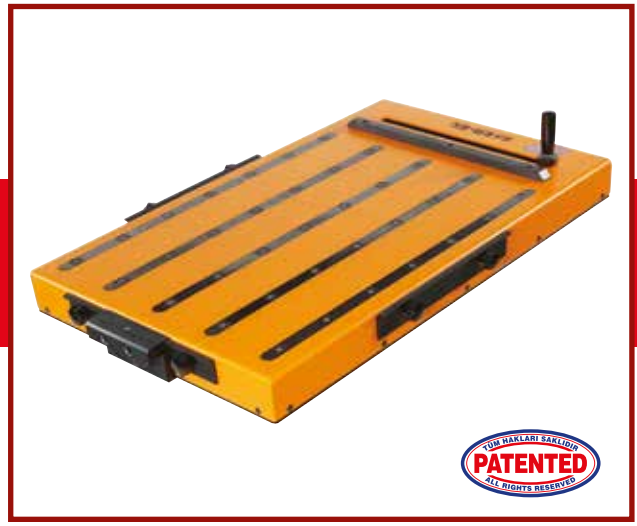

Referans Nr. Order No Referenz Nr.	A	L2	H	L	Kapasite Capacity Kapazität
1024-500670	500	670	71	818	1 Ton 1Tonne

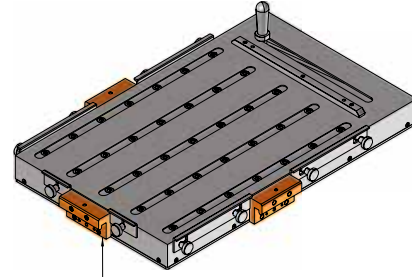

Hizalama Kancası Ön ve Yan Yüzelere Montajlanabilir.

It can be mounted on the front and side surfaces.  
Ausrichthaken Auf vordere und seitliche Flächen kann es montiert werden.

Taşıma Arabası ve Benzer Ekipmanlar İçin Montaj Delikleri  
Mounting Holes For Transport Tray and Similar Equipment  
Montagelöcher für Transportwagen oder ähnliche Systeme

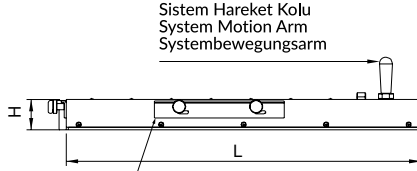

Dört Taraflı Emniyet Stoperi  
Four-Sided Safety Stopper  
Sicherheitsanschläge auf 4 Seiten

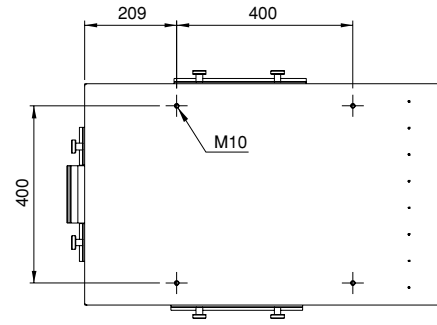
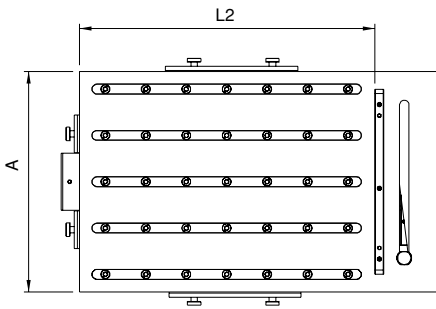

## Kalıp Yükleme Tablası Uygulamaları / Mold Transport Tray Applications / Anwendungsbeispiele für Werkzeugwechselwagen

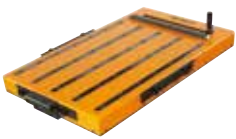

Kalıp Yükleme Tablası  
Mold Transport Tray  
Werkzeugtransportplatte



Kalıp Yükleme Tablası (Arabası)  
Mold Transport Tray (Trolley)  
Werkzeugwechselwagen



Kalıp Yükleme Tablası (Elektrikli Forklift)  
Mold Transport Tray (Electric Forklift)  
Elektrischer Werkzeugwechselwagen



Kalıp Yükleme Tablası (Forklift)  
Mold Transport Tray (Forklift)  
Werkzeugwechselwagen (Gabelstapler)



Uygulama videosu için kare kodu okutun  
Scan the QR code for the application video  
Scannen Sie bitte den QR-Code für das Applikations video

# Kalıp Yükleme Tablası (Arabalı)

**TR** Ağırlığı 1 tona kadar olan kalıpları, pres tablasına veya raflara yerleştirmek için yükleme esnasında hareket ettirilmek istendiğinde, yüzey temasını azaltır. Böylece rahatlıkla, çok fazla güce ihtiyaç duymadan hızlı ve pratik şekilde kalıbı yüklemeye olanağı sağlamaktadır.

## **EN** Mold Transport Tray (Trolley)

Molds up to 1 ton weight, it reduces surface contact when it is desired to be moved during loading to be placed on the press table or shelves. Thus, it provides the possibility of loading the mold easily and quickly without the need for much power.

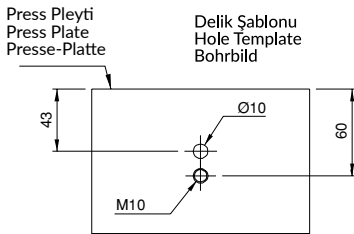
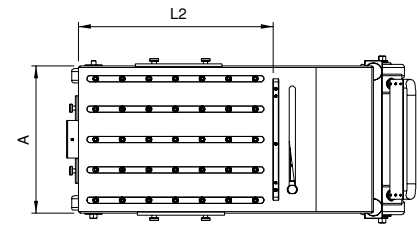
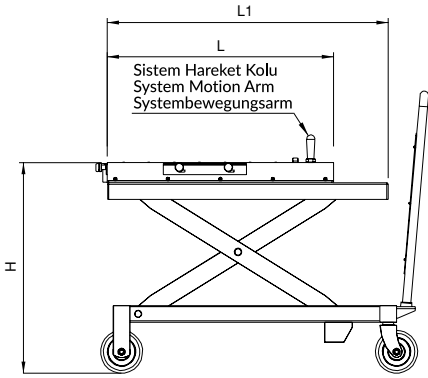

## **DE** Werkzeugwechselwagen

Für Werkzeuge bis zu einem Gewicht von 1 Tonne geeignet. Er reduziert den Oberflächenkontakt, wenn das Werkzeug während der Beladung bewegt werden soll, um auf den Pressentisch oder ins Regal zu platzieren. So bietet es die Möglichkeit, das Werkzeug einfach und schnell ohne großen Kraftaufwand zu beladen.

Referans Nr. Order No Referenz Nr.	A	L2	H (min. - max.)	L	L1	Kapasite Capacity Kapazität
1024-500671	500	670	480 - 1050	818	1015	1 Ton 1 Tonne

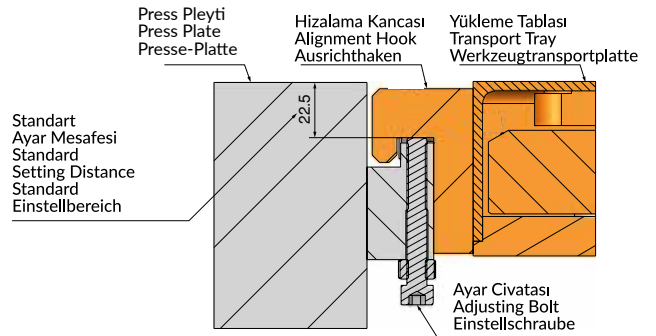

1

2

3

4

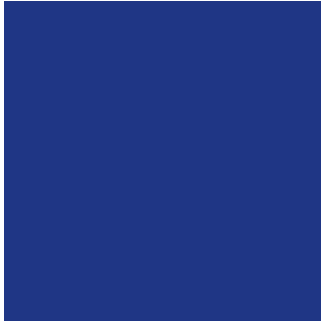
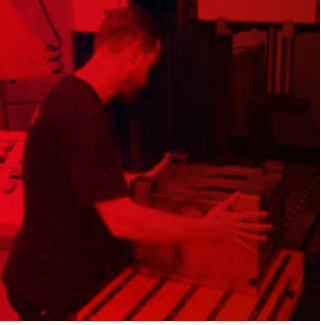

## KALIP YÜKLEME TABLASI (ARABALI)

Mold Transport Tray (Trolley)  
Werkzeugwechselwagen



# ER-EL®

Bağlama Ekipmanlarında Kalite Üretiyoruz..  
We produce quality in clamping equipment..  
Wir produzieren qualität in der spanntechnik..

ER-EL MAKİNA YEDEK PARÇA İML. SAN. VE TİC. LTD. ŞTİ.  
Çerkeşli OSB Mah. İMES 3 Blv. No: 14 Dilovası - Kocaeli  
Tel / Phone: +90 262 502 11 60 Pbx Fax: +90 262 502 11 59  
info@er-el.com.tr www.er-el.com.tr

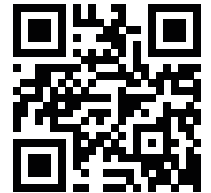

f erelkalip  
miksancamp

t ERELkalip  
ClampMiksanc

y erelkalip  
miksancamp

ig erelkalip  
miksancamp

in er-el-kalip  
miksancamp